

200mA PCI LDO

Features

- Glitch Free Transition Between Input Sources
- Automatic Input Source Selection
- External PMOS Bypass Switch Control
- Built-in 5V Detector
- 1% Regulated Output Voltage Accuracy
- 200mA Load Current Capability
- Kelvin Sense Input
- Low Dropout Voltage (240mV @ Full Load)
- Low Ground Current, Independent of Load

Applications

- PCMCIA
- PCI
- Network Interface Cards (NICs)
- Cardbus™ Technology

Device Selection Table

Part Number	Package	Junction Temp. Range
TC1266VOA	8-Pin SOIC (Narrow)	-5°C to +125°C
TC1266VUA	8-Pin MSOP	-5°C to +125°C

Package Type

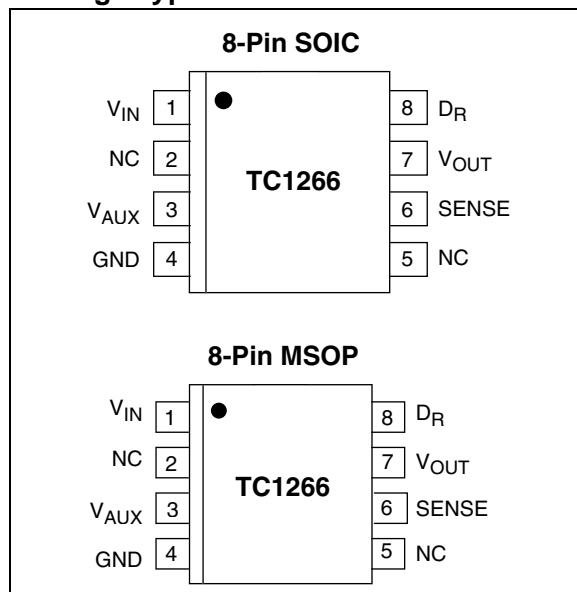

General Description

The TC1266 is an application-specific, low dropout regulator (LDO), specifically intended for use in PCI peripheral card applications complying with PCI Power Management (PCI 2.0). It provides an uninterrupted, 3.3V, 200mA (max) output voltage when the main (5V) or auxiliary (3.3V) input voltage supplies are present.

The TC1266 consists of an LDO, a voltage threshold detector, external switchover logic and gate drive circuitry. It functions as a conventional LDO as long as the voltage on the main supply input (V_{IN}) is above the lower threshold (3.90V typical). Should the voltage on V_{IN} fall below the lower threshold, the LDO is disabled and an external P-channel MOSFET is automatically turned on, connecting the auxiliary supply input to V_{OUT}, and ensuring an uninterrupted 3.3V output. The main supply is automatically selected, if both the main and auxiliary input supplies are present, and transition from one input supply to the other is ensured glitch-free. High integration, automatic secondary supply switchover, Kelvin sensing, and small size make the TC1266 the optimum LDO for PCI 2.0 applications.

Functional Block Diagram

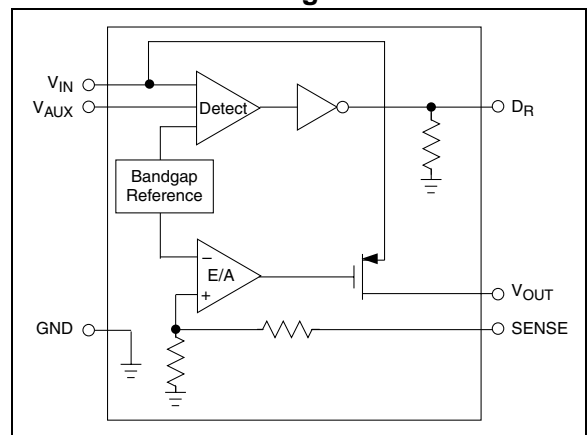

TC1266

1.0 ELECTRICAL CHARACTERISTICS

Absolute Maximum Ratings*

Input Supply Voltage (V_{IN}).....-0.5V to +7V (Max)
 Auxiliary Supply Voltage (V_{AUX})-0.5V to +7V (Max)
 LDO Output Current (I_{OUT}).....200mA
 Thermal Impedance,
 Junction-to-Ambient (θ_{JA})..... 130°C/W for SOIC
 ESD Rating 2 KV
 Operating Temperature Range (T_A).....-5°C to +70°C
 Storage Temperature Range (T_{STG})...-65°C to +150°C

*Stresses above those listed under "Absolute Maximum Ratings" may cause permanent damage to the device. These are stress ratings only and functional operation of the device at these or any other conditions above those indicated in the operation sections of the specifications is not implied. Exposure to Absolute Maximum Rating conditions for extended periods may affect device reliability.

TC1266 ELECTRICAL SPECIFICATIONS

Electrical Characteristics: $T_A = +25^\circ\text{C}$, $V_{IN} = 5\text{V}$, $V_{AUX} = 3.3\text{V}$, $I_{OUT} = 0.1\text{mA}$, $C_{OUT} = 4.7\mu\text{F}$, unless otherwise noted. Boldface type specifications apply over full operating temperature range.						
Symbol	Parameter	Min	Typ	Max	Units	Test Conditions
V_{IN}	Supply Voltage	4.3	5.0	5.5	V	$V_{AUX} = 0\text{V}$
I_{GND}	Ground Current	—	230	450	μA	$V_{AUX} = 0\text{V}$ (Note 6) $V_{AUX} = 3.3\text{V}$ (Note 6)
I_{VIN}	Reverse Leakage from V_{AUX}	—	-0.1	-1.0	μA	$V_{AUX} = 3.6\text{V}$, $V_{IN} = 0\text{V}$, $I_{OUT} = 0\text{mA}$
V_{AUX}	Supply Voltage	3.0	3.3	3.6	V	
$I_{Q(AUX)}$	Quiescent Current	—	50	70	μA	$V_{IN} = 0\text{V}$, $I_{OUT} = 0\text{mA}$
		—	—	100		
		—	60	80	μA	$V_{IN} = 5\text{V}$, $I_{OUT} = 0\text{mA}$
		—	—	120		
I_{VAUX}	Reverse Leakage from V_{IN}	—	-0.1	-1.0	μA	$V_{IN} = 5.5\text{V}$, $V_{AUX} = 0\text{V}$, $I_{OUT} = 0\text{mA}$
$V_{TH(LO)}$	5V Detector	—	3.90	—	V	V_{IN} Falling (Notes 2, 3)
	Low Threshold Voltage	3.75	—	4.05		
V_{HYST}	5V Detector	—	260	—	mV	(Notes 2, 3)
	Hysteresis Voltage	200	—	300		
$V_{TH(HI)}$	5V Detector High Threshold Voltage	—	4.15	—	V	V_{IN} Rising (Notes 2, 3)
V_{OUT}	LDO Output Voltage	—	3.300	—	V	$I_{OUT} = 20\text{mA}$
		3.234	—	3.366		$4.3\text{V} \leq V_{IN} \leq 5.5\text{V}$, $0\text{mA} \leq I_{OUT} \leq 200\text{mA}$
		3.000	—	—		$3.75\text{V} \leq V_{IN} \leq 4.3\text{V}$, $0\text{mA} \leq I_{OUT} \leq 200\text{mA}$ (Note 4)
I_{OUT}	Output Current	200	—	—	mA	
$REG_{(LINE)}$	Line Regulation	—	0.05	—	%	$V_{IN} = 4.3\text{V}$ to 5.5V
		-0.5	—	0.5		
$REG_{(LOAD)}$	Load Regulation	—	0.05	—	%	$I_{OUT} = 0.1\text{mA}$ to 200mA
		-0.5	—	0.5		

- Note**
- 1: Ensured by design.
 - 2: See 5V Detect Thresholds, Figure 4-1.
 - 3: Recommended source impedance for 5V supply: $\leq 0.25\Omega$. This will ensure that $I_{OUT} \times R_{SOURCE} < V_{HYST}$, thus avoiding D_R toggling during 5V detect threshold transitions.
 - 4: In Application Circuit, Figure 3-1.
 - 5: See Timing Diagram, Figure 4-2.
 - 6: Ground Current is independent of I_{LOAD} .

TC1266 ELECTRICAL SPECIFICATIONS (CONTINUED)

Electrical Characteristics: $T_A = +25^\circ\text{C}$, $V_{IN} = 5\text{V}$, $V_{AUX} = 3.3\text{V}$, $I_{OUT} = 0.1\text{mA}$, $C_{OUT} = 4.7\mu\text{F}$, unless otherwise noted. Boldface type specifications apply over full operating temperature range.						
Symbol	Parameter	Min	Typ	Max	Units	Test Conditions
V_{DR}	Drive Voltage	$V_{IN} - 0.2$ $V_{IN} - 0.3$	$V_{IN} - 0.1$ —	— —	V	$4.3\text{V} \leq V_{IN} \leq 5.5\text{V}$, $I_{DR} = 200\mu\text{A}$
		— —	35 —	150 200	mV	$V_{IN} < V_{TH(LO)}$, $I_{DR} = 200\mu\text{A}$
$I_{DR(PK)}$	Peak Drive Current	7 6	— —	— —	mA	Sinking: $V_{IN} = 3.75\text{V}$, $V_{DR} = 1\text{V}$; Sourcing: $V_{IN} = 4.3\text{V}$, $V_{IN} - V_{DR} = 2\text{V}$
t_{DH}	Drive High Delay (Notes 1, 5)	— —	4 —	— 8	μsec	$C_{DR} = 1.2\text{nF}$, V_{IN} ramping up, measured from $V_{IN} = V_{TH(HI)}$ to $V_{DR} = 2\text{V}$
t_{DL}	Drive Low Delay (Notes 1, 5)	— —	0.6 —	1.5 3.0	μsec	$C_{DR} = 1.2\text{nF}$, V_{IN} ramping down, measured from $V_{IN} = V_{TH(LO)}$ to $V_{DR} = 2\text{V}$

- Note**
- 1: Ensured by design.
 - 2: See 5V Detect Thresholds, Figure 4-1.
 - 3: Recommended source impedance for 5V supply: $\leq 0.25\Omega$. This will ensure that $I_{OUT} \times R_{SOURCE} < V_{HYST}$, thus avoiding D_R toggling during 5V detect threshold transitions.
 - 4: In Application Circuit, Figure 3-1.
 - 5: See Timing Diagram, Figure 4-2.
 - 6: Ground Current is independent of I_{LOAD} .

TC1266

2.0 PIN DESCRIPTIONS

The descriptions of the pins are listed in Table 2-1.

TABLE 2-1: PIN FUNCTION TABLE

Pin No. (8-Pin SOIC) (8-Pin MSOP)	Symbol	Description
1	V_{IN}	Main input supply for the TC1266, nominally 5V.
2	NC	Not connected.
3	V_{AUX}	Auxiliary input supply, nominally 3.3V.
4	GND	Logic and power ground.
5	NC	Not connected.
6	SENSE	Sense pin for V_{OUT} . Connect to V_{OUT} at the load to minimize voltage drop across PCB traces.
7	V_{OUT}	LDO 3.3V output.
8	D_R	Driver output for external P-channel MOSFET pass element.

3.0 DETAILED DESCRIPTION

FIGURE 3-1: APPLICATION CIRCUIT

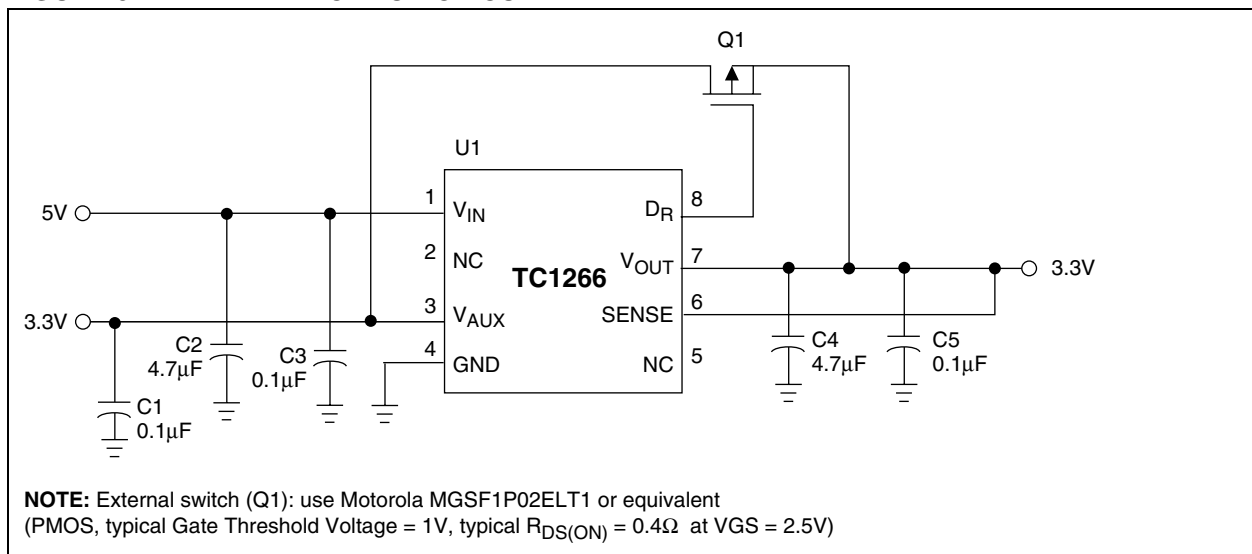

4.0 THERMAL CONSIDERATIONS

4.1 Thermal Shutdown

Integrated thermal protection circuitry shuts the regulator off when die temperature exceeds 160°C. The regulator remains off until the die temperature drops to approximately 150°C.

4.2 Power Dissipation

The amount of power the regulator dissipates is primarily a function of input and output voltage, and output current. The following equation is used to calculate worst case actual power dissipation:

EQUATION 4-1:

$$P_D \approx (V_{INMAX} - V_{OUTMIN})I_{LOADMAX}$$

Where:

- P_D = Worst case actual power dissipation
- V_{INMAX} = Maximum voltage on V_{IN}
- V_{OUTMIN} = Minimum regulator output voltage
- $I_{LOADMAX}$ = Maximum output (load) current

The maximum allowable power dissipation (Equation 4-2) is a function of the maximum ambient temperature (T_{AMAX}), the maximum allowable die temperature (T_{JMAX}) and the thermal resistance from junction-to-air (θ_{JA}).

EQUATION 4-2:

$$P_{DMAX} = \frac{(T_{JMAX} - T_{AMAX})}{\theta_{JA}}$$

Where all terms are previously defined.

Equation 4-1 can be used in conjunction with Equation 4-2 to ensure regulator thermal operation is within limits. For example:

Given:

$$\begin{aligned} V_{INMAX} &= 5V \pm 5\% \\ V_{OUTMIN} &= 3.217V \\ I_{LOADMAX} &= 200mA \\ T_{JMAX} &= 125^\circ C \\ T_{AMAX} &= 70^\circ C \\ \theta_{JA} &= 130^\circ C/W \text{ (SOIC)} \end{aligned}$$

Find: 1. Actual power dissipation
2. Maximum allowable dissipation

Actual power dissipation:

$$\begin{aligned} P_D &\approx (V_{INMAX} - V_{OUTMIN})I_{LOADMAX} \\ &= (5.25V - 3.217V) 200mA \\ &= 407mW \end{aligned}$$

Maximum allowable power dissipation:

$$\begin{aligned} P_{DMAX} &= \frac{(T_{JMAX} - T_{AMAX})}{\theta_{JA}} \\ &= \frac{(125 - 70)}{130} \\ &= 423mW \end{aligned}$$

In this example, the TC1266 dissipates a maximum of 407mW; below the allowable limit of 423mW.

TC1266

FIGURE 4-1: 5V DETECT THRESHOLD

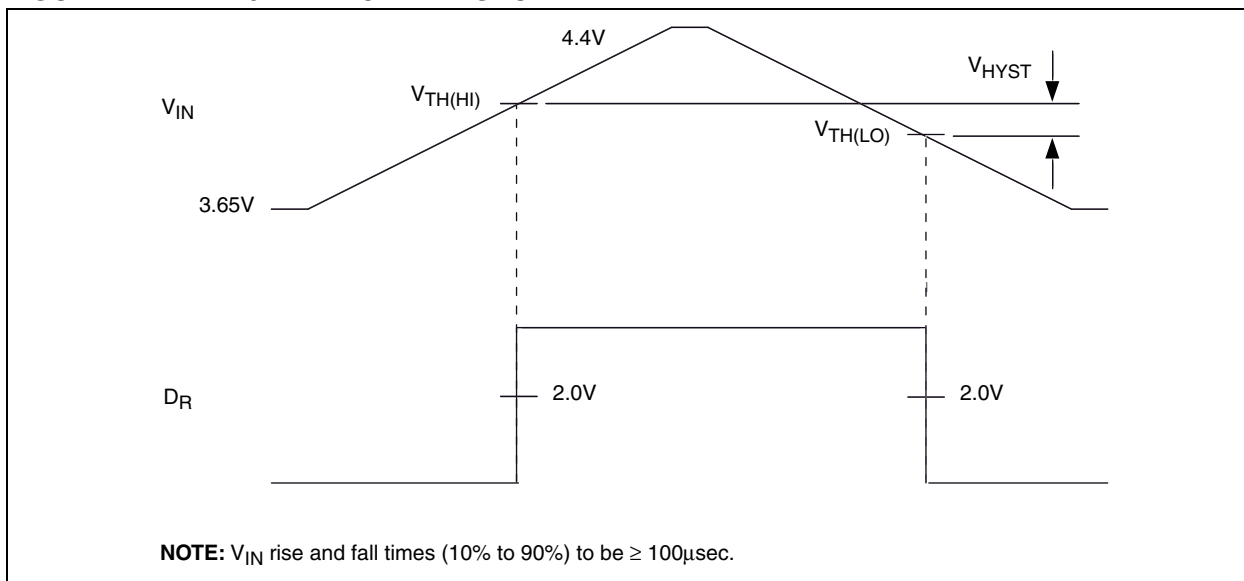
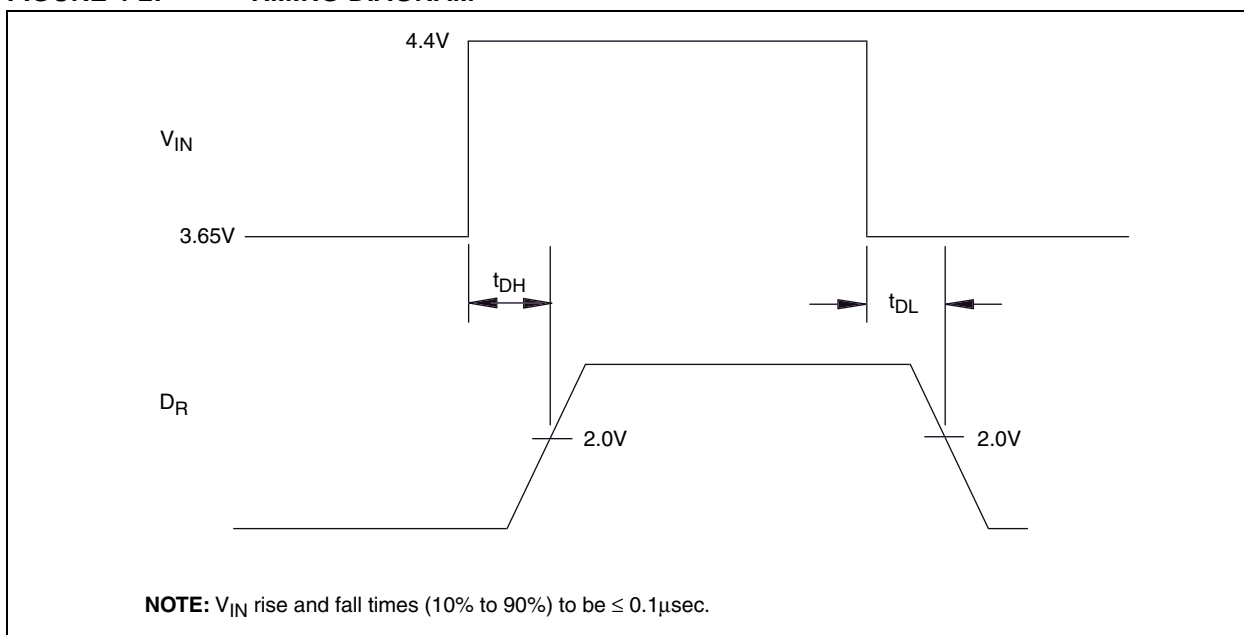
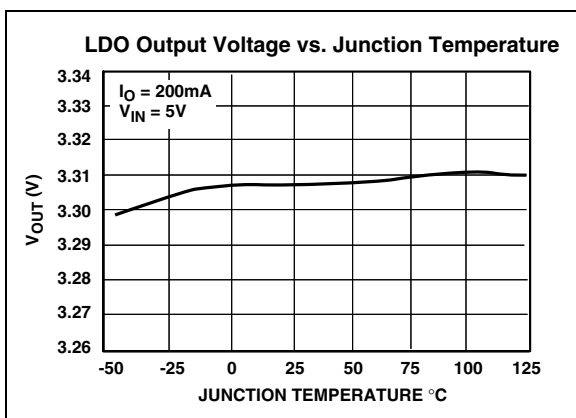
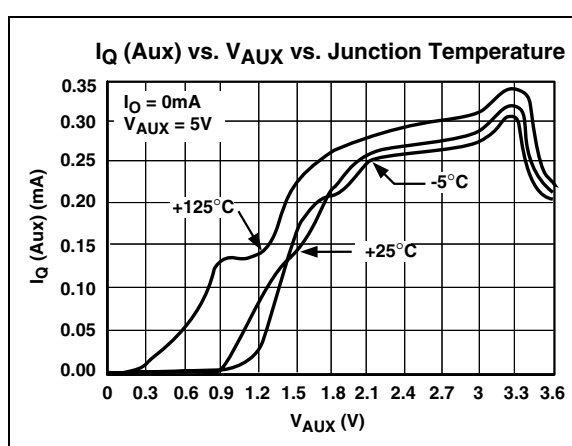
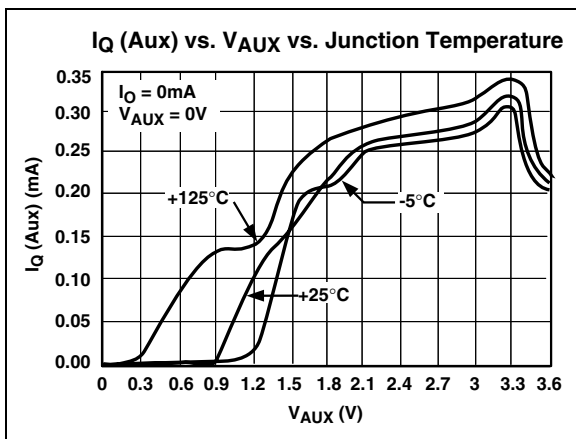
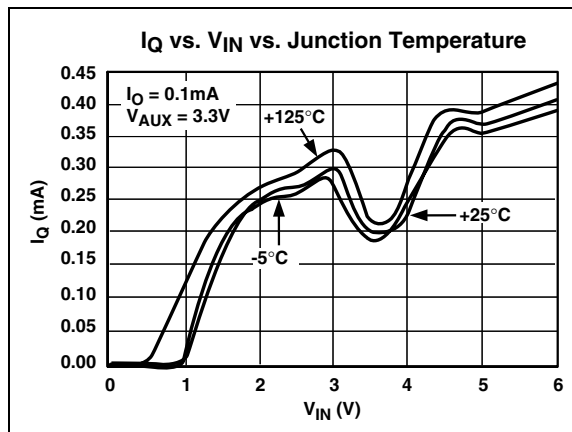
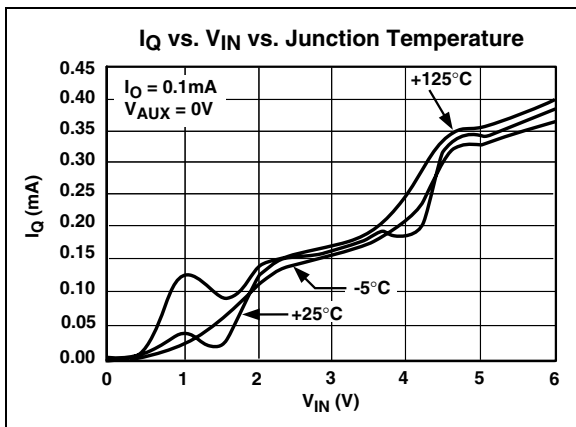

FIGURE 4-2: TIMING DIAGRAM



5.0 TYPICAL CHARACTERISTICS

Note: The graphs and tables provided following this note are a statistical summary based on a limited number of samples and are provided for informational purposes only. The performance characteristics listed herein are not tested or guaranteed. In some graphs or tables, the data presented may be outside the specified operating range (e.g., outside specified power supply range) and therefore outside the warranted range.



TC1266

5.0 TYPICAL CHARACTERISTICS (CONTINUED)

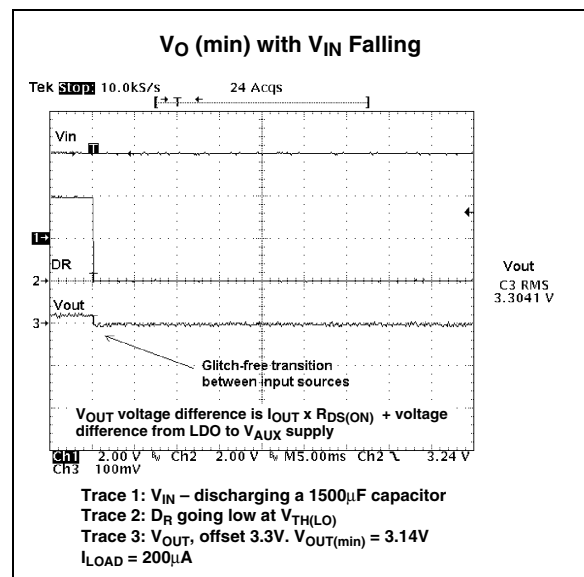
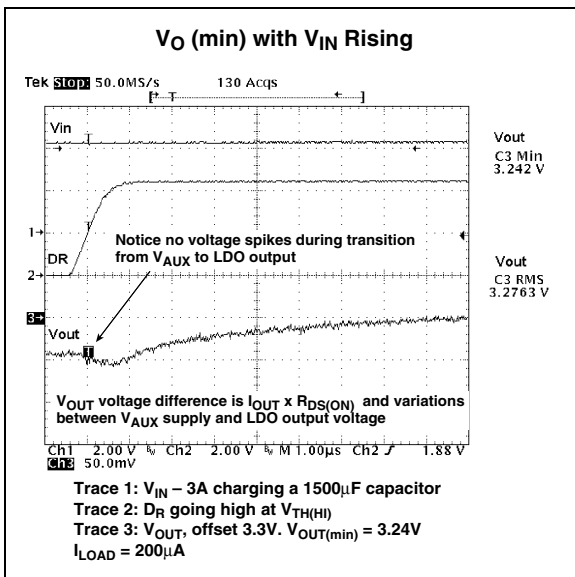
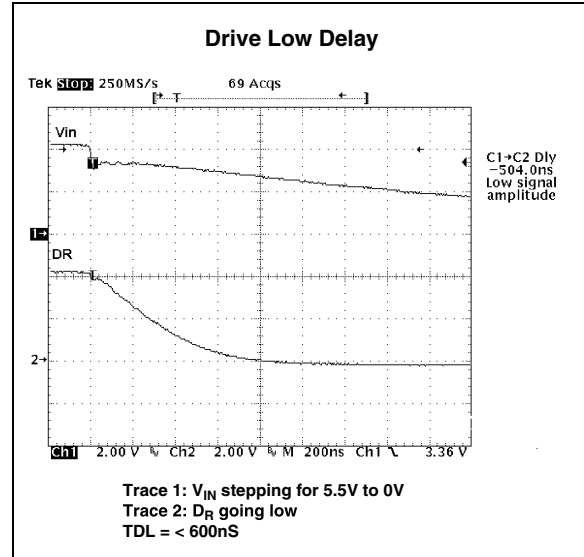
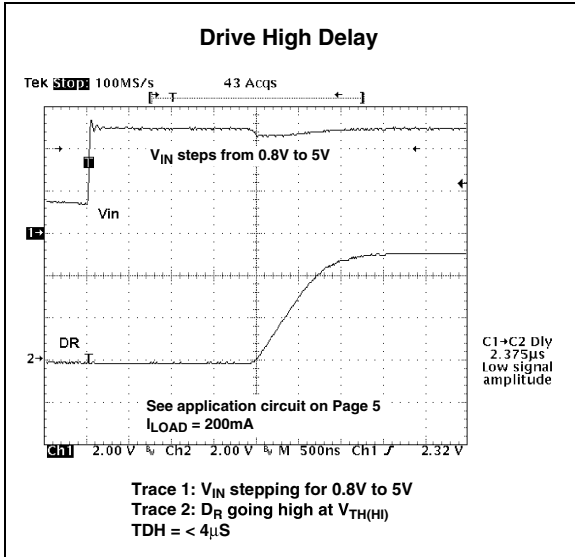

5.0 TYPICAL CHARACTERISTICS (CONTINUED)

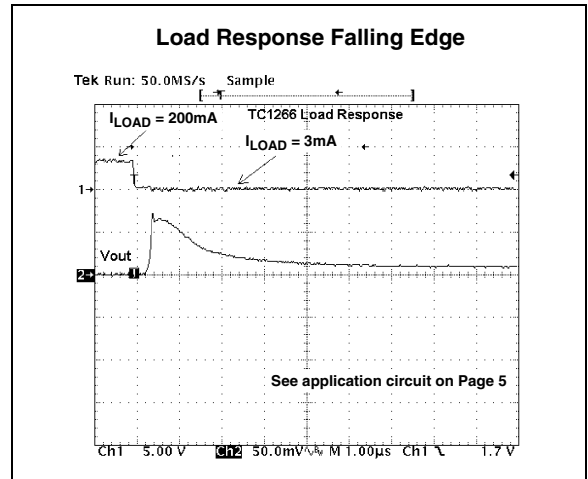
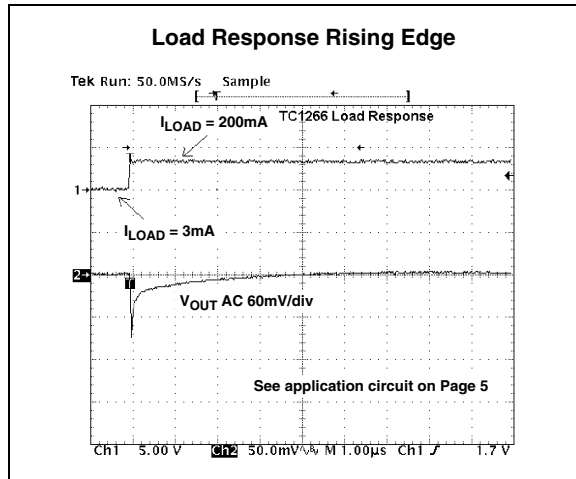

TC1266

6.0 PACKAGING INFORMATION

6.1 Package Marking Information

Package marking data not available at this time.

6.2 Taping Form

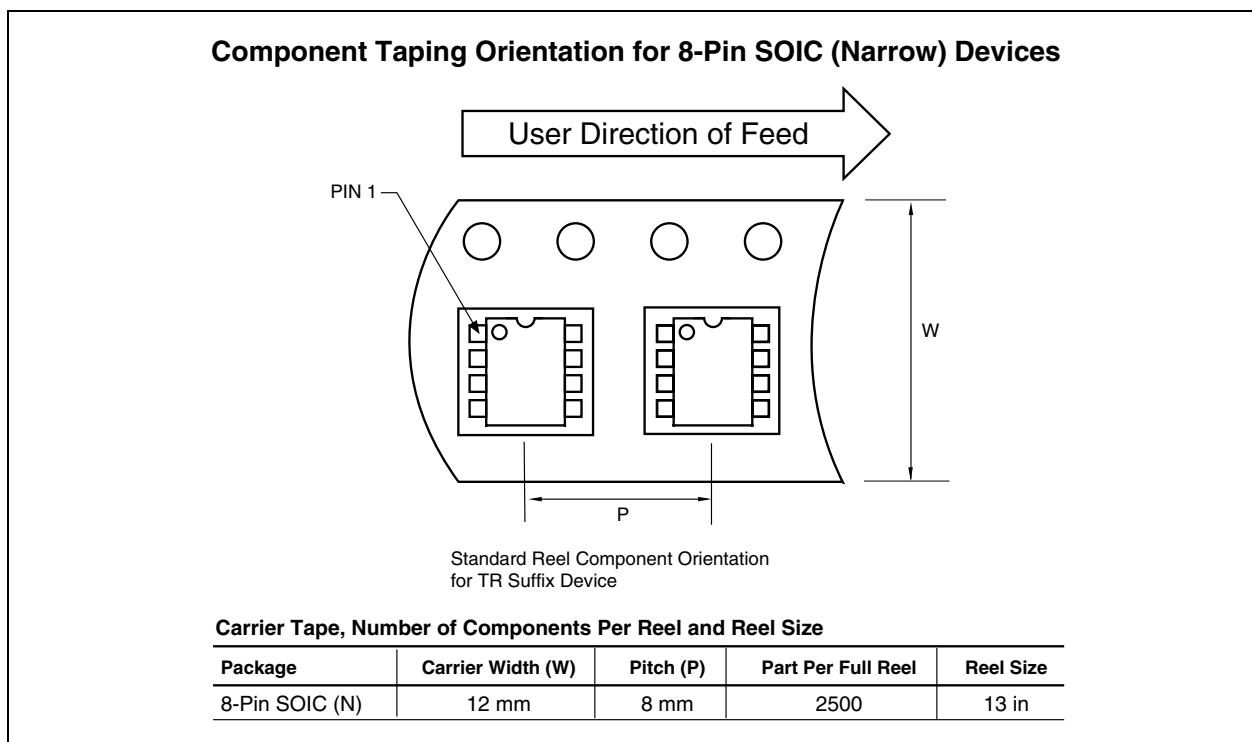
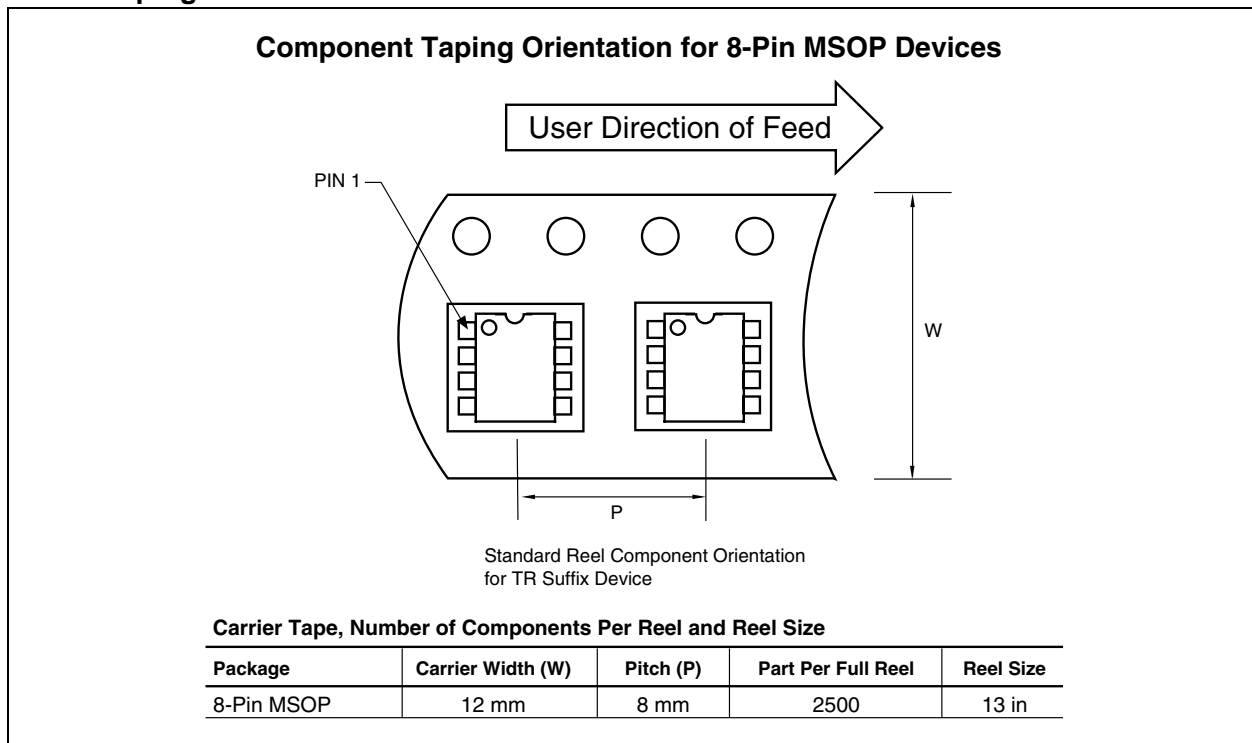

6.3 Package Dimensions

8-Pin MSOP

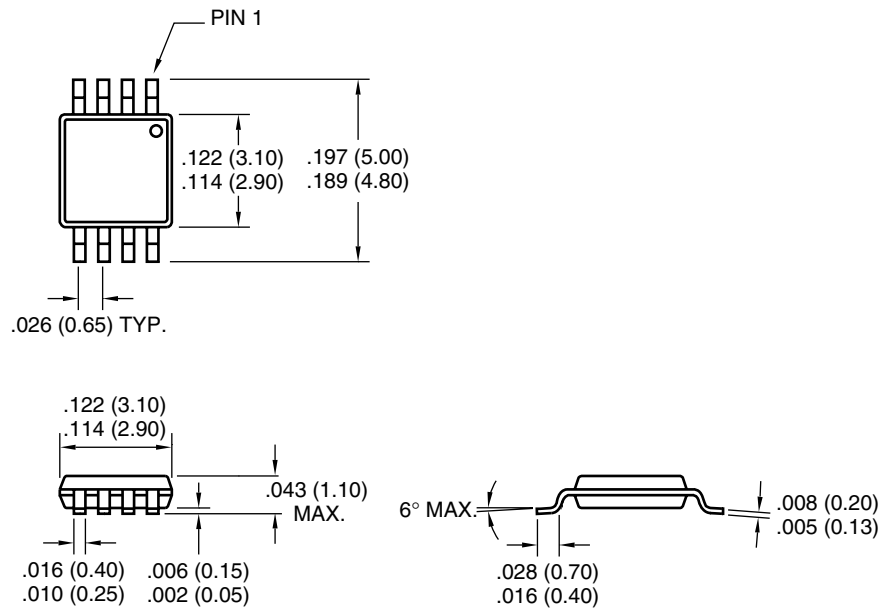

Dimensions: inches (mm)

8-Pin SOIC

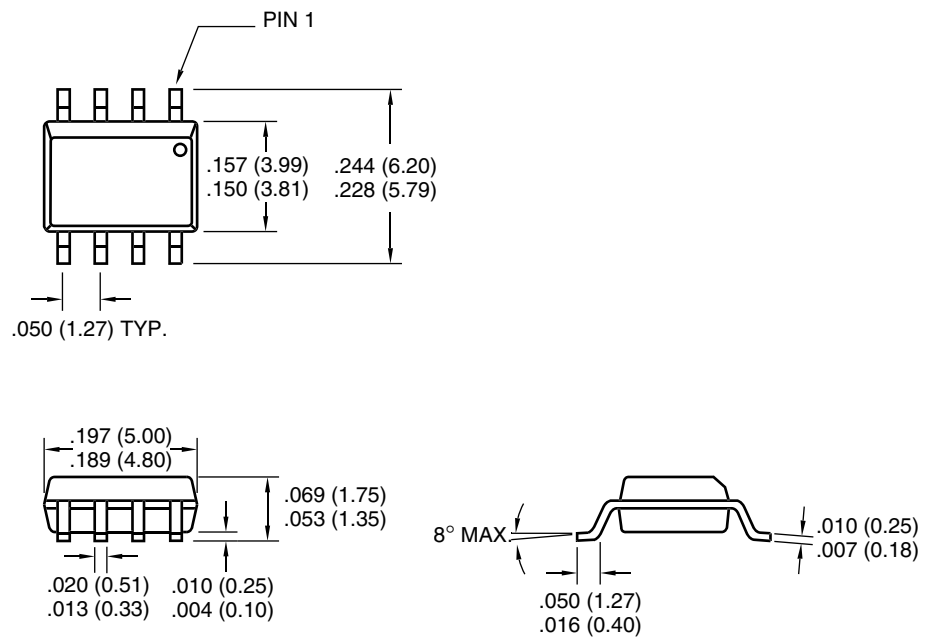

Dimensions: inches (mm)

TC1266

NOTES:

SALES AND SUPPORT

Data Sheets

Products supported by a preliminary Data Sheet may have an errata sheet describing minor operational differences and recommended workarounds. To determine if an errata sheet exists for a particular device, please contact one of the following:

1. Your local Microchip sales office
2. The Microchip Corporate Literature Center U.S. FAX: (480) 792-7277
3. The Microchip Worldwide Site (www.microchip.com)

Please specify which device, revision of silicon and Data Sheet (include Literature #) you are using.

New Customer Notification System

Register on our web site (www.microchip.com/cn) to receive the most current information on our products.

TC1266

NOTES:

Information contained in this publication regarding device applications and the like is intended through suggestion only and may be superseded by updates. It is your responsibility to ensure that your application meets with your specifications. No representation or warranty is given and no liability is assumed by Microchip Technology Incorporated with respect to the accuracy or use of such information, or infringement of patents or other intellectual property rights arising from such use or otherwise. Use of Microchip's products as critical components in life support systems is not authorized except with express written approval by Microchip. No licenses are conveyed, implicitly or otherwise, under any intellectual property rights.

Trademarks

The Microchip name and logo, the Microchip logo, FilterLab, KEELOQ, microID, MPLAB, PIC, PICmicro, PICMASTER, PICSTART, PRO MATE, SEEVAL and The Embedded Control Solutions Company are registered trademarks of Microchip Technology Incorporated in the U.S.A. and other countries.

dsPIC, ECONOMONITOR, FanSense, FlexROM, fuzzyLAB, In-Circuit Serial Programming, ICSP, ICEPIC, microPort, Migratable Memory, MPASM, MPLIB, MPLINK, MPSIM, MXDEV, MXLAB, PICC, PICDEM, PICDEM.net, rfPIC, Select Mode and Total Endurance are trademarks of Microchip Technology Incorporated in the U.S.A.

Serialized Quick Turn Programming (SQTP) is a service mark of Microchip Technology Incorporated in the U.S.A.

All other trademarks mentioned herein are property of their respective companies.

© 2002, Microchip Technology Incorporated, Printed in the U.S.A., All Rights Reserved.

 Printed on recycled paper.

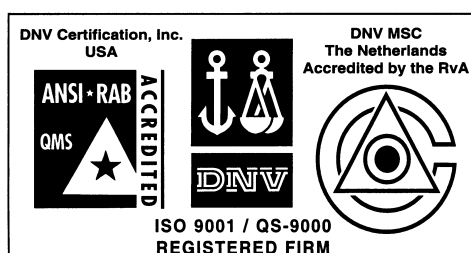

Microchip received QS-9000 quality system certification for its worldwide headquarters, design and wafer fabrication facilities in Chandler and Tempe, Arizona in July 1999 and Mountain View, California in March 2002. The Company's quality system processes and procedures are QS-9000 compliant for its PICmicro® 8-bit MCUs, KEELOQ® code hopping devices, Serial EEPROMs, microperipherals, non-volatile memory and analog products. In addition, Microchip's quality system for the design and manufacture of development systems is ISO 9001 certified.



WORLDWIDE SALES AND SERVICE

AMERICAS

Corporate Office

2355 West Chandler Blvd.
Chandler, AZ 85224-6199
Tel: 480-792-7200 Fax: 480-792-7277
Technical Support: 480-792-7627
Web Address: <http://www.microchip.com>

Rocky Mountain

2355 West Chandler Blvd.
Chandler, AZ 85224-6199
Tel: 480-792-7966 Fax: 480-792-7456

Atlanta

500 Sugar Mill Road, Suite 200B
Atlanta, GA 30350
Tel: 770-640-0034 Fax: 770-640-0307

Boston

2 Lan Drive, Suite 120
Westford, MA 01886
Tel: 978-692-3848 Fax: 978-692-3821

Chicago

333 Pierce Road, Suite 180
Itasca, IL 60143
Tel: 630-285-0071 Fax: 630-285-0075

Dallas

4570 Westgrove Drive, Suite 160
Addison, TX 75001
Tel: 972-818-7423 Fax: 972-818-2924

Detroit

Tri-Atria Office Building
32255 Northwestern Highway, Suite 190
Farmington Hills, MI 48334
Tel: 248-538-2250 Fax: 248-538-2260

Kokomo

2767 S. Albright Road
Kokomo, Indiana 46902
Tel: 765-864-8360 Fax: 765-864-8387

Los Angeles

18201 Von Karman, Suite 1090
Irvine, CA 92612
Tel: 949-263-1888 Fax: 949-263-1338

New York

150 Motor Parkway, Suite 202
Hauppauge, NY 11788
Tel: 631-273-5305 Fax: 631-273-5335

San Jose

Microchip Technology Inc.
2107 North First Street, Suite 590
San Jose, CA 95131
Tel: 408-436-7950 Fax: 408-436-7955

Toronto

6285 Northam Drive, Suite 108
Mississauga, Ontario L4V 1X5, Canada
Tel: 905-673-0699 Fax: 905-673-6509

ASIA/PACIFIC

Australia

Microchip Technology Australia Pty Ltd
Suite 22, 41 Rawson Street
Epping 2121, NSW
Australia
Tel: 61-2-9868-6733 Fax: 61-2-9868-6755

China - Beijing

Microchip Technology Consulting (Shanghai)
Co., Ltd., Beijing Liaison Office
Unit 915
Bei Hai Wan Tai Bldg.
No. 6 Chaoyangmen Beidajie
Beijing, 100027, No. China
Tel: 86-10-85282100 Fax: 86-10-85282104

China - Chengdu

Microchip Technology Consulting (Shanghai)
Co., Ltd., Chengdu Liaison Office
Rm. 2401, 24th Floor,
Ming Xing Financial Tower
No. 88 TIDU Street
Chengdu 610016, China
Tel: 86-28-86766200 Fax: 86-28-86766599

China - Fuzhou

Microchip Technology Consulting (Shanghai)
Co., Ltd., Fuzhou Liaison Office
Unit 28F, World Trade Plaza
No. 71 Wusi Road
Fuzhou 350001, China
Tel: 86-591-7503506 Fax: 86-591-7503521

China - Shanghai

Microchip Technology Consulting (Shanghai)
Co., Ltd.
Room 701, Bldg. B
Far East International Plaza
No. 317 Xian Xia Road
Shanghai, 200051
Tel: 86-21-6275-5700 Fax: 86-21-6275-5060

China - Shenzhen

Microchip Technology Consulting (Shanghai)
Co., Ltd., Shenzhen Liaison Office
Rm. 1315, 13/F, Shenzhen Kerry Centre,
Renminnan Lu
Shenzhen 518001, China
Tel: 86-755-2350361 Fax: 86-755-2366086

China - Hong Kong SAR

Microchip Technology Hongkong Ltd.
Unit 901-6, Tower 2, Metroplaza
223 Hing Fong Road
Kwai Fong, N.T., Hong Kong
Tel: 852-2401-1200 Fax: 852-2401-3431

India

Microchip Technology Inc.
India Liaison Office
Divyasree Chambers
1 Floor, Wing A (A3/A4)
No. 11, O'Shaughnessy Road
Bangalore, 560 025, India
Tel: 91-80-2290061 Fax: 91-80-2290062

Japan

Microchip Technology Japan K.K.
Benex S-1 6F
3-18-20, Shinyokohama
Kohoku-Ku, Yokohama-shi
Kanagawa, 222-0033, Japan
Tel: 81-45-471-6166 Fax: 81-45-471-6122

Korea

Microchip Technology Korea
168-1, Youngbo Bldg. 3 Floor
Samsung-Dong, Kangnam-Ku
Seoul, Korea 135-882
Tel: 82-2-554-7200 Fax: 82-2-558-5934

Singapore

Microchip Technology Singapore Pte Ltd.
200 Middle Road
#07-02 Prime Centre
Singapore, 188980
Tel: 65-6334-8870 Fax: 65-6334-8850

Taiwan

Microchip Technology Taiwan
11F-3, No. 207
Tung Hua North Road
Taipei, 105, Taiwan
Tel: 886-2-2717-7175 Fax: 886-2-2545-0139

EUROPE

Denmark

Microchip Technology Nordic ApS
Regus Business Centre
Lautrup hof 1-3
Ballerup DK-2750 Denmark
Tel: 45 4420 9895 Fax: 45 4420 9910

France

Microchip Technology SARL
Parc d'Activite du Moulin de Massy
43 Rue du Saule Trapu
Batiment A - 1er Etage
91300 Massy, France
Tel: 33-1-69-53-63-20 Fax: 33-1-69-30-90-79

Germany

Microchip Technology GmbH
Gustav-Heinemann Ring 125
D-81739 Munich, Germany
Tel: 49-89-627-144 0 Fax: 49-89-627-144-44

Italy

Microchip Technology SRL
Centro Direzionale Colleoni
Palazzo Taurus 1 V. Le Colleoni 1
20041 Agrate Brianza
Milan, Italy
Tel: 39-039-65791-1 Fax: 39-039-6899883

United Kingdom

Microchip Ltd.
505 Eskdale Road
Winnersh Triangle
Wokingham
Berkshire, England RG41 5TU
Tel: 44 118 921 5869 Fax: 44-118 921-5820

05/01/02

