

150mA Regulator

Monolithic IC MM157□□N, 161□□N

Outline

This IC is an ultra-small, low noise, stable power supply that supports ceramic capacitors (low ESR) Output current goes up to 150mA, and use of a noise pin reduces output noise even further. Output ON/OFF can be controlled with the ON/OFF pin.

Features

- | | |
|--|---------------------------------------|
| 1. I/O voltage difference | 0.10V typ. (I _o =50mA) |
| 2. Output noise voltage | 30μVrms typ. (C _n =0.01μF) |
| 3. Recommended maximum output current | 150mA max. |
| 4. No-load current consumption | 85μA typ. |
| 5. Built-in overcurrent protection and thermal shutdown circuits | |
| 6. Output voltage rank | 1.8 ~ 5.0V (0.1V steps) |
| 7. Output ON/OFF control function | High: ON, Low: OFF |

Package

SOT-25A (MM157□□N, MM161□□N)
 * □□ contains the output voltage rank.

Applications

1. Cordless telephone
2. Cellular telephone, PHS
3. Portable MD
4. Other battery-powered portable equipment

Pin Assignment

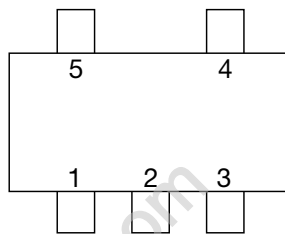

SOT-25A
(TOP VIEW)

MM157□□N

1	V _{IN}
2	GND
3	Cont
4	Noise
5	V _O

MM161□□N

1	Cont
2	GND
3	Noise
4	V _{OUT}
5	V _{IN}

*The component MM161□□N is MM157□□N with changed pin configuration.

Equivalent Circuit Diagram

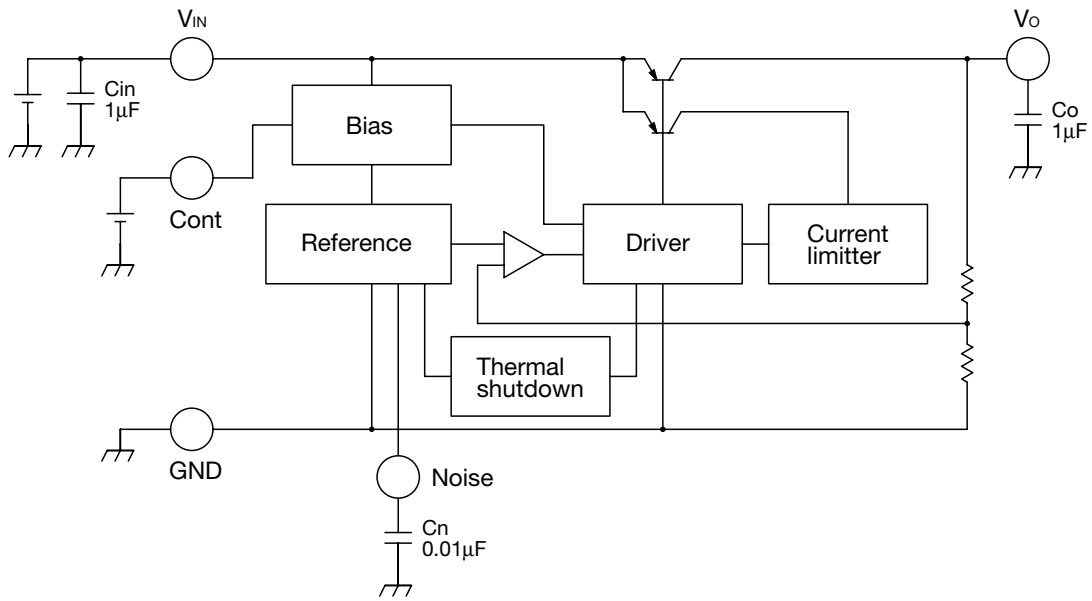

Pin Description Typical model: MM157□□N

Pin No.	Pin name	Function	Internal equivalent circuit diagram						
1	V _{IN}	Input pin The capacitor is required to connect with input pin more than 1µF.							
2	GND	Ground							
3	Cont	ON/OFF Control pin <table border="1" style="margin-left: 20px;"> <tr> <td>Cont</td> <td>V_O</td> </tr> <tr> <td>H</td> <td>ON</td> </tr> <tr> <td>L</td> <td>OFF</td> </tr> </table> <p>Cont pin must be connected with V_{IN} pin, if it is not used.</p>	Cont	V _O	H	ON	L	OFF	
Cont	V _O								
H	ON								
L	OFF								

Pin No.	Pin name	Function	Internal equivalent circuit diagram
4	Noise	Noise decrease pin Connecting 0.01μF capacitor can decrease output noise. If the noise decrease capacitor is not connected, the pin may be influenced by outside noise.	
5	V _o	Output pin The capacitor must be connected with output pin more than 1μF.	

Absolute Maximum Ratings (T_a=25°C)

Item	Symbol	Ratings	Units
Storage temperature	T _{STG}	-40~+150	°C
Operating temperature	T _{OPR}	-30~+85	°C
Supply voltage	V _{IN}	-0.3~+12	V
Allowable loss	P _d	150 (Not attached)	mW

Recommended Operating Conditions

Item	Symbol	Ratings	Units
Output current	I _{OUT}	0~150	mA
Operating voltage	V _{OP}	V _{OUT} Typ. +0.5~+12	V

Electrical Characteristics 1 (Except where noted otherwise, Ta=25°C, VIN=Vo Typ. +1V, Io=1mA, VCONT=2V)

Item	Symbol	Measurement conditions	Min.	Typ.	Max.	Units
No-Load input current	ICC	Io=0mA		85	130	μA
Input current (OFF)	ICCOFF	VCONT=0V		0	0.1	μA
Output voltage	VOUT		×0.98		×1.02	V
Dropout voltage *2	Vio	VIN=Vo-0.2V, Io=50mA		0.1	0.2	V
Line regulation	ΔV1	VIN=Vo Typ. +1~10V		10	20	mV
Load regulation	ΔV2	Io=1~150mA		30	90	mV
VOUT temperature coefficient *1	ΔVOUT/ΔT	Tj=-30~+85°C		100		ppm/°C
Ripple rejection 1 *1	RR1	f=120Hz VRIIPPLE=1V	50	70		dB
Ripple rejection 2 *1	RR2	f=1kHz, Cn=0.01μF VRIIPPLE=1V		60		dB
Output noise voltage *1	Vn	fBW=20~80kHz Cn=0.01μFC		30		μVrms
Cont pin input current	ICONT	VCONT=5V		5	15	μA
Cont pin high threshold level	VCONTH		1.6		VIN+0.3	V
Cont pin low threshold level	VCONTL		-0.3		0.4	V

*1. The parameter is guaranteed by design.

*2. The parameter is not guaranteed in the model less than VOUT=2V

Electrical Characteristics 2 Typical model: MM157□□N

Output Voltage

Product name	Test condisions	Output voltage			Product name	Test condisions	Output voltage		
		Min.	Typ.	Max.			Min.	Typ.	Max.
MM1571J	Io=1mA	1.764	1.8	1.836	MM1574A	Io=1mA	3.920	4.0	4.080
MM1571K		1.862	1.9	1.938	MM1574B		4.018	4.1	4.182
MM1572A		1.960	2.0	2.040	MM1574C		4.116	4.2	4.284
MM1572B		2.058	2.1	2.142	MM1574D		4.214	4.3	4.386
MM1572C		2.156	2.2	2.244	MM1574E		4.312	4.4	4.488
MM1572D		2.254	2.3	2.346	MM1574F		4.410	4.5	4.590
MM1572E		2.352	2.4	2.448	MM1574G		4.508	4.6	4.692
MM1572F		2.450	2.5	2.550	MM1574H		4.606	4.7	4.794
MM1572G		2.548	2.6	2.652	MM1574J		4.704	4.8	4.896
MM1572H		2.646	2.7	2.754	MM1574K		4.802	4.9	4.998
MM1572J		2.744	2.8	2.856	MM1575A		4.900	5.0	5.100
MM1572K		2.842	2.9	2.958					
MM1573A		2.940	3.0	3.060					
MM1573B		3.038	3.1	3.162					
MM1573C		3.136	3.2	3.264					
MM1573D		3.234	3.3	3.366					
MM1573E		3.332	3.4	3.468					
MM1573F		3.430	3.5	3.570					
MM1573G		3.528	3.6	3.672					
MM1573H		3.626	3.7	3.774					
MM1573J		3.724	3.8	3.876					
MM1573K		3.822	3.9	3.978					

* Rank is indicated inside □□ for MM161□□N.
 Example: MM1613N is 3.9V typ.

Measuring Circuit Typical model: MM157□□N

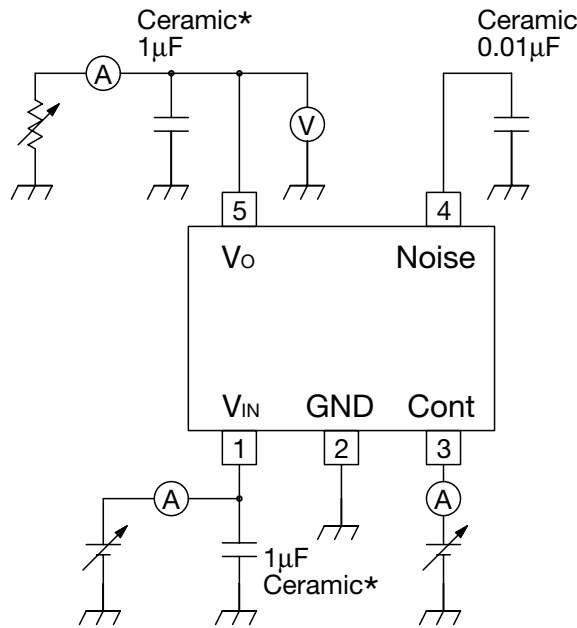

Application Circuit Typical model: MM157□□N

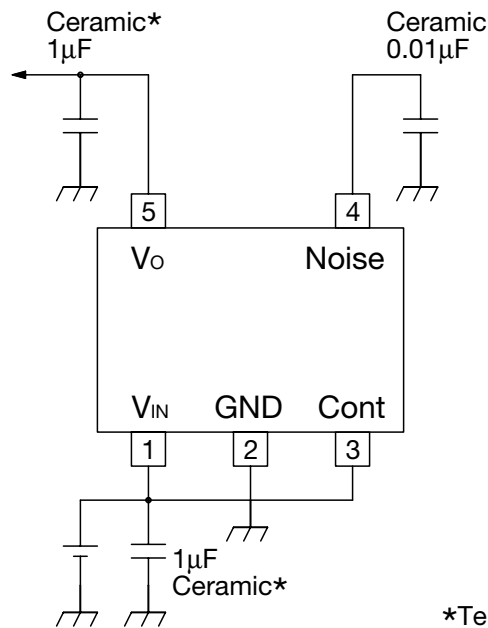

*Temperature Characteristics: B Type

Note

1. The output capacitor is required between output and GND to prevent oscillation.
2. Use a capacitance that is within the ESR characteristics stable range for output capacity.
It is possible to use a ceramic capacitor without ESR resistance for output.
The ceramic capacitor must be used more than 1µF and B type temperature characteristics.
3. The wire of Vcc and GND is required to print full ground plane for noise and stability.
4. The input capacitor must be connected a distance of less than 1cm from input pin.

Characteristics (2.8V product Except where noted therwise, $T_a=25^{\circ}\text{C}$, $V_{IN}=V_o+1\text{V}$, $V_{\text{CONT}}=2\text{V}$, $C_{IN}=1\mu\text{F}$, $C_o=1\mu\text{F}$, $C_n=0.01\mu\text{F}$)

Output-Input Voltage

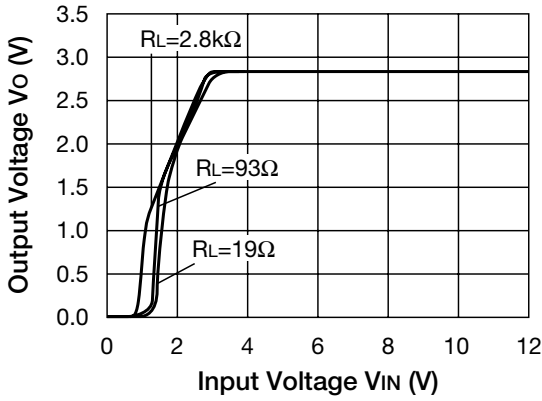

Input Current-Input Voltage

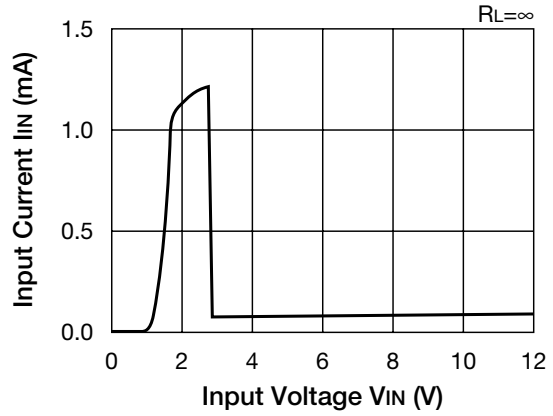

Load Regulation

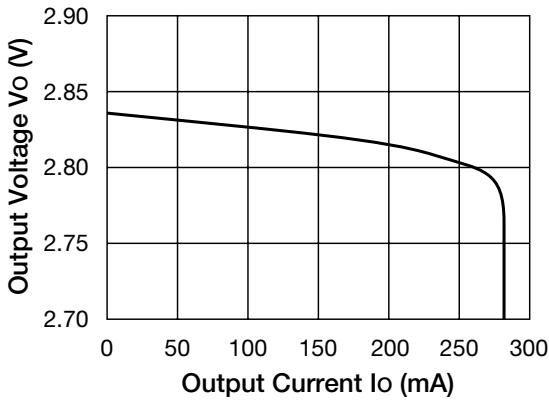

Line Regulation

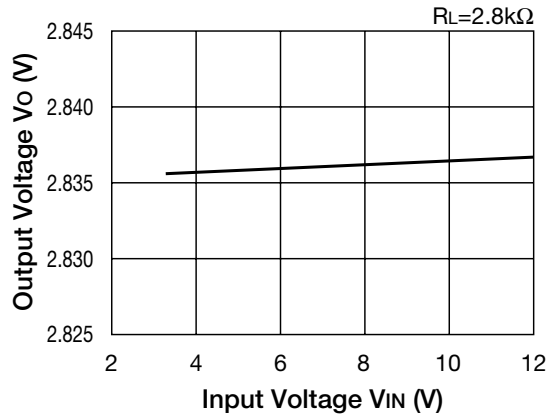

Dropout Voltage-Output Current

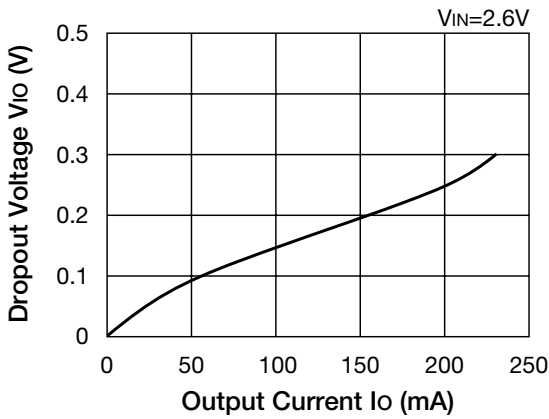

Output Voltage- Ambient Temperature

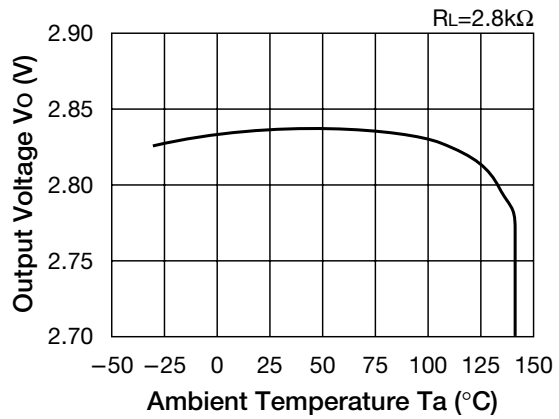

■ Ripple Rejection

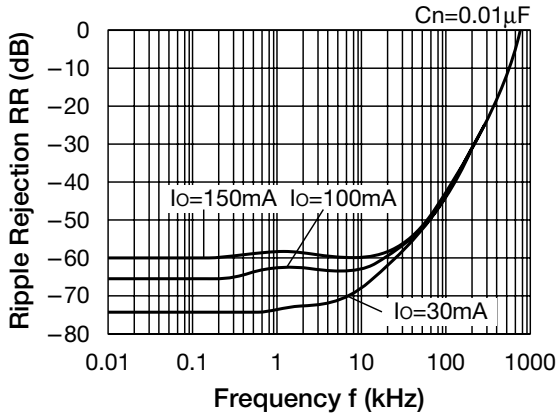

■ Ripple Rejection

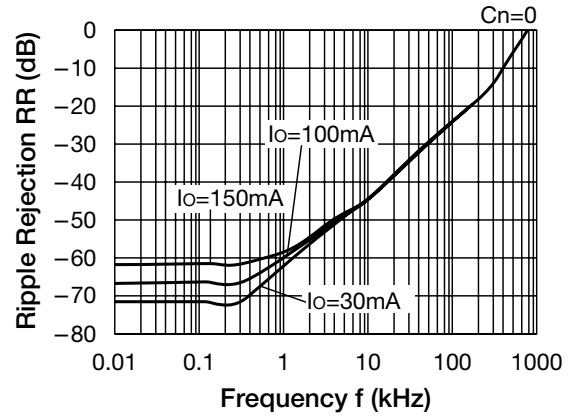

■ GND Pin Current

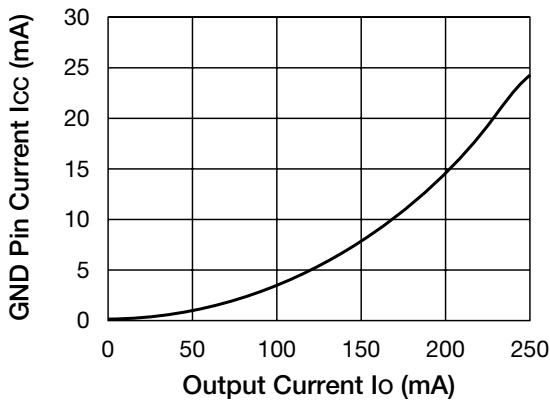

■ Output Noise Voltage

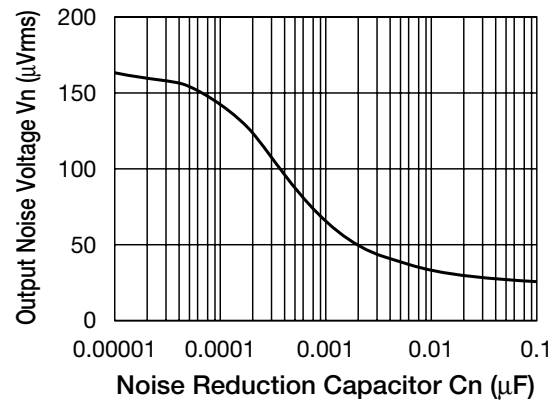

■ ESR Stability Area

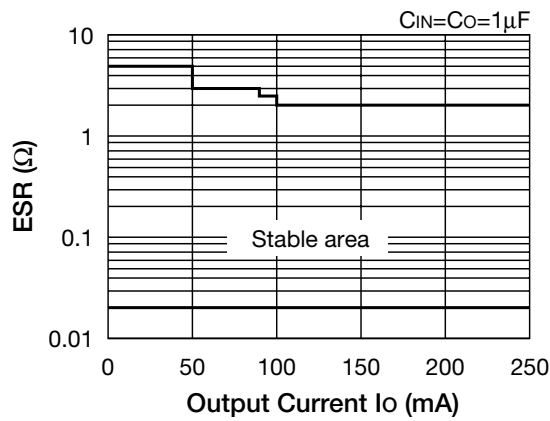

■ ESR Stability Area

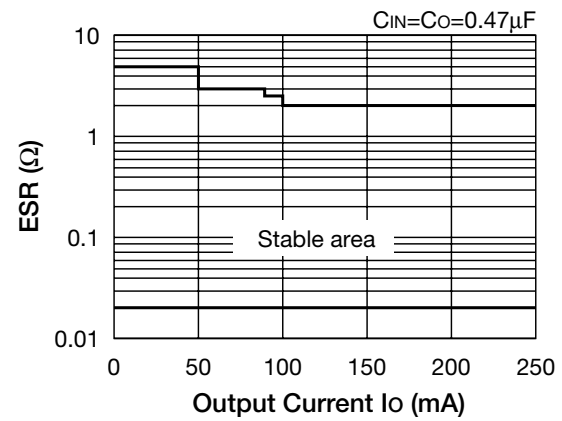

■ Load Transient Responses ($I_o=0 \rightarrow 100\text{mA}$)

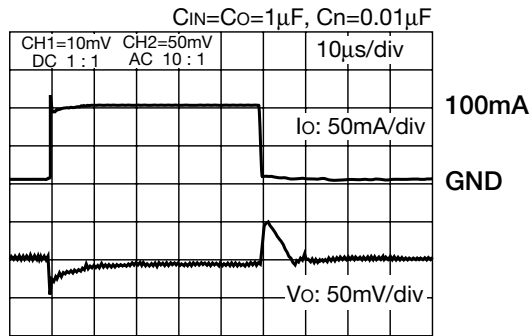

■ Load Transient Responses ($I_o=0 \rightarrow 100\text{mA}$)

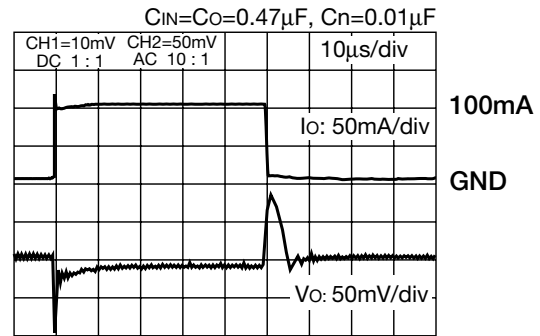

■ Line Transient Responses ($V_{IN}=3.8 \rightarrow 4.8\text{V}, I_o=30\text{mA}$)

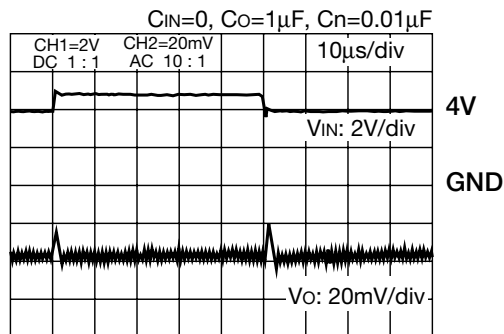

■ Line Transient Responses ($V_{IN}=3.8 \rightarrow 4.8\text{V}, I_o=30\text{mA}$)

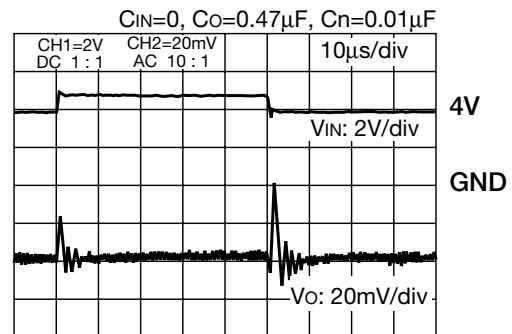

■ Turn-On Transient Responses

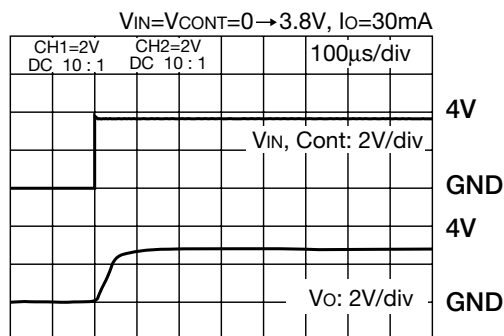

■ Turn-On Transient Responses

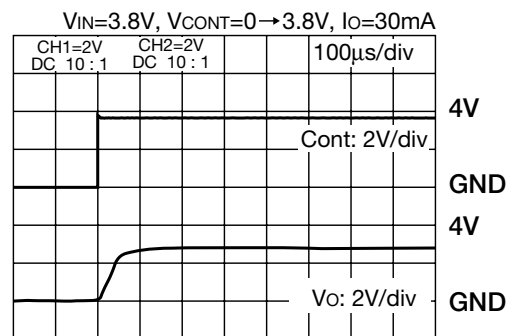

Characteristics (1.8V product Except where noted otherwise, $T_a=25^\circ\text{C}$, $V_{IN}=V_O+1\text{V}$, $V_{CONT}=2\text{V}$, $C_{IN}=1\mu\text{F}$, $C_O=1\mu\text{F}$, $C_n=0.01\mu\text{F}$)

Output-Input Voltage

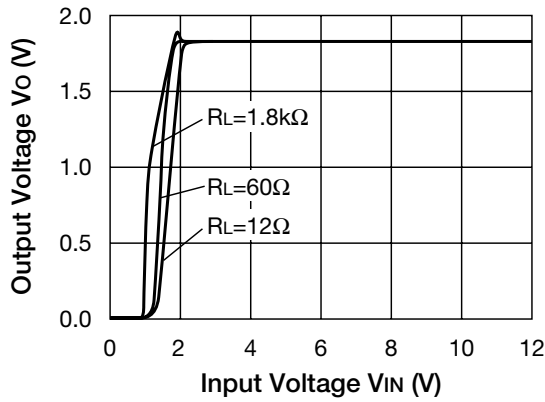

Load Regulation

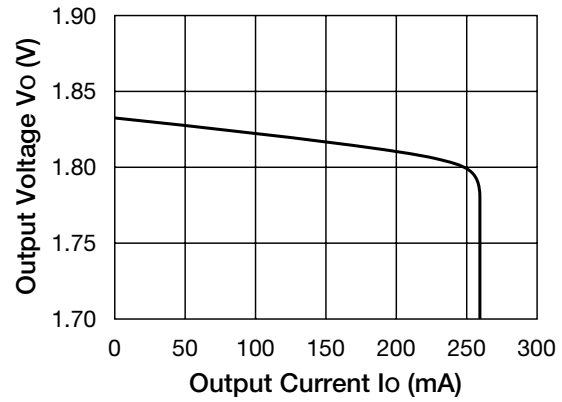

Line Regulation

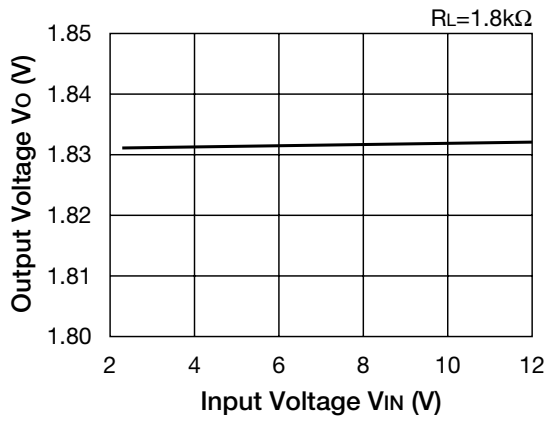

Output Voltage- Ambient Temperature

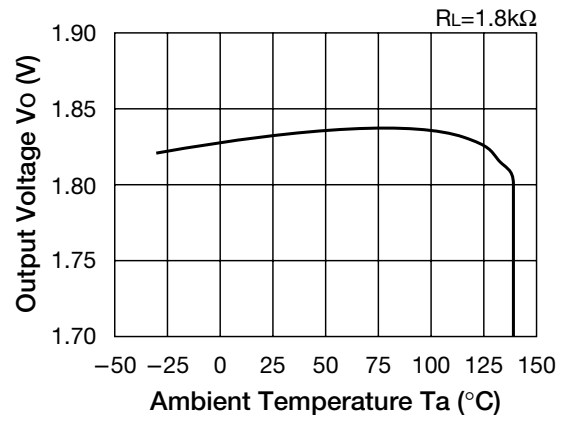

ESR Stability Area

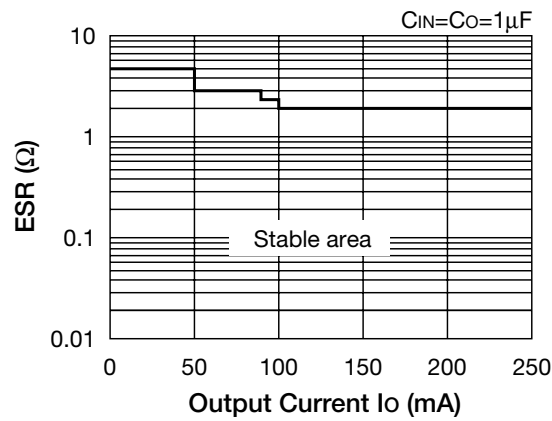

ESR Stability Area

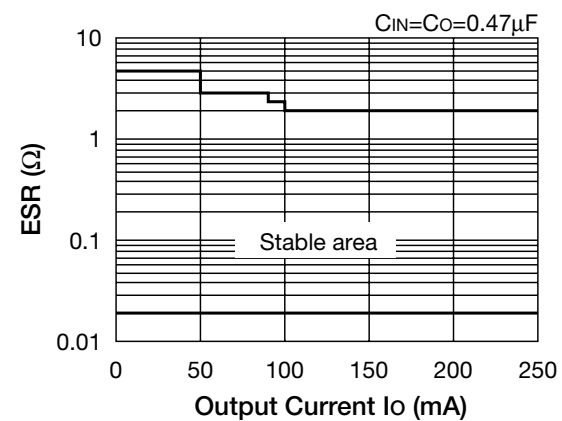

Characteristics (3.5V product Except where noted otherwise, $T_a=25^\circ\text{C}$, $V_{IN}=V_O+1\text{V}$, $V_{\text{CONT}}=2\text{V}$, $C_{IN}=1\mu\text{F}$, $C_O=1\mu\text{F}$, $C_n=0.01\mu\text{F}$)

Output-Input Voltage

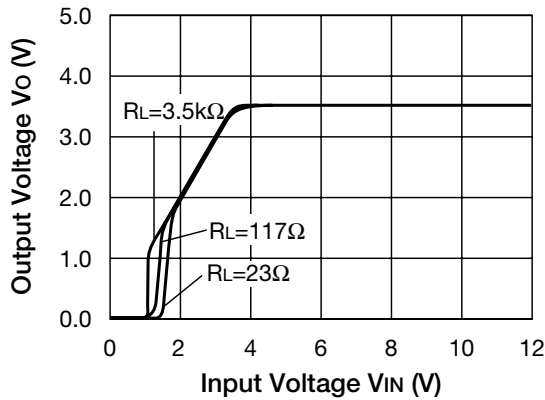

Load Regulation

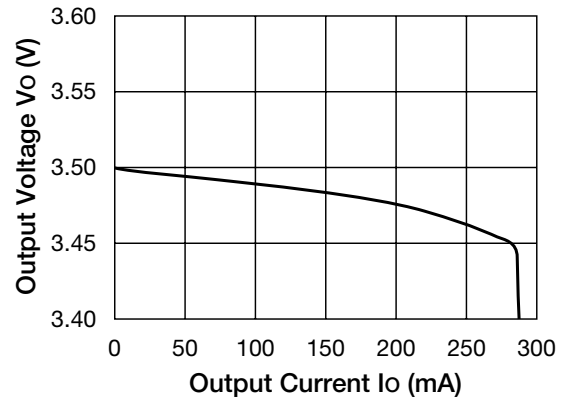

Line Regulation

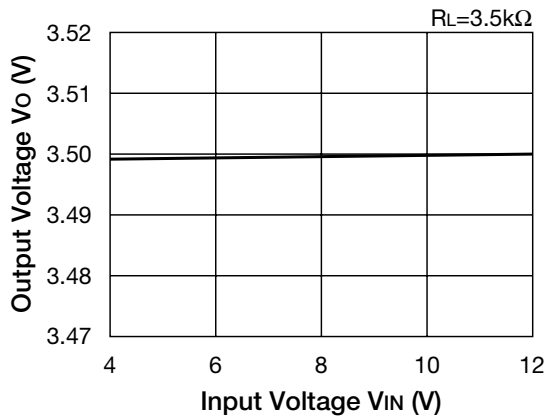

Output Voltage- Ambient Temperature

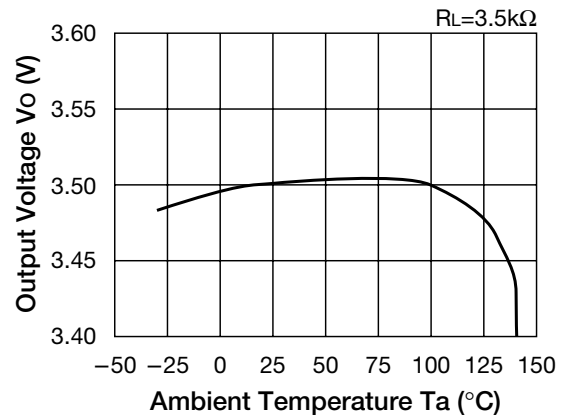

ESR Stability Area

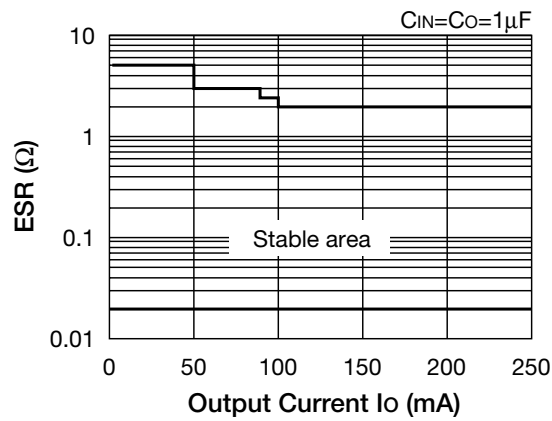

ESR Stability Area

