

**NPN Silicon AF Transistors**

- For AF input stages and driver applications
- High current gain
- Low collector-emitter saturation voltage
- Low noise between 30 Hz and 15 kHz
- Complementary types: BC 856W, BC 857W, BC 858W  
BC 959W, BC 860W (PNP)

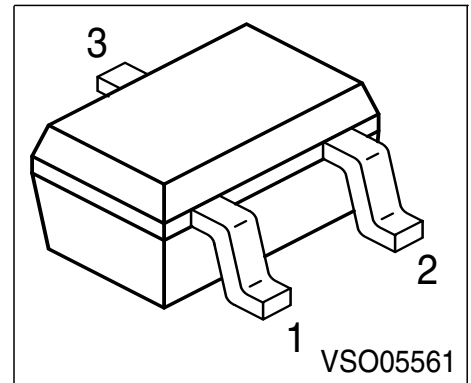

Type	Marking	Pin Configuration			Package
BC 846AW	1As	1 = B	2 = E	3 = C	SOT-323
BC 846BW	1Bs	1 = B	2 = E	3 = C	SOT-323
BC 847AW	1Es	1 = B	2 = E	3 = C	SOT-323
BC 847BW	1Fs	1 = B	2 = E	3 = C	SOT-323
BC 847CW	1Gs	1 = B	2 = E	3 = C	SOT-323
BC 848AW	1Js	1 = B	2 = E	3 = C	SOT-323
BC 848BW	1Ks	1 = B	2 = E	3 = C	SOT-323
BC 848CW	1Ls	1 = B	2 = E	3 = C	SOT-323
BC 849BW	2Bs	1 = B	2 = E	3 = C	SOT-323
BC 849CW	2Cs	1 = B	2 = E	3 = C	SOT-323
BC 850BW	2Fs	1 = B	2 = E	3 = C	SOT-323
BC 850CW	4Gs	1 = B	2 = E	3 = C	SOT-323

**Maximum Ratings**

Parameter	Symbol	BC 846W	BC 847W	BC 848W	Unit
			BC 850W	BC 849W	
Collector-emitter voltage	$V_{CEO}$	65	45	30	V
Collector-base voltage	$V_{CBO}$	80	50	30	
Collector-emitter voltage	$V_{CES}$	80	50	30	V
Emitter-base voltage	$V_{EBO}$	6	6	5	V
DC collector current	$I_C$	100			mA
Peak collector current	$I_{CM}$	200			mA
Peak base current	$I_{BM}$	200			
Peak emitter current	$I_{EM}$	200			
Total power dissipation, $T_S = 124\text{ °C}$	$P_{tot}$	250			mW
Junction temperature	$T_j$	150			°C
Storage temperature	$T_{stg}$	-65 ... 150			

**Thermal Resistance**

Junction ambient <sup>1)</sup>	$R_{thJA}$	≤240	K/W
Junction - soldering point	$R_{thJS}$	≤105	

**Electrical Characteristics at  $T_A = 25\text{ °C}$ , unless otherwise specified.**

Parameter	Symbol	Values			Unit
		min.	typ.	max.	
<b>DC Characteristics</b>					
Collector-emitter breakdown voltage $I_C = 10\text{ mA}$ , $I_B = 0$	$V_{(BR)CEO}$				V
BC846W		65	-	-	
BC847/850W		45	-	-	
BC848/849W		30	-	-	
Collector-base breakdown voltage $I_C = 10\text{ }\mu\text{A}$ , $I_B = 0$	$V_{(BR)CBO}$				
BC 846W		80	-	-	
BC 847/850W		50	-	-	
BC 848/849W		30	-	-	

1) Package mounted on pcb 40mm x 40mm x 1.5mm / 1cm<sup>2</sup> Cu

**Electrical Characteristics** at  $T_A = 25^\circ\text{C}$ , unless otherwise specified.

Parameter	Symbol	Values			Unit
		min.	typ.	max.	
<b>DC Characteristics</b>					
Collector-emitter breakdown voltage $I_C = 10 \mu\text{A}$ , $V_{BE} = 0$	$V_{(BR)CES}$				V
BC 846W		80	-	-	
BC 847/850W		50	-	-	
BC 848/849W		30	-	-	
Emitter-base breakdown voltage $I_E = 1 \mu\text{A}$ , $I_C = 0$	$V_{(BR)EBO}$				
BC 846/847W		6	-	-	
BC 848-850W		5	-	-	
Collector cutoff current $V_{CB} = 30 \text{ V}$ , $I_E = 0$	$I_{CBO}$	-	-	15	nA
Collector cutoff current $V_{CB} = 30 \text{ V}$ , $I_E = 0$ , $T_A = 150^\circ\text{C}$	$I_{CBO}$	-	-	5	$\mu\text{A}$
DC current gain 1) $I_C = 10 \mu\text{A}$ , $V_{CE} = 5 \text{ V}$	$h_{FE}$				-
$h_{FE}$ -group <b>A</b>		-	140	-	
$h_{FE}$ -group <b>B</b>		-	250	-	
$h_{FE}$ -group <b>C</b>		-	480	-	
DC current gain 1) $I_C = 2 \text{ mA}$ , $V_{CE} = 5 \text{ V}$	$h_{FE}$				
$h_{FE}$ -group <b>A</b>		110	180	220	
$h_{FE}$ -group <b>B</b>		200	290	450	
$h_{FE}$ -group <b>C</b>		420	520	800	
Collector-emitter saturation voltage1) $I_C = 10 \text{ mA}$ , $I_B = 0.5 \text{ mA}$ $I_C = 100 \text{ mA}$ , $I_B = 5 \text{ mA}$	$V_{CEsat}$				mV
$I_C = 10 \text{ mA}$ , $I_B = 0.5 \text{ mA}$		-	90	250	
$I_C = 100 \text{ mA}$ , $I_B = 5 \text{ mA}$		-	200	600	
Base-emitter saturation voltage 1) $I_C = 10 \text{ mA}$ , $I_B = 0.5 \text{ mA}$ $I_C = 100 \text{ mA}$ , $I_B = 5 \text{ mA}$	$V_{BEsat}$				
$I_C = 10 \text{ mA}$ , $I_B = 0.5 \text{ mA}$		-	700	-	
$I_C = 100 \text{ mA}$ , $I_B = 5 \text{ mA}$		-	900	-	
Base-emitter voltage 1) $I_C = 2 \text{ mA}$ , $V_{CE} = 5 \text{ V}$ $I_C = 10 \text{ mA}$ , $V_{CE} = 5 \text{ V}$	$V_{BE(ON)}$				
$I_C = 2 \text{ mA}$ , $V_{CE} = 5 \text{ V}$		580	660	700	
$I_C = 10 \text{ mA}$ , $V_{CE} = 5 \text{ V}$		-	-	770	

 1) Pulse test:  $t \leq 300 \mu\text{s}$ ,  $D = 2\%$

**Electrical Characteristics** at  $T_A = 25\text{ }^\circ\text{C}$ , unless otherwise specified.

Parameter	Symbol	Values			Unit
		min.	typ.	max.	
<b>AC characteristics</b>					
Transition frequency $I_C = 20\text{ mA}$ , $V_{CE} = 5\text{ V}$ , $f = 100\text{ MHz}$	$f_T$	-	250	-	MHz
Collector-base capacitance $V_{CB} = 10\text{ V}$ , $f = 1\text{ MHz}$	$C_{cb}$	-	2	3	pF
Emitter-base capacitance $V_{EB} = 0.5\text{ V}$ , $f = 1\text{ MHz}$	$C_{eb}$	-	10	15	
Short-circuit input impedance $I_C = 2\text{ mA}$ , $V_{CE} = 5\text{ V}$ , $f = 1\text{ kHz}$	$h_{11e}$				k $\Omega$
$h_{FE}\text{-gr. A}$	-	2.7	-		
$h_{FE}\text{-gr. B}$	-	4.5	-		
$h_{FE}\text{-gr. C}$	-	8.7	-		
Open-circuit reverse voltage transf.ratio $I_C = 2\text{ mA}$ , $V_{CE} = 5\text{ V}$ , $f = 1\text{ kHz}$	$h_{12e}$				$10^{-4}$
$h_{FE}\text{-gr. A}$	-	1.5	-		
$h_{FE}\text{-gr. B}$	-	2	-		
$h_{FE}\text{-gr. C}$	-	3	-		
Short-circuit forward current transf.ratio $I_C = 2\text{ mA}$ , $V_{CE} = 5\text{ V}$ , $f = 1\text{ kHz}$	$h_{21e}$				-
$h_{FE}\text{-gr. A}$	-	200	-		
$h_{FE}\text{-gr. B}$	-	330	-		
$h_{FE}\text{-gr. C}$	-	600	-		
Open-circuit output admittance $I_C = 2\text{ mA}$ , $V_{CE} = 5\text{ V}$ , $f = 1\text{ kHz}$	$h_{22e}$				$\mu\text{S}$
$h_{FE}\text{-gr. A}$	-	18	-		
$h_{FE}\text{-gr. B}$	-	30	-		
$h_{FE}\text{-gr. C}$	-	60	-		
Noise figure $I_C = 200\text{ }\mu\text{A}$ , $V_{CE} = 5\text{ V}$ , $R_S = 2\text{ k}\Omega$ , $f = 1\text{ kHz}$ , $\Delta f = 200\text{ Hz}$	$F$	-	-	10	dB
	BC 846W				
	BC 847W BC 848W				
Noise figure $I_C = 200\text{ }\mu\text{A}$ , $V_{CE} = 5\text{ V}$ , $R_S = 2\text{ k}\Omega$ , $f = 1\text{ kHz}$ , $\Delta f = 200\text{ Hz}$	$F$				
	BC 849W	-	1.2	4	
	BC 850W	-	1	4	
Equivalent noise voltage $I_C = 200\text{ }\mu\text{A}$ , $V_{CE} = 5\text{ V}$ , $R_S = 2\text{ k}\Omega$ , $f = 10\text{ ... }50\text{ Hz}$	$V_n$	-	-	0.135	$\mu\text{V}$

**Total power dissipation  $P_{tot} = f(T_A^*; T_S)$**

\* Package mounted on epoxy

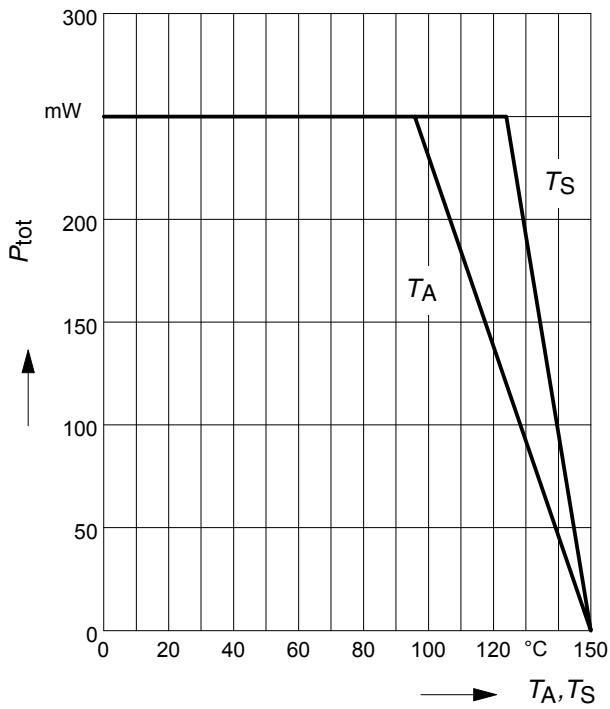

**Collector-base capacitance  $C_{CB} = f(V_{CB0})$**

**Emitter-base capacitance  $C_{EB} = f(V_{EB0})$**

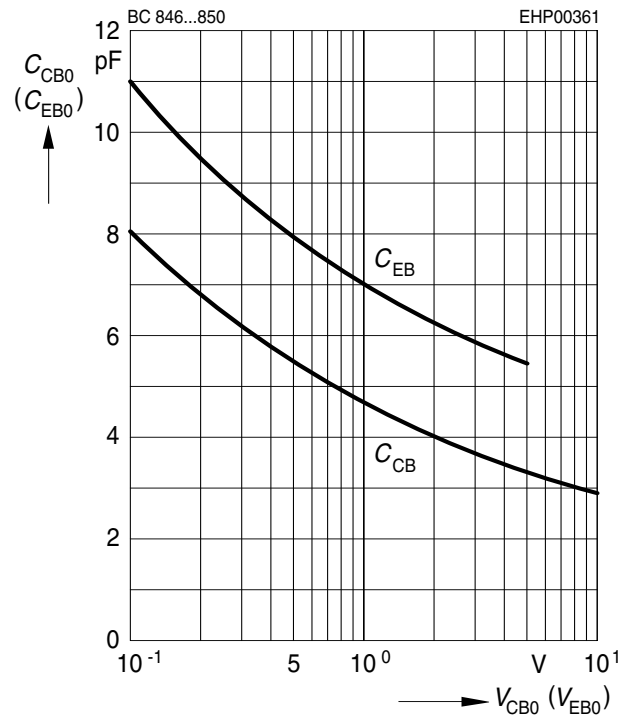

**Permissible pulse load**

$P_{totmax} / P_{totDC} = f(t_p)$

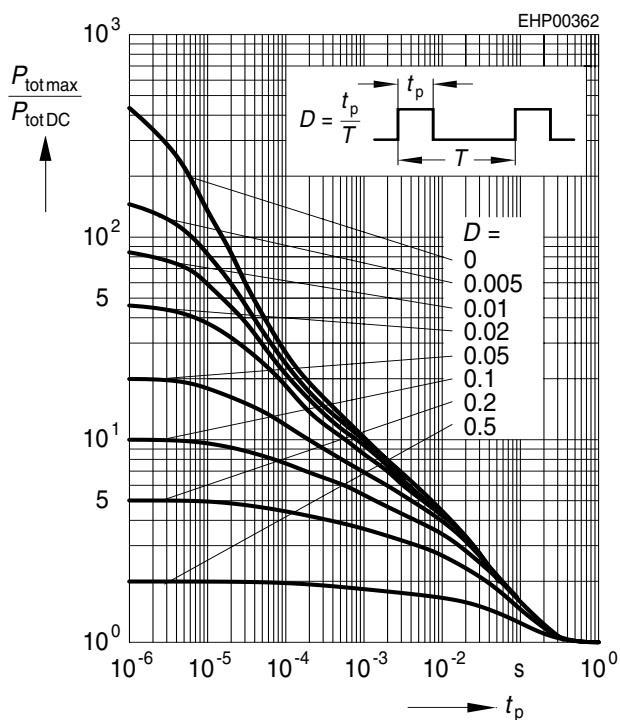

**Transition frequency  $f_T = f(I_C)$**

$V_{CE} = 5V$

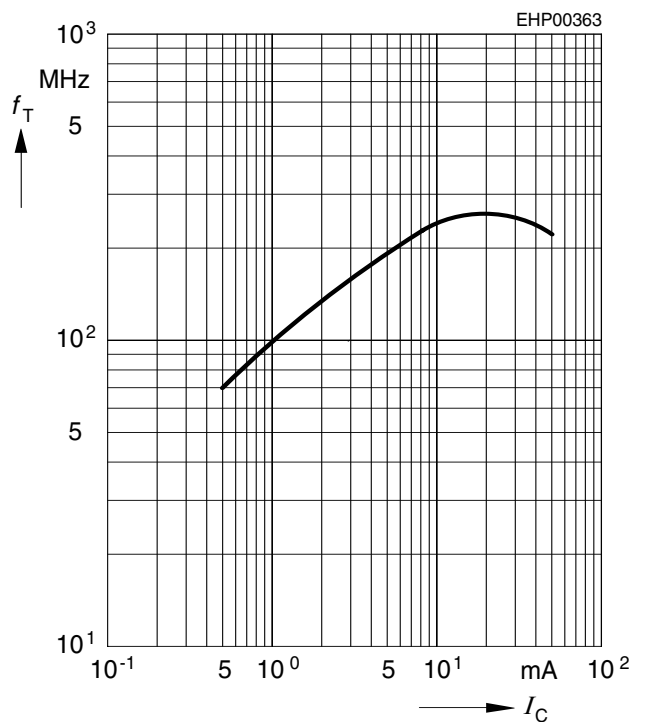

**Collector cutoff current  $I_{CBO} = f(T_A)$**

$V_{CB} = 30V$

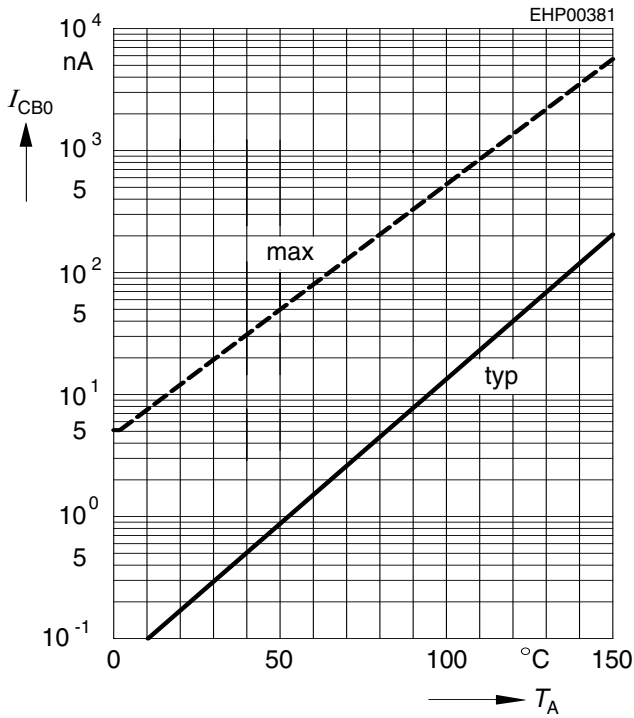

**Collector-emitter saturation voltage**

$I_C = f(V_{CEsat}), h_{FE} = 20$

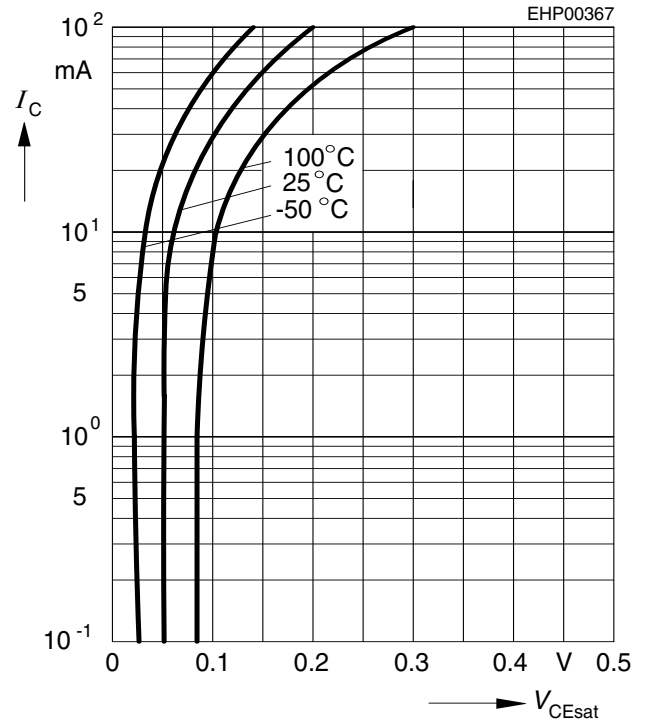

**DC current gain  $h_{FE} = f(I_C)$**

$V_{CE} = 5V$

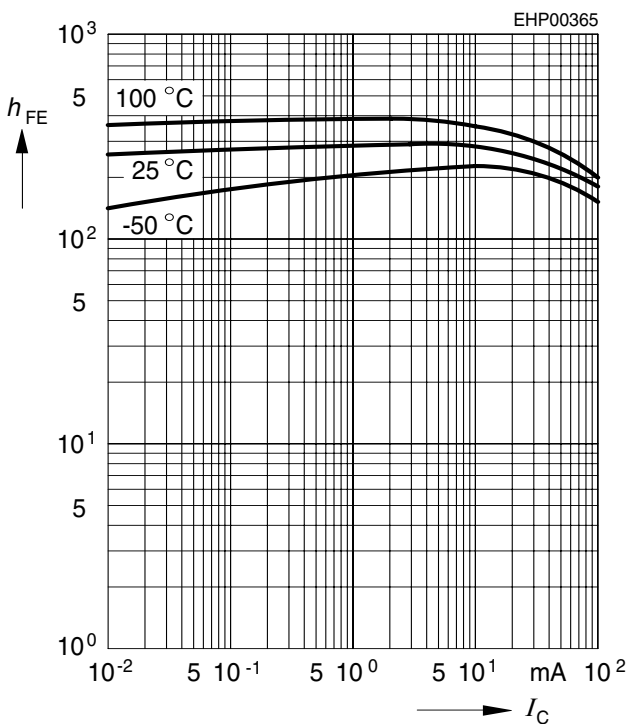

**Base-emitter saturation voltage**

$I_C = f(V_{BEsat}), h_{FE} = 20$

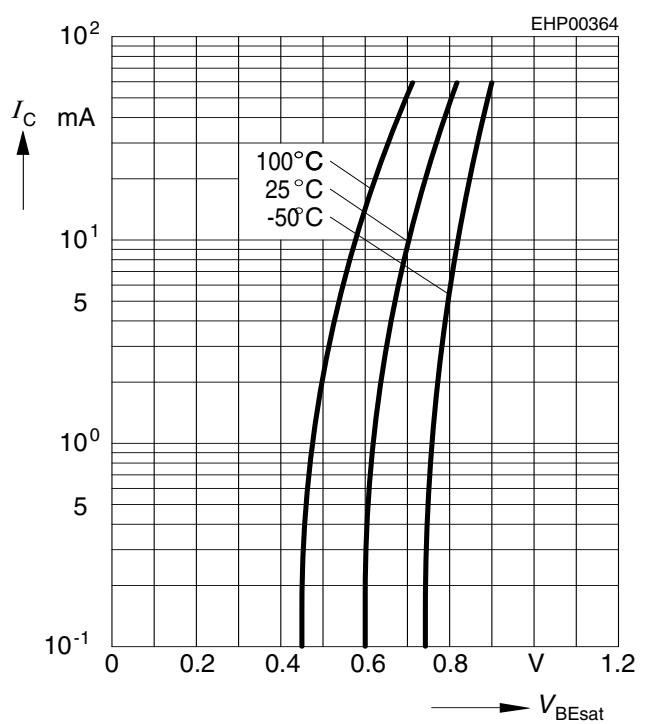

**h parameter  $h_e = f(I_C)$  normalized**

$V_{CE} = 5V$

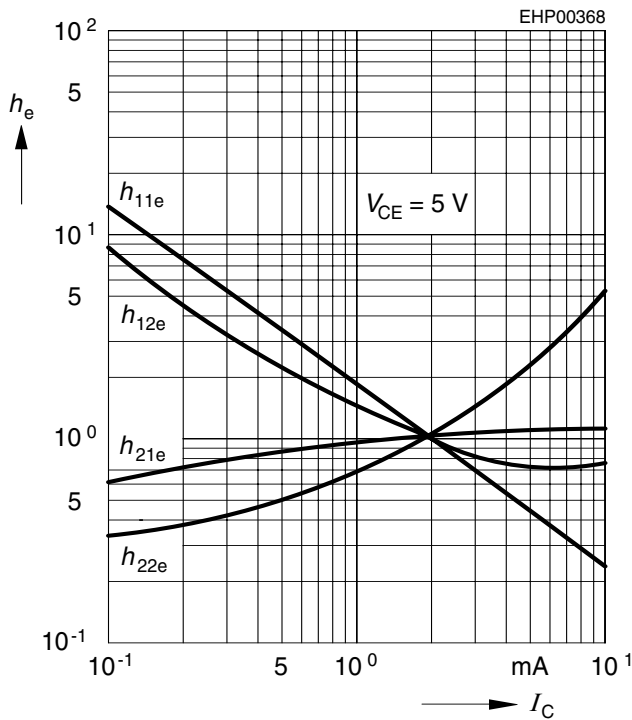

**h parameter  $h_e = f(V_{CE})$  normalized**

$I_C = 2mA$

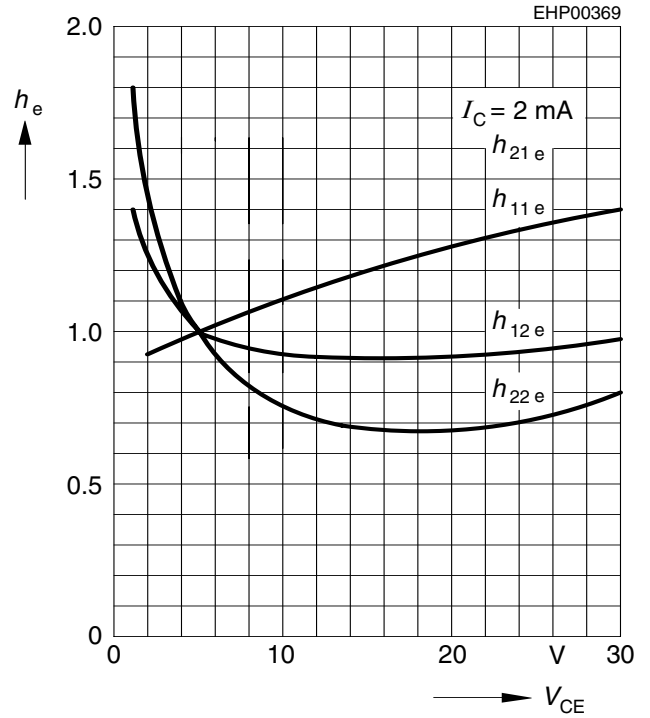

**Noise figure  $F = f(V_{CE})$**

$I_C = 0.2mA, R_S = 2k\Omega, f = 1kHz$

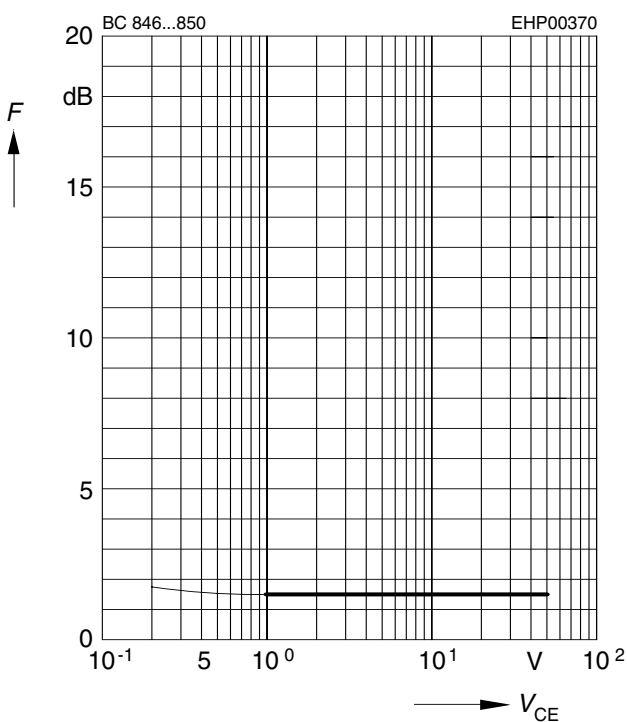

**Noise figure  $F = f(f)$**

$I_C = 0.2mA, V_{CE} = 5V, R_S = 2k\Omega$

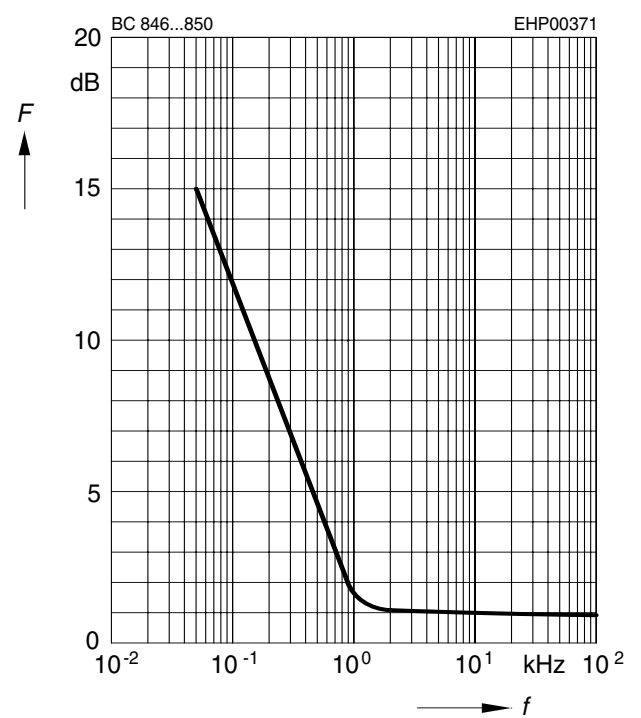

**Noise figure  $F = f(I_C)$**

$V_{CE} = 5V, f = 120Hz$

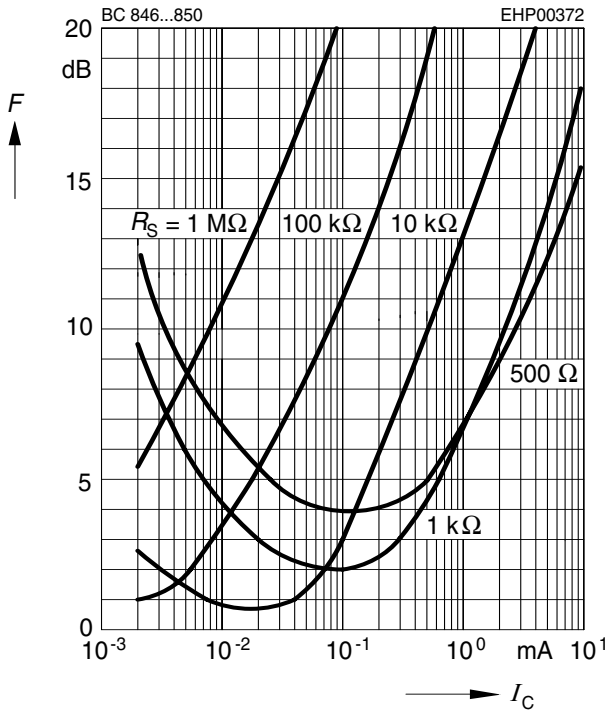

**Noise figure  $F = f(I_C)$**

$V_{CE} = 5V, f = 1kHz$

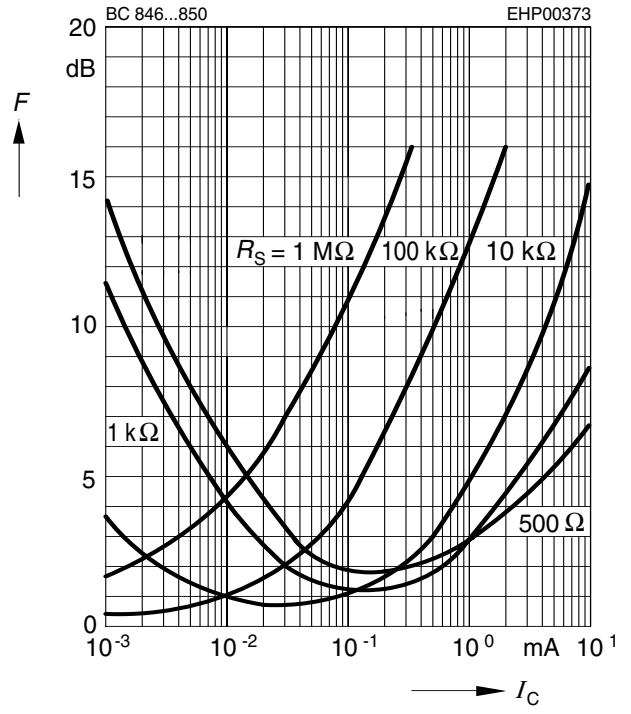

**Noise figure  $F = f(I_C)$**

$V_{CE} = 5V, f = 10kHz$

