

MITSUBISHI RF POWER TRANSISTOR 2SC2134

NPN EPITAXIAL PLANAR TYPE

DESCRIPTION

2SC2134 is a silicon NPN epitaxial planar type transistor designed for RF power amplifiers in VHF band 24 to 28 volts operation applications.

FEATURES

- High power gain: $G_{pe} \geq 7\text{dB}$
@ $V_{CC} = 28\text{V}$, $P_O = 60\text{W}$, $f = 220\text{MHz}$
- Emitter ballasted construction and gold metallization for high reliability and good performances.
- Low thermal resistance ceramic package with flange.
- Ability of withstanding more than 20:1 load VSWR when operated at $V_{CC} = 28\text{V}$, $P_O = 50\text{W}$, $f = 220\text{MHz}$, $T_C = 25^\circ\text{C}$.
- Equivalent input series impedance: $Z_{in} = 1 + j3\Omega$
@ $V_{CC} = 28\text{V}$, $P_O = 60\text{W}$, $f = 220\text{MHz}$

APPLICATION

20 to 30 watts output linear power amplifiers such as TV transposer amplifiers in VHF band.

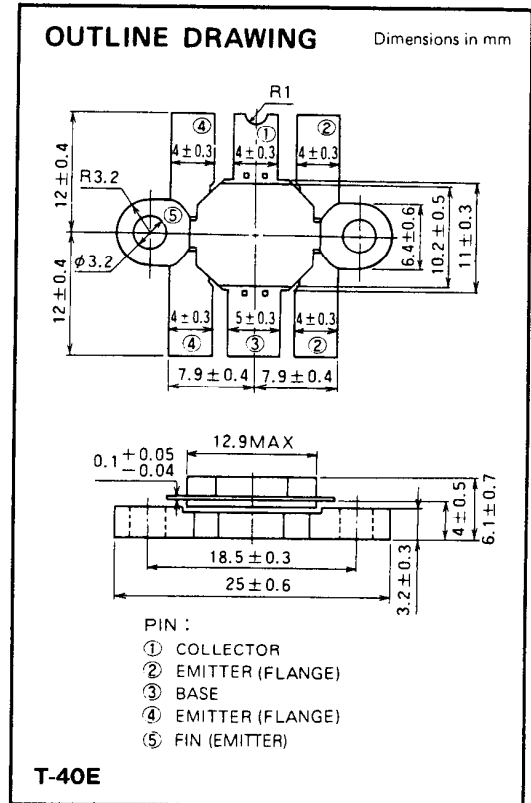

ABSOLUTE MAXIMUM RATINGS ($T_C = 25^\circ\text{C}$ unless otherwise specified)

Symbol	Parameter	Conditions	Ratings	Unit
V_{CBO}	Collector to base voltage		55	V
V_{EBO}	Emitter to base voltage		4	V
V_{CEO}	Collector to emitter voltage	$R_{BE} = \infty$	35	V
I_C	Collector current		10	A
P_C	Collector dissipation	$T_a = 25^\circ\text{C}$	4	W
		$T_C = 25^\circ\text{C}$	120	W
T_j	Junction temperature		175	$^\circ\text{C}$
T_{stg}	Storage temperature		-55 to 175	$^\circ\text{C}$
R_{th-a}	Thermal resistance	Junction to ambient	37.5	$^\circ\text{C}/\text{W}$
R_{th-c}		Junction to case	1.25	$^\circ\text{C}/\text{W}$

Note. Above parameters are guaranteed independently.

ELECTRICAL CHARACTERISTICS ($T_C = 25^\circ\text{C}$ unless otherwise specified)

Symbol	Parameter	Test conditions	Limits			Unit
			Min	Typ	Max	
$V_{(BR)EBO}$	Emitter to base breakdown voltage	$I_E = 10\text{mA}$, $I_C = 0$	4			V
$V_{(BR)CBO}$	Collector to base breakdown voltage	$I_C = 50\text{mA}$, $I_E = 0$	55			V
$V_{(BR)CEO}$	Collector to emitter breakdown voltage	$I_C = 0.1\text{A}$, $R_{BE} = \infty$	35			V
I_{CBO}	Collector cutoff current	$V_{CB} = 35\text{V}$, $I_E = 0$			5	mA
I_{EBO}	Emitter cutoff current	$V_{EB} = 3\text{V}$, $I_C = 0$			2	mA
h_{FE}	DC forward current gain *	$V_{CE} = 25\text{V}$, $I_C = 0.2\text{A}$	20	50	110	—
P_O	Output power	$V_{CC} = 28\text{V}$, $P_{in} = 12\text{W}$, $f = 220\text{MHz}$	60	70		W
η_C	Collector efficiency		55	60		%

Note. * Pulse test, $P_W = 150\mu\text{s}$, duty = 5%.

Above parameters, ratings, limits and conditions are subject to change.

NOV. '97

TEST CIRCUIT

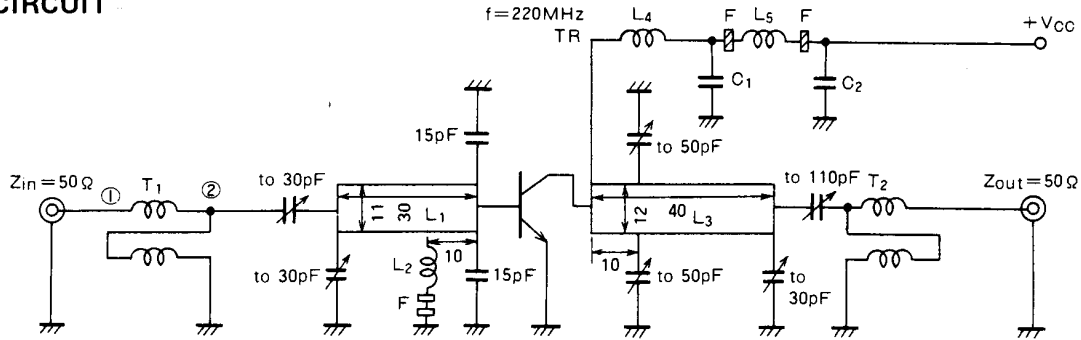

- L₁, L₃: t = 0.2mm copper plate
- L₂: 10D, 7T, 2P, φ1.0 silver plated copper wire
- L₄: 12D, 3T, 3P, φ1.6 silver plated copper wire
- L₅: 10D, 15T, φ1.0 enameled wire
- T₁: 4:1 transformer
- T₂: 1:4 transformer
- F: Ferrite Bead
- C₁: 330pF, 1000pF, 4700pF, 0.01μF, 0.1μF, 4.7μF in parallel
- C₂: 330pF, 1000pF, 4700pF, 0.01μF, 0.1μF, 4.7μF in parallel

Notes: Coil
D: Inner diameter
P: Pitch
T: Turn number
Dimension in milli-meter

TYPICAL PERFORMANCE DATA

COLLECTOR DISSIPATION VS. AMBIENT TEMPERATURE

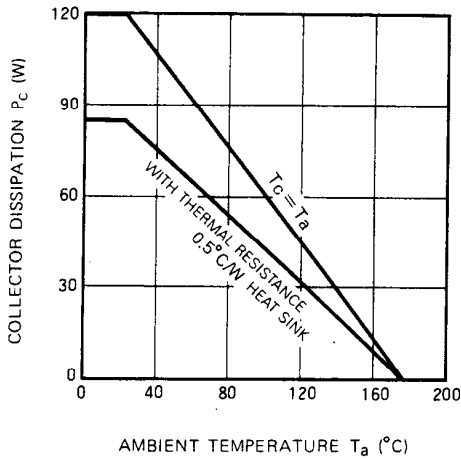

COLLECTOR CURRENT VS. COLLECTOR TO EMITTER VOLTAGE

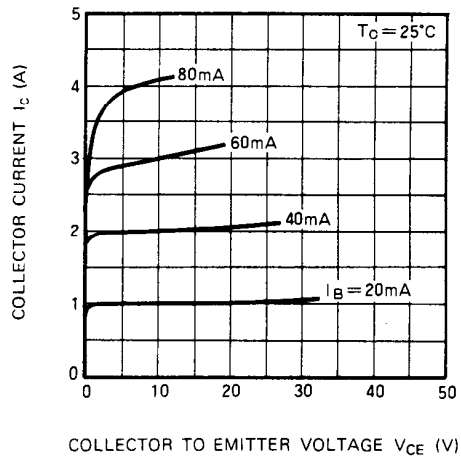

COLLECTOR TO EMITTER BREAKDOWN VOLTAGE VS. BASE TO EMITTER RESISTANCE

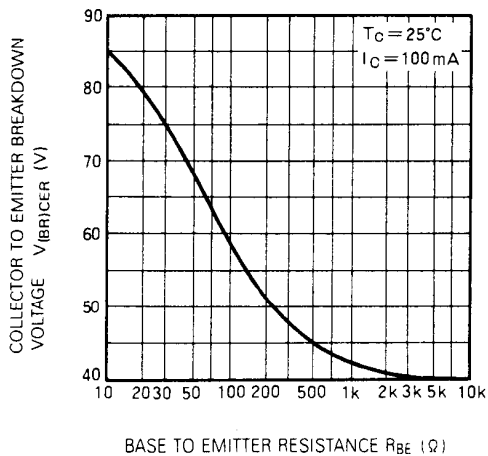

DC CURRENT GAIN VS. COLLECTOR CURRENT

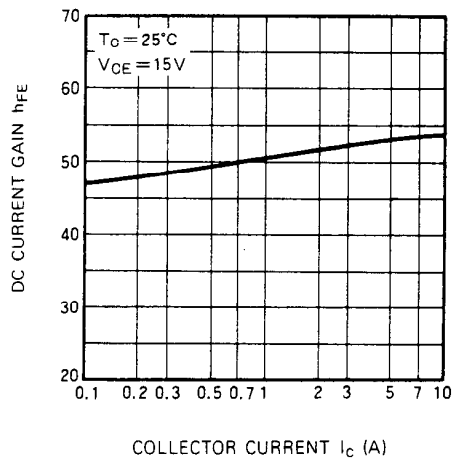

NPN EPITAXIAL PLANAR TYPE

COLLECTOR OUTPUT CAPACITANCE VS. COLLECTOR TO BASE VOLTAGE

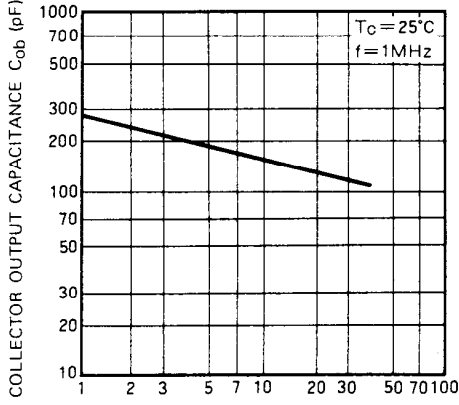

COLLECTOR TO BASE VOLTAGE V_{cb} (V)

OUTPUT POWER, COLLECTOR EFFICIENCY VS. INPUT POWER

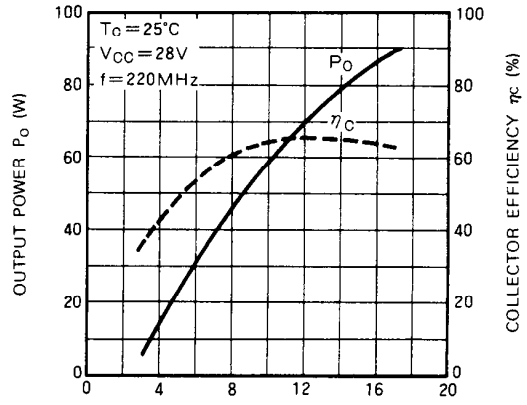

INPUT POWER P_{in} (W)

OUTPUT POWER VS. COLLECTOR SUPPLY VOLTAGE

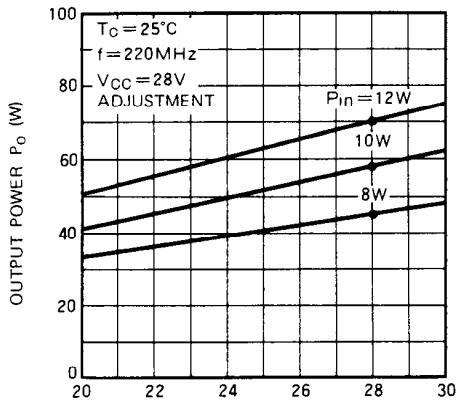

COLLECTOR SUPPLY VOLTAGE V_{CC} (V)

IN CASE AB OPERATING OUTPUT POWER, COLLECTOR CURRENT VS. INPUT POWER

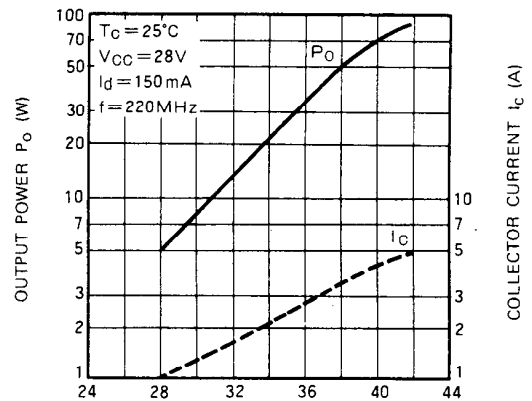

INPUT POWER P_{in} (dBm)

INPUT IMPEDANCE VS. FREQUENCY

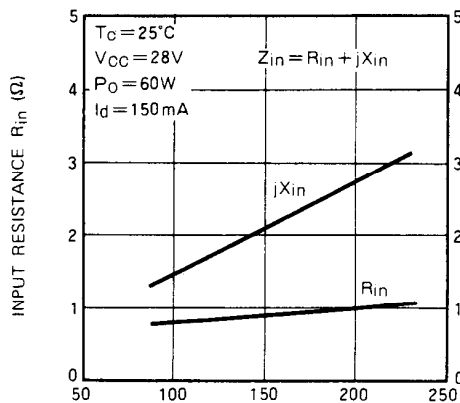

FREQUENCY f (MHz)

OUTPUT IMPEDANCE VS. FREQUENCY

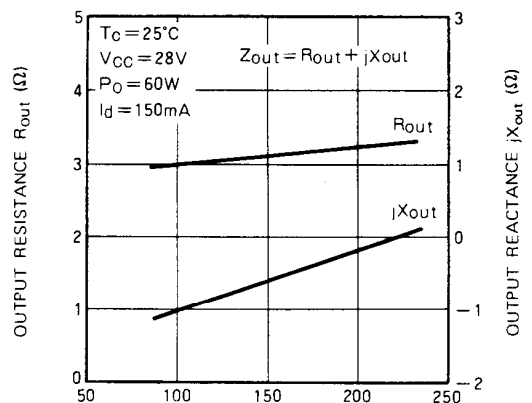

FREQUENCY f (MHz)