

Fast Recovery Diodes (Stud Version)

Features

- Diffused Series
- Industrial grade
- Available in Normal and Reverse polarity
- Optional Avalanche Characteristic

Electrical Specifications ($T_E = 25^{\circ}\text{C}$, unless otherwise noted)			
Symbol	Parameters	Values	Units
$I_{F(AV)}$	Maximum avg. forward current @ $T_E = 150^{\circ}\text{C}$	25	A
V_{FM}	Maximum peak forward voltage drop @ rated $I_{F(AV)}$	1.4	V
I_{FSM}	Maximum peak one cycle (non-rep) surge current @ 10 msec	250	A
I_{FRM}	Maximum peak repetitive surge current	80	A
I^2t	Maximum I^2t rating (non-rep) for 5 to 10 msec	800	A^2sec
T_{rr}	Reverse recovery time	300	ns



DO-203AB (DO-5)

Electrical Ratings ($T_E = 25^{\circ}\text{C}$, unless otherwise noted)						
Type number	Voltage Code	V_{RRM} , Maximum repetitive peak reverse voltage (V)	$V_{R(RMS)}$, Maximum RMS reverse voltage (V)	V_R , Maximum DC blocking voltage (V)	Recommended RMS working voltage (V)	$I_{R(AV)}$, Maximum avg. reverse leakage current (μA)
25NSF(R)	10	100	70	100	40	100
	20	200	140	200	80	
	40	400	280	400	160	
	60	600	420	600	240	
	80	800	560	800	320	
	100	1000	700	1000	400	
	120	1200	840	1200	480	
	140	1400	980	1400	560	
	160	1600	1120	1600	640	

Thermal & Mechanical Specifications ($T_E = 25^{\circ}\text{C}$, unless otherwise noted)			
Symbol	Parameters	Values	Units
$R_{th(jc)}$	Maximum thermal resistance, junction to case	2.5	$^{\circ}\text{C}/\text{W}$
T_J	Operating junction temperature range	-65 to 150	$^{\circ}\text{C}$
T_{stg}	Storage temperature	-65 to 150	$^{\circ}\text{C}$
	Mounting torque (non-lubricated threads)	0.14 (min) - 0.17 (max)	
W	Approximate allowable weight	7	g

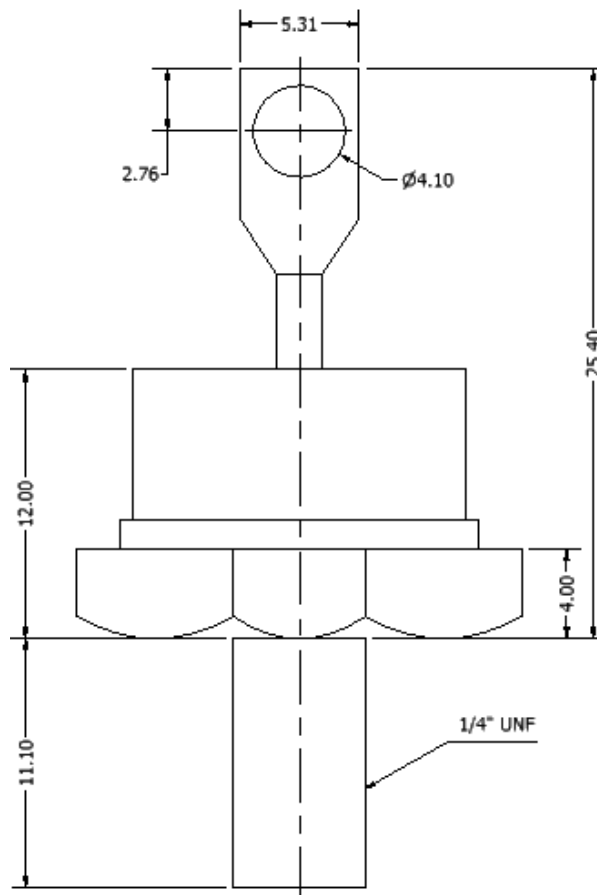
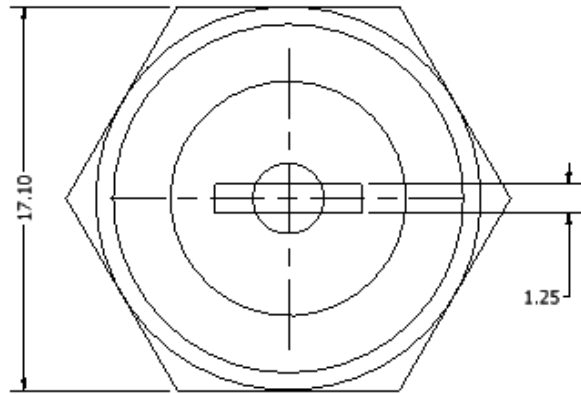

ALL DIMENSIONS ARE IN MM