

## IMT-901 Mikroschritt-Treiber

Der IMT-901 ist ein Mikroschritt-PWM-Konstantstrom-Treiber. Sinusähnlicher Mikroschritt wird hardwaremäßig im Baustein IMT 901 erzeugt und durch Impulseingänge am Leistungsausgang zur Verfügung gestellt.

### Vorteile:

- nur 1 IC für Leistung und Logik (bis 2,5 A/Phase) reduziert erheblich den Platzbedarf, Bestückungsaufwand u. somit die Kosten eines kompl. Mikroschritt-Treibers bei einem Minimum an externen Bauelementen und einem Maximum an Funktionen
- 1/1-, 1/2-, 1/4-, 1/8-Schrittschaltung ermöglicht eine individuelle anwendungsbezogene Mikroschritt-Umschaltung mit ruhigem, gleichförmigen Laufverhalten und reduzierten Systemresonanzen
- Stromreduzierung oder Stromnullung reduziert bzw. eliminiert die Verlustleistung u. Erwärmung im Motorstillstand



- Passende Isolier-Wärmeleitfolie (siehe Zubehör)



Kompl. Info im Internet:  
[www.nanotec.de](http://www.nanotec.de)

### Maßbild (mm)

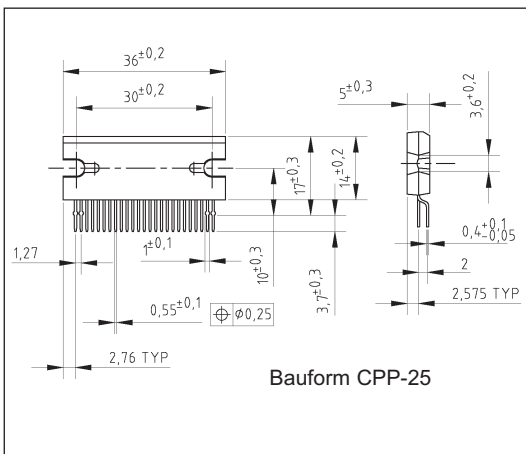

### PIN-Belegung

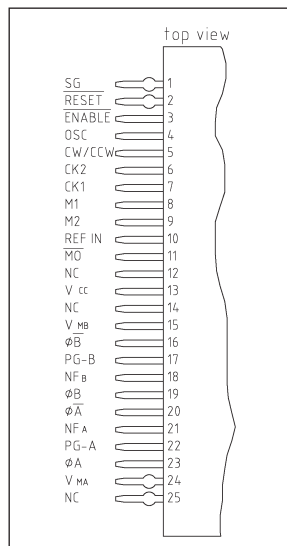

### max. Nennwerte (bei 25°C)

Vers. Spannung $V_{CC}$ :	5,5 V
$V_M$ :	40 V
Ausg. Strom $I_{out}$ :	1,5 A (mittel) 2,5 A (spitze)
Verl. Leistung $P_d$ :	5 W/43 W ohne/mit Kühlkörper $T_C=85^\circ\text{C}$
max. Taktfrequenz:	50kHz
Arbeitstemp.:	$-40^\circ\text{C}$ bis $85^\circ\text{C}$
Speichertemp.:	$-55^\circ\text{C}$ bis $150^\circ\text{C}$

Input	Mode	
M1	M2	
L	L	1/1 Schritt
H	L	1/2 Schritt
L	H	1/4 Schritt
H	H	1/8 Schritt

Signalschaltzeiten  
 $t_1$ : Pulsbreite >10µs  
 $t_2$ : Pulspause >10µs  
 $t_3$ : > 5µs  
 $t_4$ : >10µs

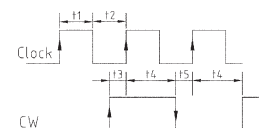

### Eingänge

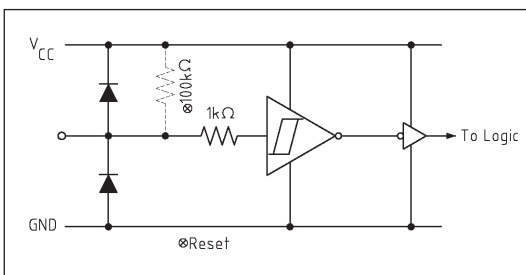

### Ein-/Ausgangssignale

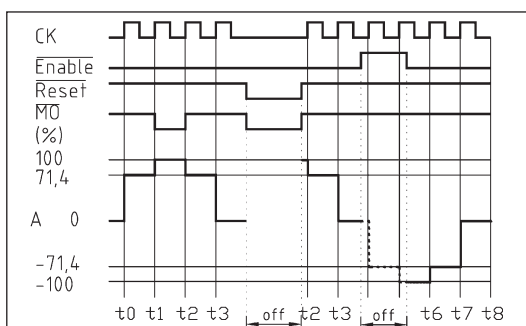

### Temperaturverhalten

- ① INFINITE HEAT SINK  
 $R_{th(j-c)} = 1,5^\circ\text{C/W}$
- ② HEAT SINK  
(with  $3,5^\circ\text{C/W}$  Heat Pin and  $1,5^\circ\text{C}$  contact thermal Resistance; Total  $5^\circ\text{C/W}$ )
- ③ NO HEAT SINK  
 $R_{th(j-a)} = 25^\circ\text{C/W}$

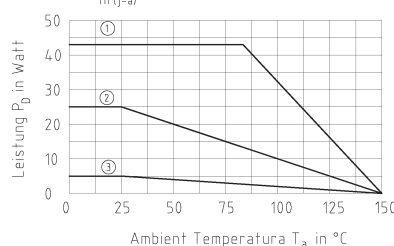

### TRANSIENT THERMAL RESISTANCE

- ① 2C/W HEAT SINK
- ② NO HEAT SINK

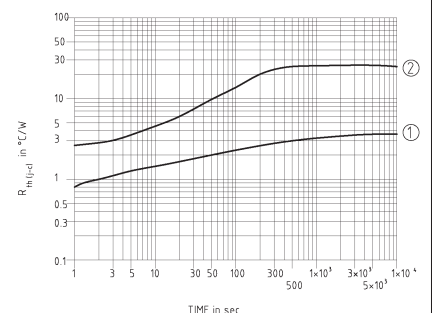

## IMT-901

### Funktionstabelle

INPUT					MODE
CK1	CK2	CW/CCW	Enable	Reset	
	H	L	L	H	CW
	L	L	L	H	INHIBIT
		L	L	H	CCW
		L	L	L	INHIBIT
	H	H	L	H	CCW
	L	H	L	H	INHIBIT
		H	L	H	CW
		H	L	H	INHIBIT
X	X	X	H	H	Z
X	X	X	X	L	Z

### Blockdiagramm (+ externe Beschaltung)

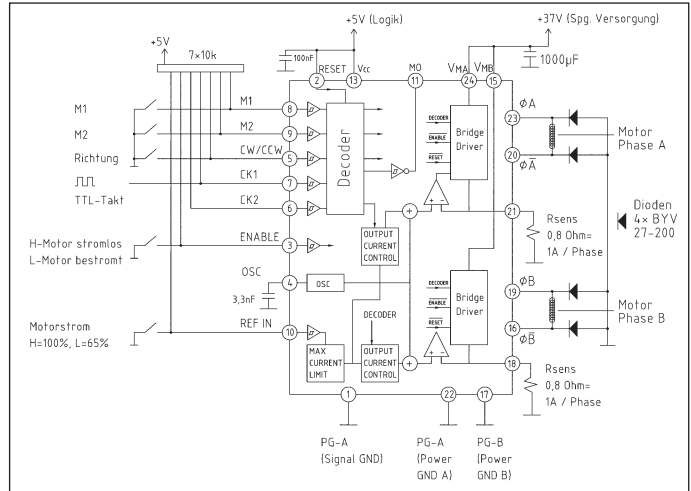

### Voll-/Halbschritt-Betrieb

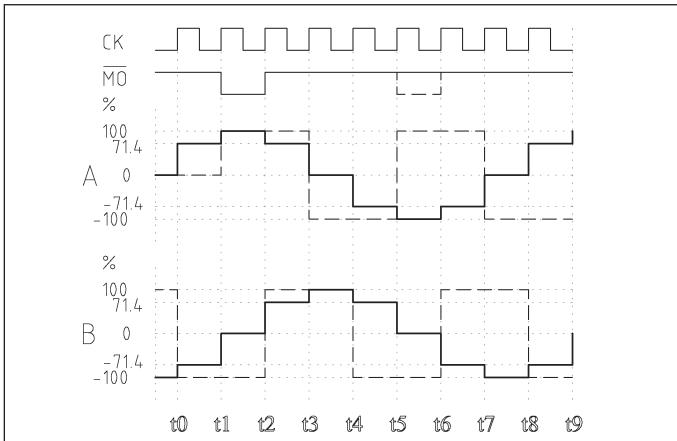

### Viertel-/Achtelschritt-Betrieb

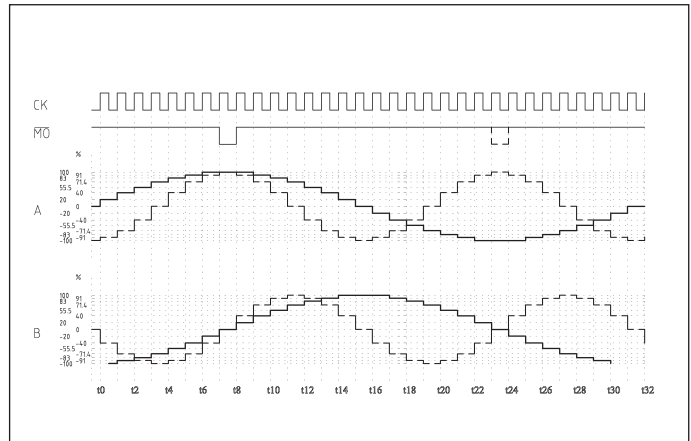

### Elektrische Kennwerte 1 (Ta=25°, VCC=5V, VM=24V)

ELECTRICAL CHARACTERISTICS (Ta = 25° C, VCC=5V, VM=24V)								
CHARACTERISTICS	SYMBOL	TEST CIRCUIT	TEST CONDITION	MIN.	TYP.	MAX.		
NF Terminal Current	$I_{NF}$	-	SOURCE TYPE	-	170	-		
OSC Frequency	$f_{OSC}$	-	$C_{OSC}=0.0033\mu F$	25	44	62		
Output Saturation Voltage	$V_{SAT(U2)}$	Upper Side	$I_{OUT}=0.9 A$	-	1.8	2.2		
		Lower Side	-	-	1.1	1.5		
A-B CHOPPING CURRENT (Note 1)	VECTOR	2W1-2a	W1-2a	1-2a	$\theta=0/8$	-	100	
		2W1-2a	-	-	$\theta=1/8$	-	100	
		2W1-2a	W1-2a	-	$\theta=2/8$	86	91	96
		2W1-2a	-	-	$\theta=3/8$	78	83	88
		2W1-2a	W1-2a	1-2a	$\theta=4/8$	66.4	71.4	76.4
		2W1-2a	-	-	$\theta=5/8$	50.5	55.5	60.5
		2W1-2a	W1-2a	-	$\theta=6/8$	35	40	45
		2W1-2a	-	-	$\theta=7/8$	15	20	25
2 Phase excitation mode VECTOR	-	-	-	-	141	-		
Feed Back Voltage Step	$\Delta V_{NF}$	-	$\Delta\theta=0/8-1/8$	-	0	-		
			$\Delta\theta=1/8-2/8$	32	72	112		
			$\Delta\theta=2/8-3/8$	24	64	104		
			$\Delta\theta=3/8-4/8$	53	93	133		
			$\Delta\theta=4/8-5/8$	87	127	167		
			$\Delta\theta=5/8-6/8$	84	124	164		
Output T <sub>r</sub> Switching Characteristics	$t_r$	-	$R_L=2\Omega, V_{NF}=0V, C_L=15pF$	-	0.3	-		
			$t_{rH}$	-	1.5	-		
			$t_{rL}$	-	2.7	-		
			$t_{rH}$	-	5.4	-		
			$t_{rL}$	-	6.3	-		
			$t_{rH}$	-	2.0	-		
			$t_{rL}$	-	2.5	-		
			$t_{rH}$	-	5.0	-		
Output Leakage Current	$I_{OL}$	Upper Side	$V_{NF}=30V$	-	-	50		
		Lower Side	-	-	-	50		
Output Voltage	$V_{OH(MO)}$	-	$I_{OH}=-40\mu A$	4.5	4.9	$V_{CC}$		
			$I_{OL}=40\mu A$	GND	4.1	0.5		

Note : Maximum Current ( $\theta=0$ ) : 100%  
 2W1-2a: 2W1, 2 phase excitation mode  
 W1-2a: W1, 2 phase excitation mode  
 1-2a: 1, 2 phase excitation mode

### Elektrische Kennwerte 2 (Ta=25°, VCC=5V, VM=24V)

CHARACTERISTIC	SYMBOL	TEST CIRCUIT	TEST CONDITION	MIN.	TYP.	MAX.	UNIT
Input Voltage	High	$V_{IN(H)}$	M1, M2, CW/CCW, REF IN	3.5	-	$V_{CC}+0.4$	V
	Low	$V_{IN(L)}$	ENABLE, CK1, CK2 RESET	GND-0.4	-	1.5	
Input Hysteresis Voltage	$V_{IH}$	-	-	-	600	-	mV
Input Current	$I_{IN-1(H)}$	-	M1, M2, REF IN, ENABLE $V_{IN} = 5.0 V$	-	-	100	nA
	$I_{IN-1(L)}$	-	RESET, $V_{IN}=0 V$ INTERNAL PULL-UP-RESISTOR	10	50	100	$\mu A$
	$I_{IN-2(L)}$	-	SOURCE TYPE, $V_{IN} = 0 V$	-	-	100	nA
Quiescent Current	$V_{CC}$	$I_{CC1}$	Output Open RESET : H ENABLE : L (2,1 - 2 Phase excitation)	-	10	18	mA
	$V_{CC}$	$I_{CC2}$	Output Open (W1-2, 2W1-2 Phase excitation) RESET : H ENABLE : L	-	10	18	
	$V_{CC}$	$I_{CC3}$	RESET : L, ENABLE : L	-	5	-	
Comparator Reference Voltage	$V_{NF(H)}$	-	REF IN H Output Open	0.72	0.8	0.88	V
	$V_{NF(L)}$	-	REF IN H Output Open	0.45	0.5	0.55	
Output Differential	$\Delta V_O$	-	B/A $C_{OSC} = 0.0033 \mu F, R_{NF} = 0.8 \Omega$	-10	-	10	%
$V_{NF(H)} - V_{NF(L)}$	$\Delta V_{NF}$	-	$V_{NF(L)}/V_{NF(H)}$ $C_{OSC} = 0.0033 \mu F, R_{NF} = 0.8 \Omega$	56	63	70	%
Output Voltage	$V_{OH(MO)}$	-	$I_{OH} = -40 \mu A$	4.5	4.9	$V_{CC}$	mV
	$V_{OL(MO)}$	-	$I_{OH} = -40 \mu A$	GND	0.1	0.5	