

# ST 2SA1664U

## PNP Epitaxial Planar Transistor

High Current Application

The transistor is subdivided into two groups, O and Y, according to its DC current gain.

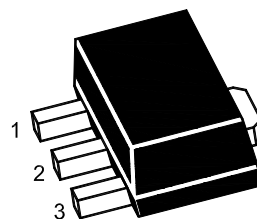

1.Base 2.Collector 3.Emitter  
SOT-89 Plastic Package

### Absolute Maximum Ratings ( $T_a = 25\text{ }^\circ\text{C}$ )

Parameter	Symbol	Value	Unit
Collector Base Voltage	$-V_{CBO}$	35	V
Collector Emitter Voltage	$-V_{CEO}$	30	V
Emitter Base Voltage	$-V_{EBO}$	5	V
Collector Current	$-I_C$	800	mA
Base Current	$-I_B$	160	mA
Collector Power Dissipation	$P_{tot}$	500	mW
Junction Temperature	$T_j$	150	$^\circ\text{C}$
Storage Temperature Range	$T_s$	-55 to +150	$^\circ\text{C}$

### Characteristics at $T_{amb} = 25\text{ }^\circ\text{C}$

Parameter	Symbol	Min.	Typ.	Max.	Unit	
DC Current Gain at $-V_{CE} = 1\text{ V}$ , $-I_C = 100\text{ mA}$	O	$h_{FE}$	100	-	200	-
	Y	$h_{FE}$	160	-	320	-
		$h_{FE}$	35	-	-	-
at $-V_{CE} = 1\text{ V}$ , $-I_C = 700\text{ mA}$						
Collector Cutoff Current at $-V_{CB} = 35\text{ V}$	$-I_{CBO}$	-	-	100	nA	
Emitter Cutoff Current at $-V_{EB} = 5\text{ V}$	$-I_{EBO}$	-	-	100	nA	
Collector Emitter Breakdown Voltage at $-I_C = 10\text{ mA}$	$-V_{(BR)CEO}$	30	-	-	V	
Base Emitter Voltage at $-V_{CE} = 1\text{ V}$ , $-I_C = 10\text{ mA}$	$-V_{BE}$	0.5	-	0.8	V	
Collector Output Capacitance at $-V_{CB} = 10\text{ V}$ , $f = 1\text{ MHz}$	$C_{ob}$	-	19	-	pF	
Collector Emitter Saturation Voltage at $-I_C = 500\text{ mA}$ , $-I_B = 20\text{ mA}$	$-V_{CE(sat)}$	-	-	0.7	V	
Transition Frequency at $-V_{CE} = 5\text{ V}$ , $-I_C = 10\text{ mA}$	$f_T$	-	120	-	MHz	

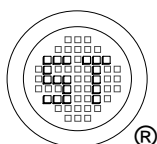

**SEMTECH ELECTRONICS LTD.**

(Subsidiary of Sino-Tech International Holdings Limited, a company listed on the Hong Kong Stock Exchange, Stock Code: 724)



ISO/TS 16949 : 2002  
Certificate No. 05103



ISO 14001:2004  
Certificate No. 7116



ISO 9001:2000  
Certificate No. 0506098

Dated : 22/03/2006

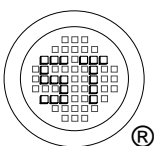
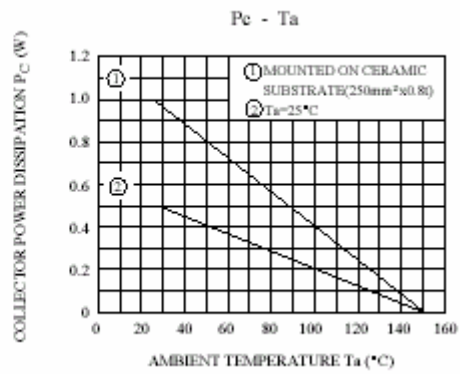
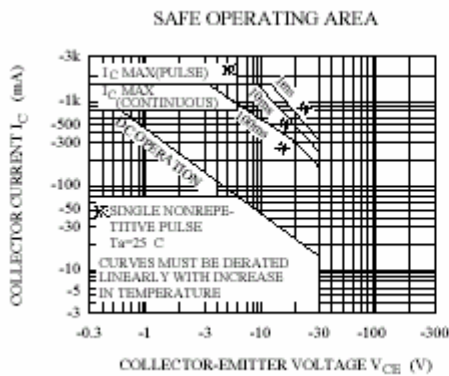
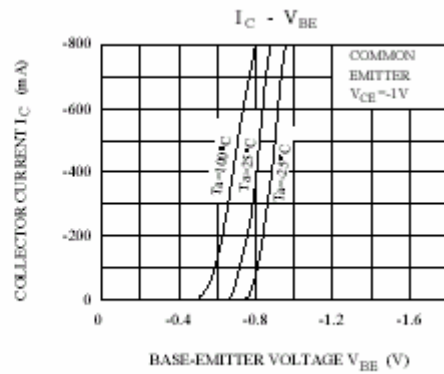
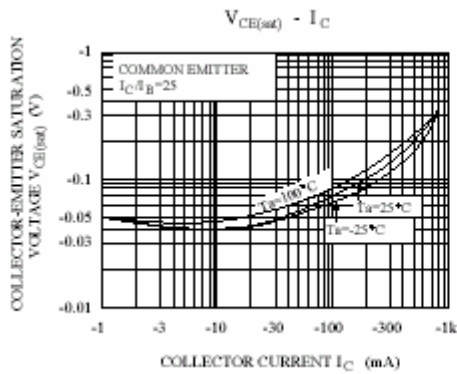
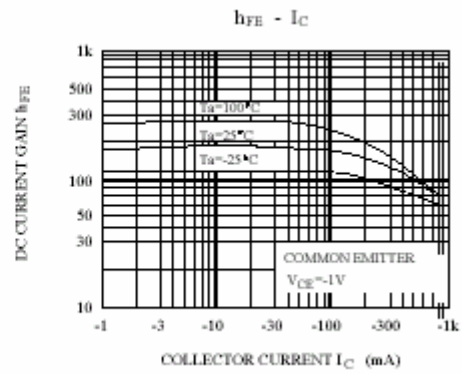
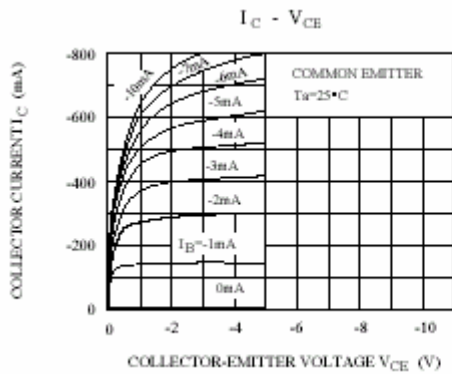

## SEMTECH ELECTRONICS LTD.

(Subsidiary of Sino-Tech International Holdings Limited, a company listed on the Hong Kong Stock Exchange, Stock Code: 724)



ISO/TS 16949:2002  
Certificate No. 05103



ISO 14001:2004  
Certificate No. 7116



ISO 9001:2000  
Certificate No. 0506098

# ST 2SA1664U

## SOT-89 PACKAGE OUTLINE

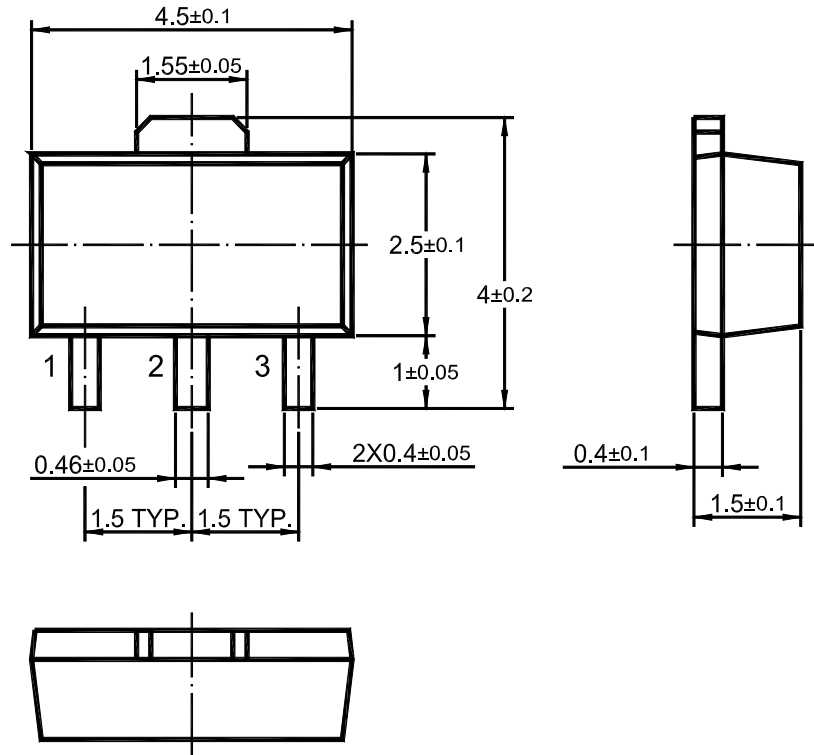

Dimensions in mm

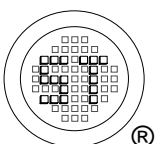

**SEMTECH ELECTRONICS LTD.**

(Subsidiary of Sino-Tech International Holdings Limited, a company listed on the Hong Kong Stock Exchange, Stock Code: 724)



ISO/TS 16949 : 2002  
Certificate No. 05103



ISO 14001:2004  
Certificate No. 7116



ISO 9001:2000  
Certificate No. 0506098

Dated : 22/03/2006