

Typical Applications

The HMC741ST89E is ideal for:

- Cellular/3G & WiMAX/4G
- Fixed Wireless & WLAN
- CATV, Cable Modem & DBS
- Microwave Radio & Test Equipment
- IF & RF Applications

Features

- P1dB Output Power: +18.5 dBm
- Gain: 20 dB
- Output IP3: +42 dBm
- Cascadable 50 Ohm I/Os
- Single Supply: +5V
- Industry Standard SOT89 Package
- Robust 1000V ESD, Class 1C
- Stable Current Over Temperature
- Active Bias Network

Functional Diagram

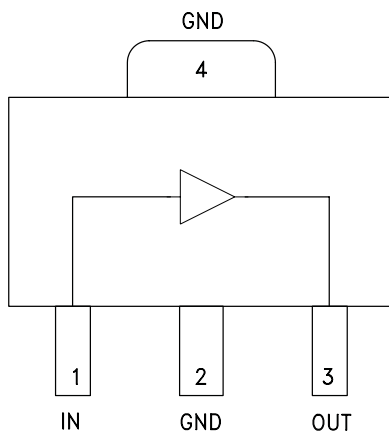

General Description

The HMC741ST89E is an InGaP Heterojunction Bipolar Transistor (HBT) Gain Block MMIC SMT amplifier covering 0.05 to 3 GHz. Packaged in an industry standard SOT89, the amplifier can be used as a cascadable 50 Ohm RF or IF gain stage as well as a PA or LO driver with up to +18.5 dBm output power. The HMC741ST89E offers 20 dB of gain with a +42 dBm output IP3 at 200 MHz, and can operate directly from a +5V supply. The HMC741ST89E exhibits excellent gain and output power stability over temperature, while requiring a minimal number of external bias components.

Electrical Specifications, $V_{cc} = 5V$, $T_a = +25^\circ C$

Parameter	Min.	Typ.	Max.	Min.	Typ.	Max.	Min.	Typ.	Max.	Min.	Typ.	Max.	Units
Frequency Range	150			240			50 - 1000			50 - 3000			MHz
Gain	19	20		19	21		16	20		12	19		dB
Gain Flatness		±0.3			±0.3			±0.3			±2.6		dB
Gain Variation over Temperature		0.004			0.004			0.004	0.01		0.004	0.01	dB/°C
Input Return Loss		16			16			16			12		dB
Output Return Loss		17			17			17			12		dB
Reverse Isolation		25			25			25			26		dB
Output Power for 1 dB Compression (P1dB)	16	18.8		16	18.8		16	18.8		14	16		dBm
Output Third Order Intercept (IP3) (Pout= 0 dBm per tone, 1 MHz spacing)		40.5			40.5			40.5			30		dBm
Noise Figure		2.5			2.5			2.5			2.5		dB
Supply Current (Icc)		96			96			96			96		mA

For price, delivery and to place orders: Hittite Microwave Corporation, 20 Alpha Road, Chelmsford, MA 01824

Phone: 978-250-3343 Fax: 978-250-3373 Order On-line at www.hittite.com

Application Support: Phone: 978-250-3343 or apps@hittite.com



IF Band Performance

HMC741ST89E

InGaP HBT ACTIVE BIAS MMIC AMPLIFIER, 0.05 – 3 GHz

Gain & Return Loss

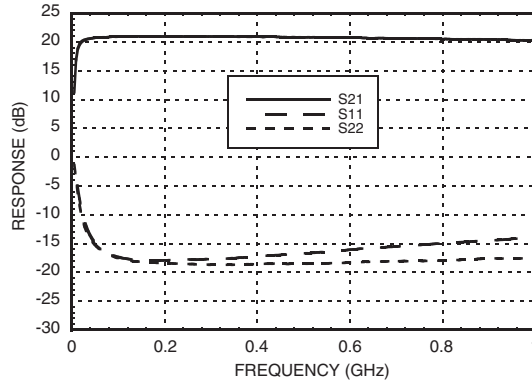

Gain vs. Temperature

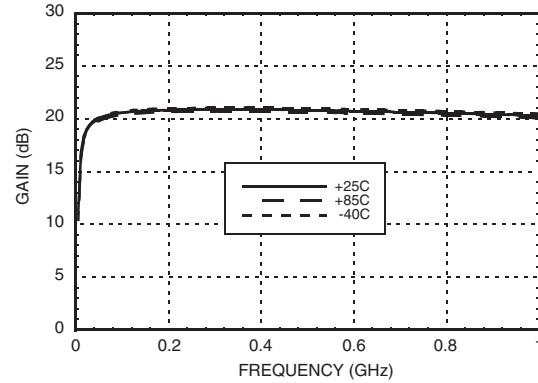

Noise Figure vs. Temperature

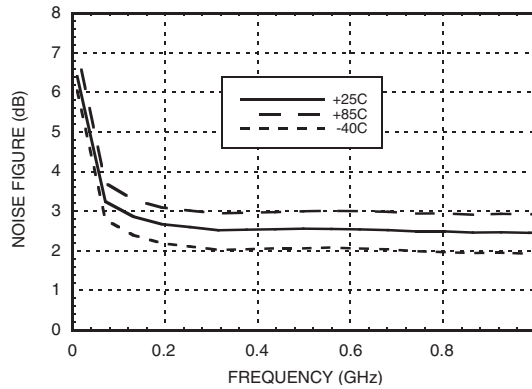

Output IP3 vs. Temperature

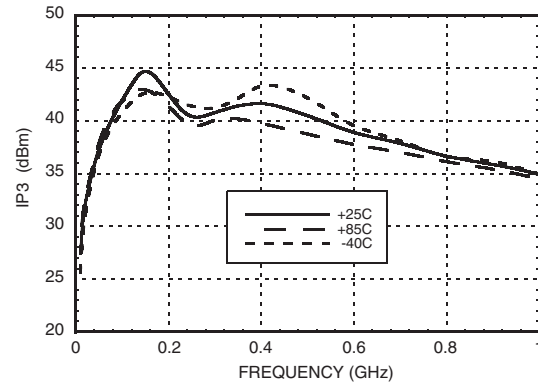

Output IP3 vs. Vcc

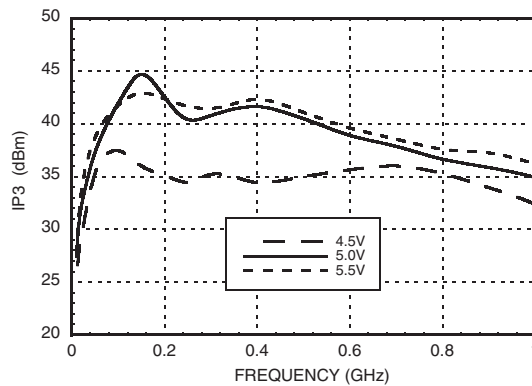

Output IP3 vs. Output Power

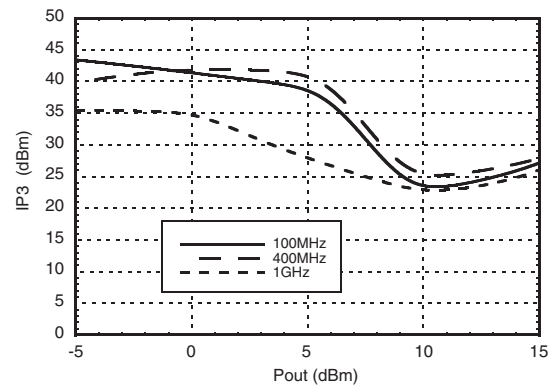

Broadband Performance

Gain & Return Loss

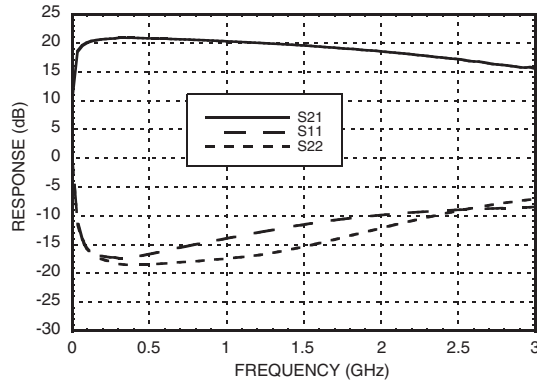

Gain vs. Temperature

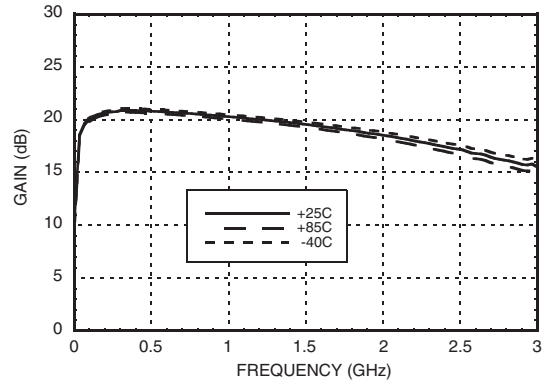

Gain vs. Vcc

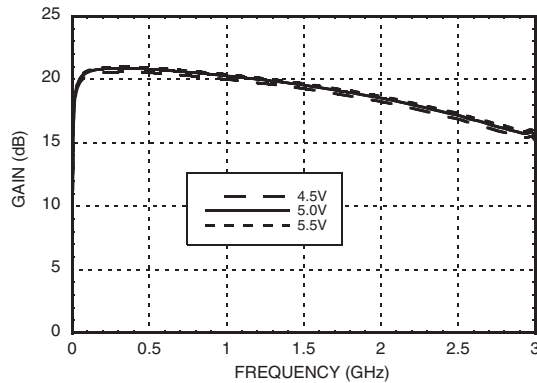

Input Return Loss vs. Temperature

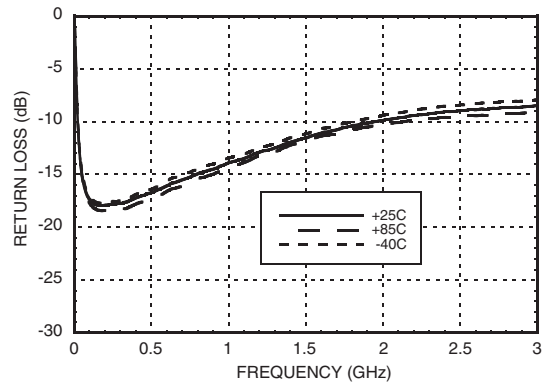

Output Return Loss vs. Temperature

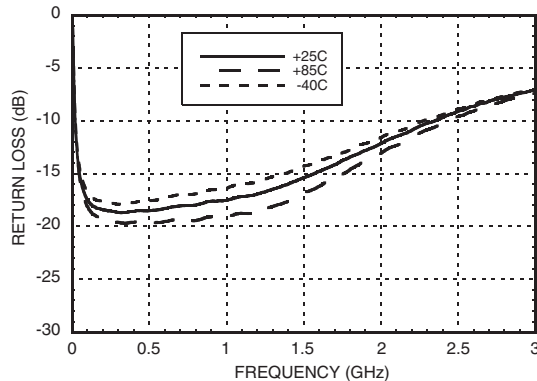

Input Return Loss vs. Vcc

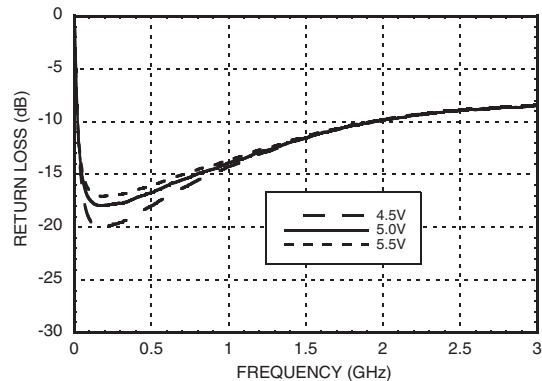

InGaP HBT ACTIVE BIAS MMIC AMPLIFIER, 0.05 – 3 GHz

Output Return Loss vs. Vcc

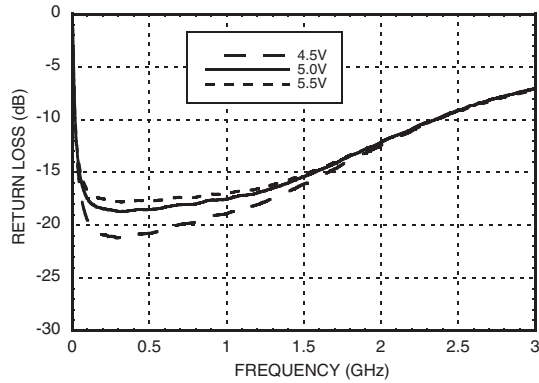

Noise Figure vs. Temperature

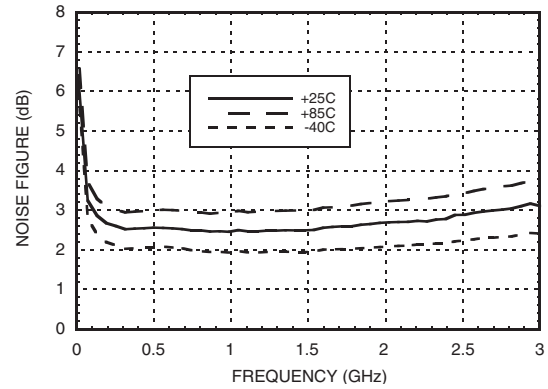

Noise Figure vs. Vcc

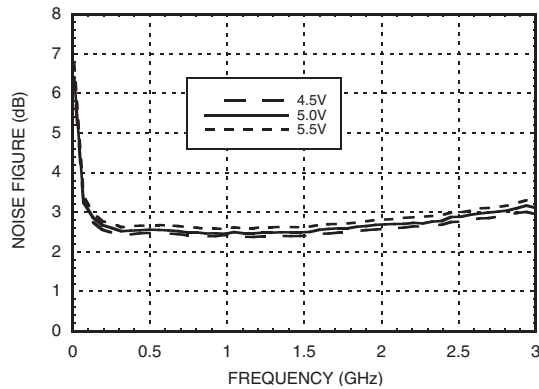

Reverse Isolation vs. Temperature

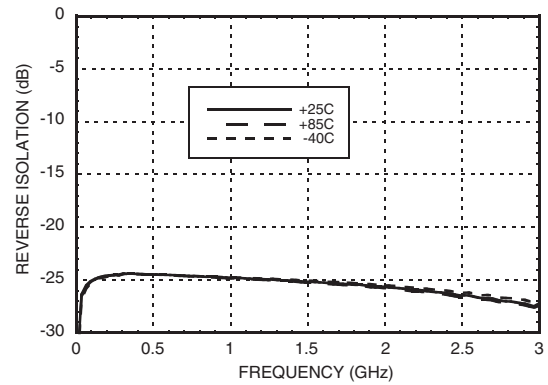

Reverse Isolation vs. Vcc

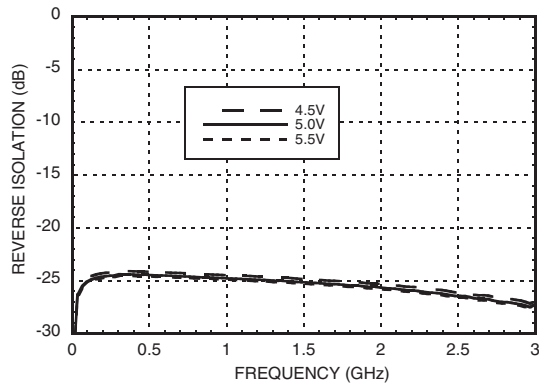

Output IP3 vs. Temperature

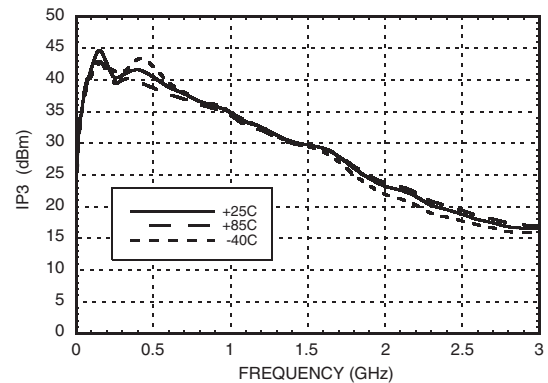

InGaP HBT ACTIVE BIAS MMIC AMPLIFIER, 0.05 – 3 GHz

Output IP3 vs. Vcc

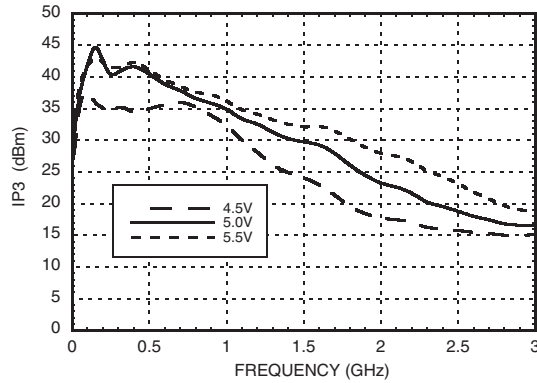

Current vs. Temperature

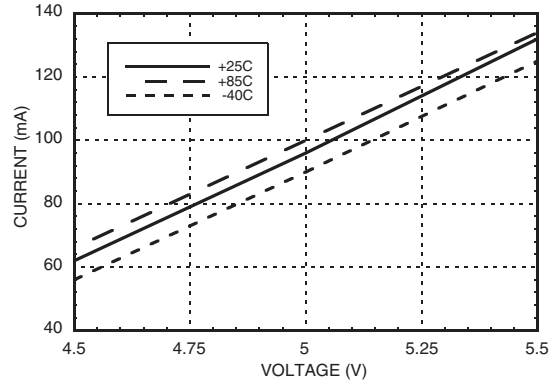

P1dB vs. Temperature

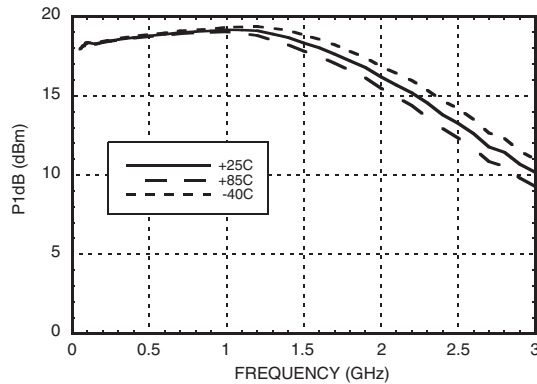

Psat vs. Temperature

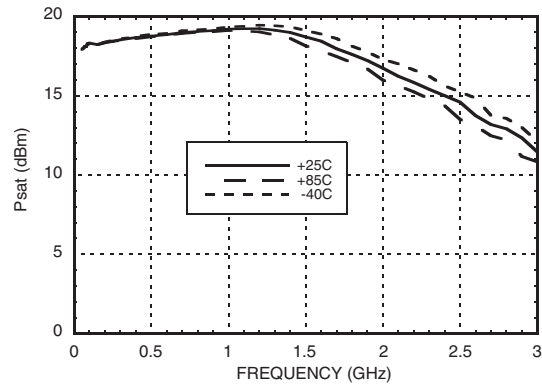

Power Compression @ 500 MHz

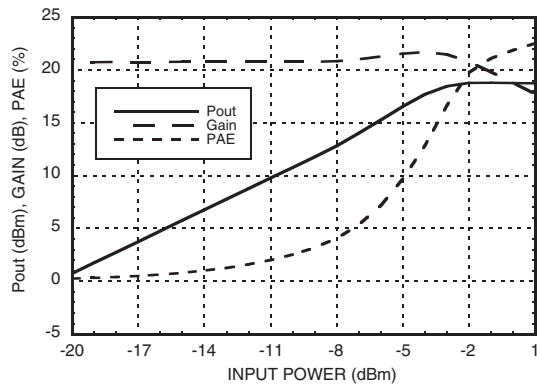

Power Compression @ 2 GHz

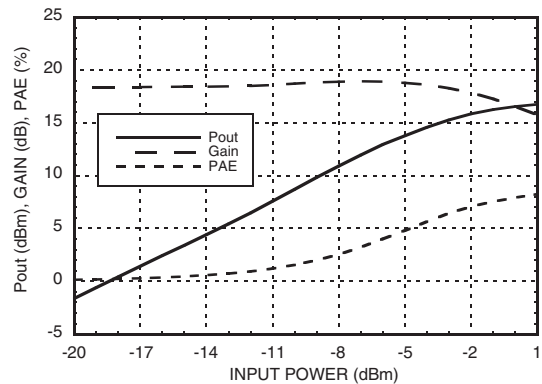

Absolute Maximum Ratings

Collector Bias Voltage (Vcc)	+5.5 Vdc
RF Input Power (RFIN)	+15 dBm
Junction Temperature	150 °C
Continuous P _{diss} (T = 85 °C) (derate 10.22 mW/°C above 85 °C)	0.66 W
Thermal Resistance (junction to lead)	97.83 °C/W
Storage Temperature	-65 to +150 °C
Operating Temperature	-40 to +85 °C
ESD Sensitivity (HMB)	Class 1C



ELECTROSTATIC SENSITIVE DEVICE
OBSERVE HANDLING PRECAUTIONS

Outline Drawing

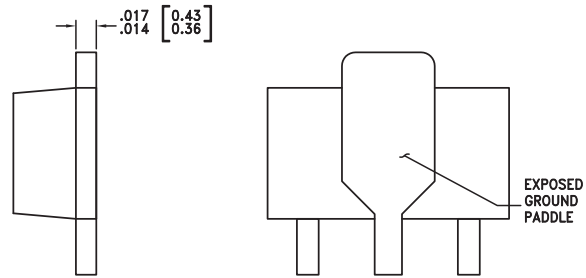
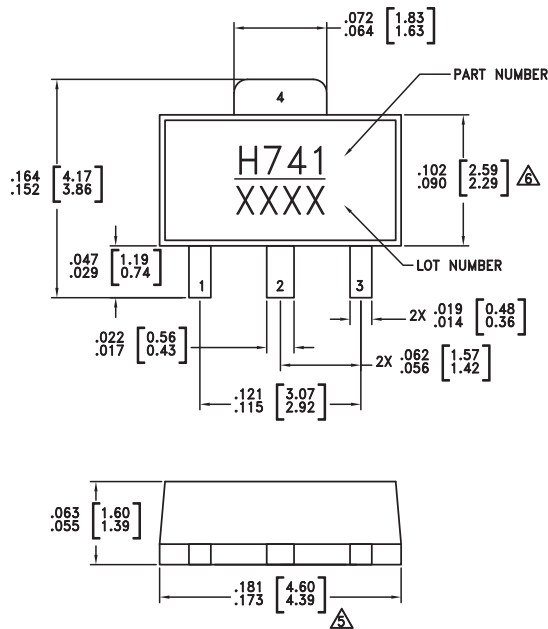

NOTES:

- PACKAGE BODY MATERIAL:
MOLDING COMPOUND MP-180S OR EQUIVALENT.
- LEAD MATERIAL: Cu w/ Ag SPOT PLATING.
- LEAD PLATING: 100% MATTE TIN.
- DIMENSIONS ARE IN INCHES [MILLIMETERS]
- Δ DIMENSION DOES NOT INCLUDE MOLDFLASH OF 0.15mm PER SIDE.
- ∇ DIMENSION DOES NOT INCLUDE MOLDFLASH OF 0.25mm PER SIDE.
- ALL GROUND LEADS MUST BE SOLDERED TO PCB RF GROUND.



Package Information

Part Number	Package Body Material	Lead Finish	MSL Rating	Package Marking ^[1]
HMC741ST89E	RoHS-compliant Low Stress Injection Molded Plastic	100% matte Sn	MSL1 ^[2]	H741 XXXX

[1] 4-Digit lot number XXXX

[2] Max peak reflow temperature of 260 °C

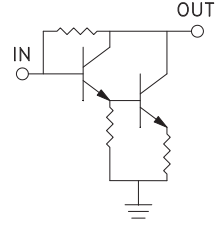
Pin Descriptions

Pin Number	Function	Description	Interface Schematic
1	IN	This pin is DC coupled. An off chip DC blocking capacitor is required.	
3	OUT	RF output and DC Bias (Vcc) for the output stage.	
2, 4	GND	These pins and package bottom must be connected to RF/DC ground.	

Application Circuit

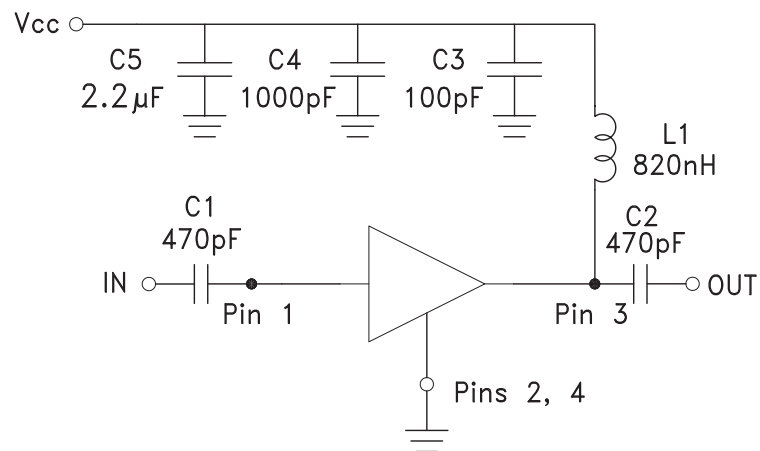

Evaluation PCB

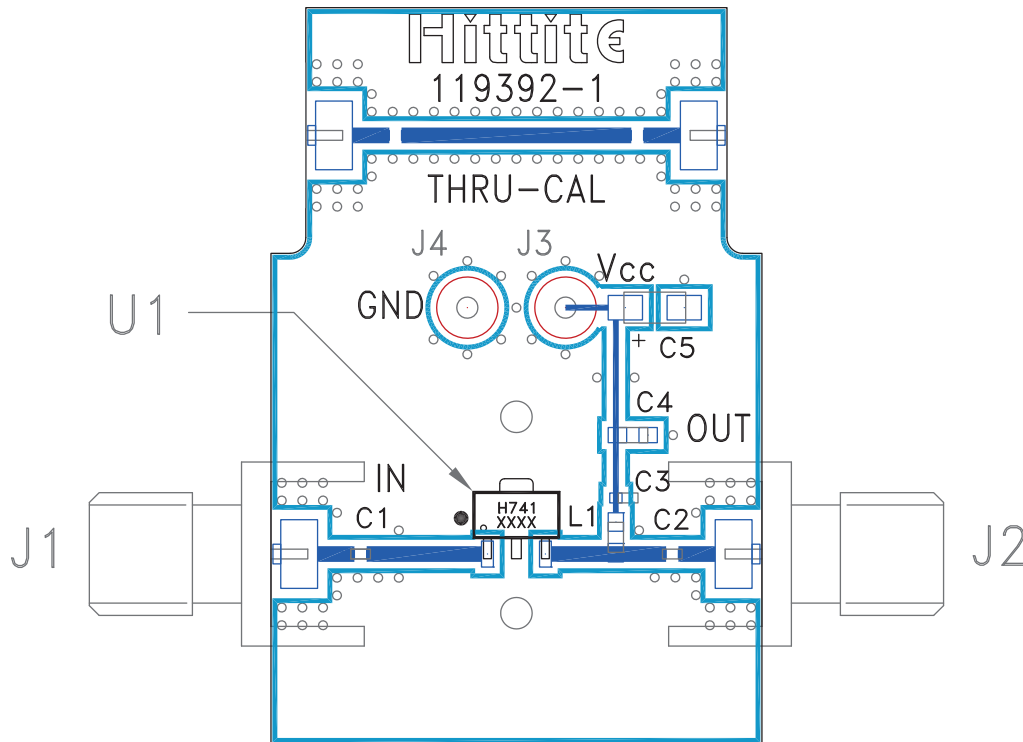

List of Materials for Evaluation PCB 124390 [1]

Item	Description
J1, J2	PCB Mount SMA Connector
J3, J4	DC Pin
C1, C2	470 pF Capacitor, 0402 Pkg.
C3	100 pF Capacitor, 0402 Pkg.
C4	1000 pF Capacitor, 0603 Pkg.
C5	2.2 μ F Capacitor Tantalum
L1	820 nH Inductor, 0603 Pkg.
U1	HMC741ST89E
PCB [2]	119392 Evaluation PCB

[1] Reference this number when ordering complete evaluation PCB

[2] Circuit Board Material: FR4

The circuit board used in the final application should use RF circuit design techniques. Signal lines should have 50 Ohm impedance while the package ground leads and package bottom should be connected directly to the ground plane similar to that shown. A sufficient number of via holes should be used to connect the top and bottom ground planes. The evaluation board should be mounted to an appropriate heat sink. The evaluation circuit board shown is available from Hittite upon request.