



PRODUCT SPECIFICATION

Model No : CSM-58211A9/58221A9

Descriptions:

- 2.3 Inch 5X8 Dot-Matrix Display
- Dot Pitch 7.62mm
- CSM-58211: Column Anode, Row Cathode
- CSM-58221: Column Cathode, Row Anode
- Emitting Color: Super Bright Amber



CUSTOMER APPROVED SIGNATURES	APPROVED BY	CHECKED BY	PREPARED BY

CHINA SEMICONDUCTOR CORPORATION
Address:2FL. NO.909,Chung-Cheng Road,
Chung-Ho City Taipei Hsien,Taiwan.

Tel:886-2-2223-9696
Fax:886-2-2223-9377

OPTO PLUS TECHNOLOGIES CO.,LTD
Address:696 Shun jiang Rd.,Ji Shan St.Shaoxing,
ZheJiang,China

Tel:86-0575-8623888
Fax:86-0575-8623112



Model No : CSM-58211/58221A9

Features -

1. 2.3 inch (58.34mm) Matrix height.
2. Case mold type.
3. RoHs compliant.
4. Low power consumption.
5. Easy mounting on P.C. board or socket.

Device Selection Guide -

Part No.	Chip		Column	Row
	Material	Emitted Color		
CSM-58211A9	AlGaInP	Super Bright Amber	Anode	Cathode
CSM-58221A9	AlGaInP	Super Bright Amber	Cathode	Anode

Package Dimensions -

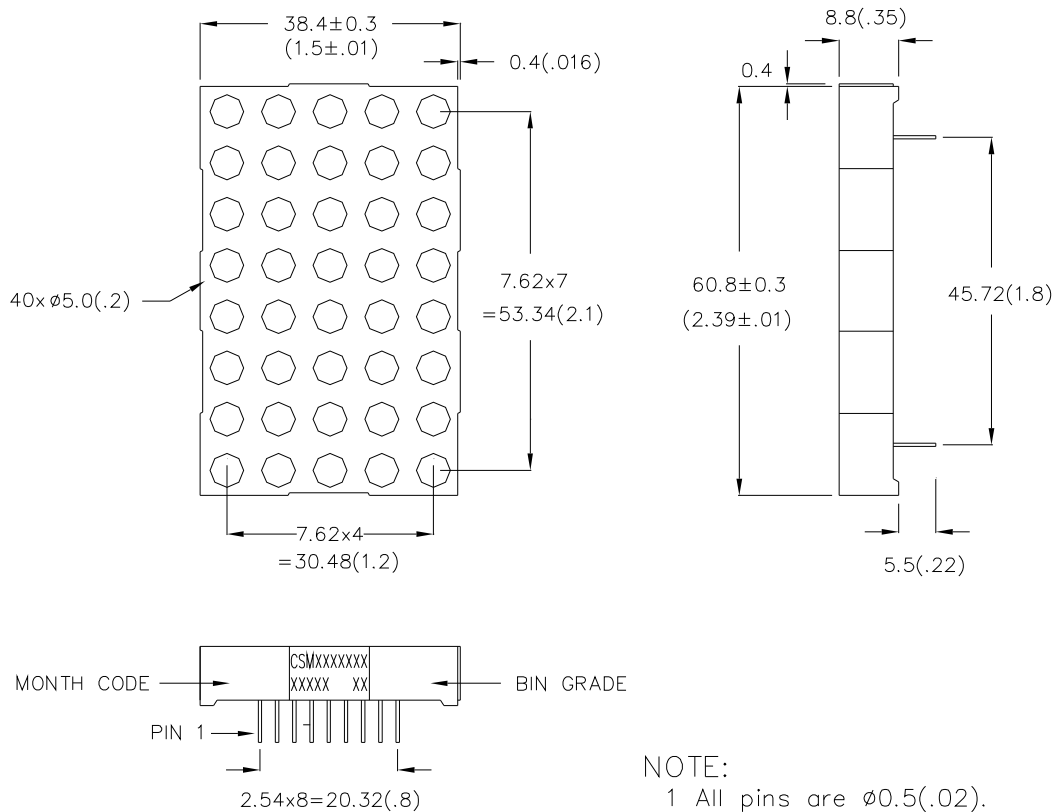

NOTE:

- 1 All pins are $\phi 0.5$ (.02).
- 2 Dimension in millimeters (inch), tolerance is ± 0.25 (.01) unless otherwise noted.



Model No : CSM-58211/58221A9

Internal Circuit Diagrams -

CSM-58221

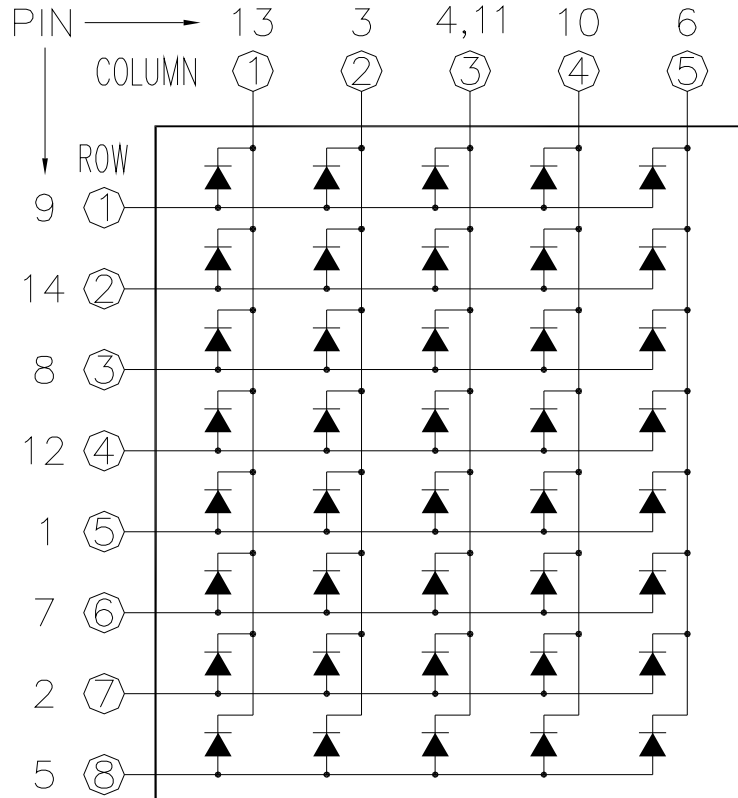

CSM-58211		CSM-58221		CSM-58221	
PIN NO.	FUNCTION	PIN NO.	FUNCTION	PIN NO.	FUNCTION
1	Cathode Row 5	8	Cathode Row 3	1	Anode Row 5
2	Cathode Row 7	9	Cathode Row 1	2	Anode Row 7
3	Anode Column 2	10	Anode Column 4	3	Cathode Column 2
4	Anode Column 3	11	Anode Column 3	4	Cathode Column 3
5	Cathode Row 8	12	Cathode Row 4	5	Anode Row 8
6	Anode Column 5	13	Anode Column 1	6	Cathode Column 5
7	Cathode Row 6	14	Cathode Row 2	7	Anode Row 6
				8	Anode Row 3
				9	Anode Row 1
				10	Cathode Column 4
				11	Cathode Column 3
				12	Anode Row 4
				13	Cathode Column 1
				14	Anode Row 2



Model No : CSM-58211/58221A9

■ Absolute Maximum Rating -

(Ta=25°C)

Parameter	Symbol	Rating	Unit
Power Dissipation Per Dice	Pd	70	mW
Continuous Forward Current Per Dice	IAF	25	mA
Peak Current Per Dice(duty cycle 1/10, 1kHz)	IPF	90	mA
Derating Linear From 25°C Per Dice	-	0.33	mA/°C
Reverse Voltage Per Dice	VR	5	V
Operating Temp.	Topr	-35 ~ +85	°C
Storage Temp.	Tstg	-35 ~ +85	°C
Solder temperature 1/16 inch below seating plane for 3 seconds at 260°C			

■ Electro-optical Characteristics -

(Ta=25°C)

Parameter	Symbol	Min.	Typ.	Max.	Unit	Condition
Forward Voltage Per Segment	VF	-	2.0	2.8	V	IF=20mA
Luminous Intensity Per Segment	Iv	-	45	-	mcd	IF=10mA
Peak Emission Wavelength	λ_p	-	612	-	nm	IF=20mA
Dominant Wavelength	λ_d	-	606	-	nm	IF=20mA
Spectrum Radiation Bandwidth	$\Delta \lambda$	-	20	-	nm	IF=20mA
Reverse Current	IR	-	-	100	μA	VR=5V
Luminous Intensity Matching Ratio	IV-m	-	-	2:1		IF=10mA



Model No : CSM-58211/58221A9

■ Typical Electrical / Optical Characteristics Curves -

(Ta = 25°C Unless Otherwise Noted)

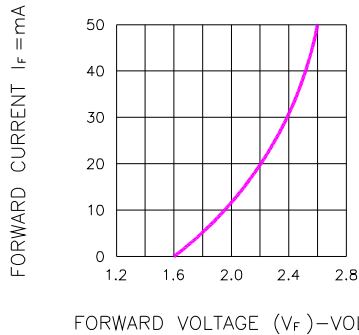

Fig.1 FORWARD CURRENT VS. FORWARD VOLTAGE

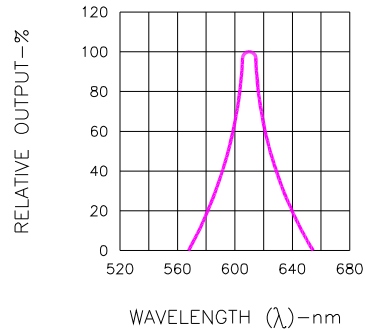

Fig.2 SPECTRAL RESPONSE

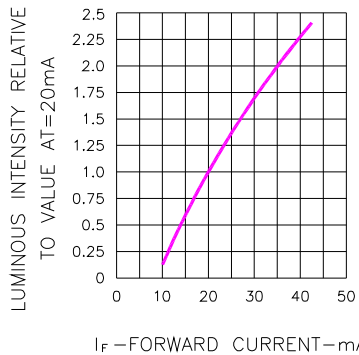

Fig.3 RELATIVE LUMINOUS INTENSITY VS. FORWARD CURRENT

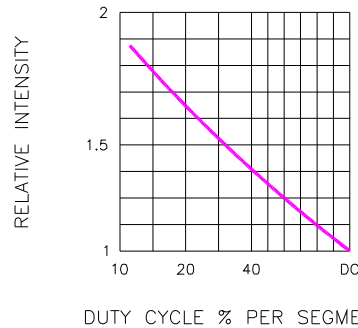

Fig.5 LUMINOUS INTENSITY VS. DUTY CYCLE

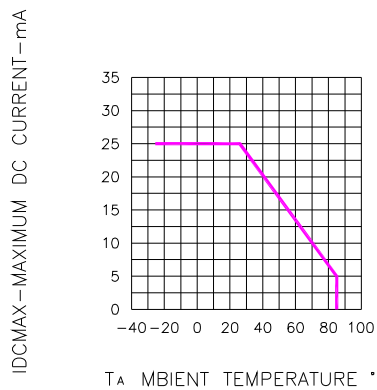

Fig.4 MAXIMUM ALLOWABLE DC CURRENT PER SEGMENT VS. A FUNCTION OF AMBIENT TEMPERATURE

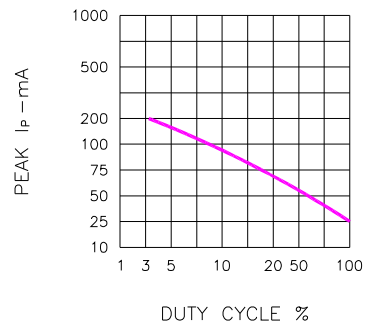

Fig.6 MAX PEAK CURRENT VS. DUTY CYCLE % (REFRESH RATE f=1 KHz)