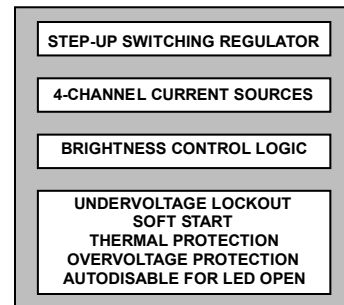

FEATURES**White LED driver based on inductive boost converter****Input voltage range: 2.8 V to 18 V****Internal compensation****1 MHz fixed operating frequency****28 V fixed overvoltage protection****Built-in soft start for boost converter****Drives up to 4 LED current sources****LED current adjustable up to 25 mA for each channel****DC current level brightness control with PWM input****LED open fault protection****General****Thermal shutdown****Undervoltage lockout****12-lead, 3 mm × 3 mm × 0.75 mm LFCSP package****APPLICATIONS****Smart PCs, PMPs, tablet PCs, UMPCs, and notebooks****GENERAL DESCRIPTION**

The [ADD5205](#) is a white LED driver for backlight applications based on high efficiency, current mode, step-up converter technology. It is designed with a 0.3 Ω internal switch and 1 MHz fixed operating frequency. The [ADD5205](#) contains four regulated constant current sources for uniform brightness intensity. Each current source is capable of driving up to 25 mA.

The [ADD5205](#) has four parallel strings of multiple series connected LEDs with $\pm 2\%$ current matching. The device provides adjustable current sources that drive up to 25 mA using an external resistor. The LED current can be controlled by a PWM signal input on the PWM pin. An internal circuit translates the PWM signal to an analog signal with an external capacitor and linearly controls the LED current.

FUNCTIONAL BLOCK DIAGRAM*Figure 1.*

The [ADD5205](#) has multiple safety protection features to prevent any damage during fault conditions. If one or more LEDs are open, the device disables the faulty current regulator automatically.

The internal soft start prevents inrush current during startup. A thermal shutdown protection feature prevents thermal damage.

The [ADD5205](#) is available in a low profile, thermally enhanced 3 mm × 3 mm × 0.75 mm, 12-lead lead frame chip scale package (LFCSP) and is specified over the temperature range of -25°C to $+85^{\circ}\text{C}$.

Rev. 0

Information furnished by Analog Devices is believed to be accurate and reliable. However, no responsibility is assumed by Analog Devices for its use, nor for any infringements of patents or other rights of third parties that may result from its use. Specifications subject to change without notice. No license is granted by implication or otherwise under any patent or patent rights of Analog Devices. Trademarks and registered trademarks are the property of their respective owners.

TABLE OF CONTENTS

Features	1	Typical Performance Characteristics	8
Applications.....	1	Theory of Operation	10
Functional Block Diagram	1	Current Mode, Stepup Switching Regulator Operation.....	10
General Description	1	Current Source.....	10
Revision History	2	PWM Dimming Mode	10
Functional Block Diagram	3	Safety Features	10
Specifications.....	4	External Component Selection Guide.....	11
Absolute Maximum Ratings.....	6	Layout Guidelines.....	12
Thermal Resistance	6	Typical Application Circuit	13
ESD Caution.....	6	Outline Dimensions	14
Pin Configuration and Function Descriptions.....	7	Ordering Guide	14

REVISION HISTORY

8/11—Revision 0: Initial Version

FUNCTIONAL BLOCK DIAGRAM

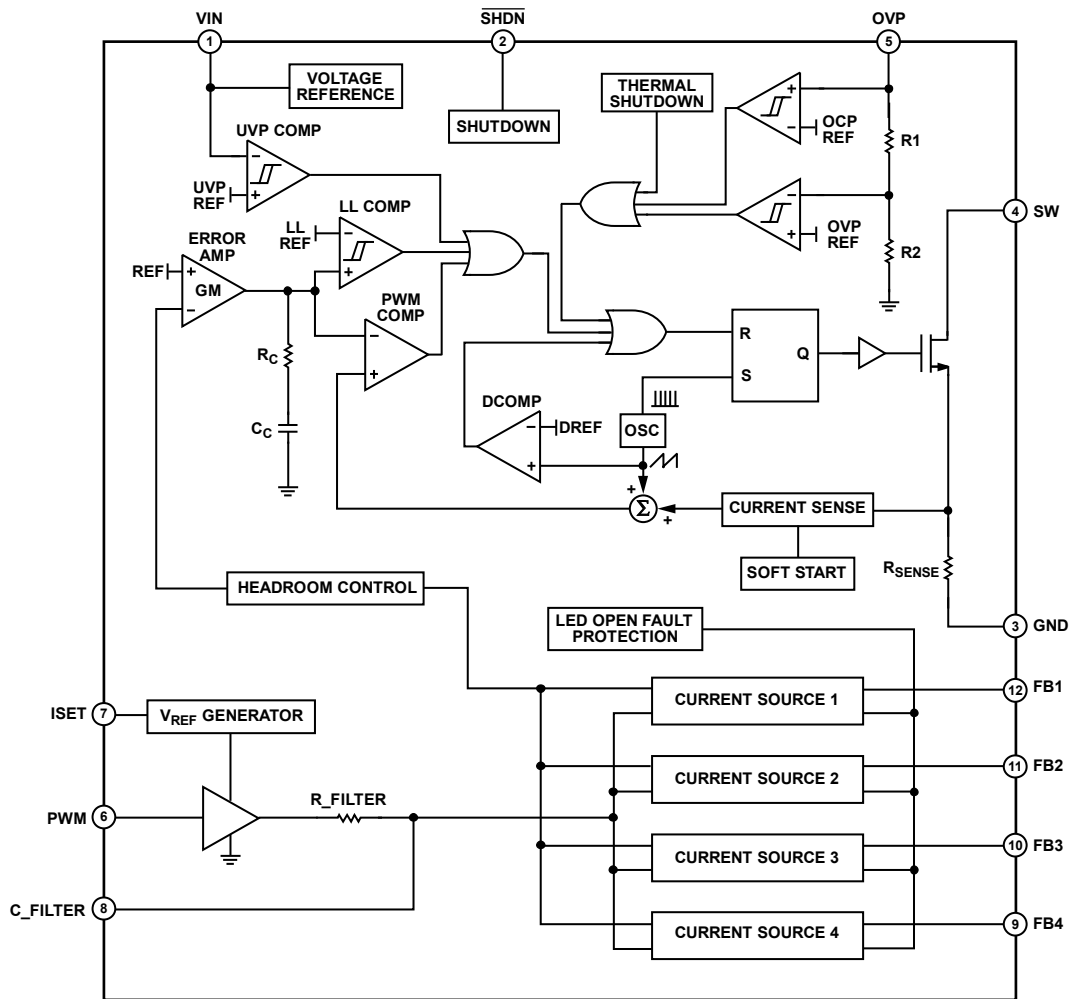

Figure 2. Functional Block Diagram

09659-003

SPECIFICATIONS

$V_{IN} = 3.7\text{ V}$, $\overline{\text{SHDN}} = \text{high}$, $T_A = -25^\circ\text{C}$ to $+85^\circ\text{C}$, unless otherwise noted. Typical values are at $T_A = 25^\circ\text{C}$.

Table 1.

Parameter	Symbol	Test Conditions/Comments	Min	Typ	Max	Unit
SUPPLY						
Input Voltage Range	V_{IN}		2.8		18	V
Quiescent Current	I_Q	$V_{IN} = 2.8\text{ V to }18\text{ V}$, not switching		3.4		mA
Shutdown Supply Current	I_{SD}	$V_{IN} = 2.8\text{ V to }18\text{ V}$, $\overline{\text{SHDN}} = 0\text{ V}$			1	μA
SWITCH						
On Resistance	$R_{DS(ON)}$	$I_{SW} = 100\text{ mA}$		0.3		Ω
Switch Current Limit	I_{CL}			1.9		A
Leakage Current	I_{LKG}				1	μA
OSCILLATOR						
Switching Frequency	f_{OSC}			1		MHz
Maximum Duty Cycle	D_{MAX}			90		%
SOFT START						
Soft Start Time ¹				1.5		ms
CURRENT SOURCE						
ISET Pin Voltage	V_{SET}			1.26		V
C_FILTER Pin Voltage	V_{C_FILTER}	Duty = 100%		0.22		V
Adjustable LED Current ¹	I_{LED}				25	mA
Constant Current Sink of 20 mA ²	I_{LED20}	$R_{SET} = 130\text{ k}\Omega$	19.6	20	20.6	mA
Headroom Voltage of 20 mA ²	V_{HR20}	$R_{SET} = 130\text{ k}\Omega$		0.66		V
Current Matching Between Strings ²		$I_{LED} = 20\text{ mA}$	-2		+2	%
LED Current Accuracy of 20 mA ²		$I_{LED} = 20\text{ mA}$	-3		+3	%
Current Source Leakage Current					1	μA
SHUTDOWN CONTROL						
$\overline{\text{SHDN}}$ Voltage High	$V_{\overline{\text{SHDN_HIGH}}}$	$V_{IN} = 2.8\text{ V to }18\text{ V}$	1.5		6	V
$\overline{\text{SHDN}}$ Voltage Low	$V_{\overline{\text{SHDN_LOW}}}$	$V_{IN} = 2.8\text{ V to }18\text{ V}$			0.6	V
PWM Control						
PWM Input Frequency Range ¹			0.1			kHz
PWM Voltage High	V_{PWM_HIGH}	$V_{IN} = 2.8\text{ V to }18\text{ V}$	1.5			V
PWM Voltage Low	V_{PWM_LOW}	$V_{IN} = 2.8\text{ V to }18\text{ V}$			0.6	V

¹ Guaranteed by design.

² Tested at $T_A = 25^\circ\text{C}$.

$V_{IN} = 3.7\text{ V}$, $\overline{\text{SHDN}} = \text{high}$, $T_A = -25^\circ\text{C}$ to $+85^\circ\text{C}$, unless otherwise noted. Typical values are at $T_A = 25^\circ\text{C}$.

Table 2.

Parameter	Symbol	Test Conditions/Comments	Min	Typ	Max	Unit
THERMAL PROTECTION						
Thermal Shutdown Threshold ¹	TSD			160		$^\circ\text{C}$
Thermal Shutdown Hysteresis ¹	TSD _{HYST}			30		$^\circ\text{C}$
UVLO						
UVLO Rising Threshold	V _{UVLOR}	V _{IN} rising		2.5		V
UVLO Falling Threshold	V _{UVLOF}	V _{IN} falling		2		V
OVERVOLTAGE PROTECTION						
Overvoltage Threshold on OVP Pin	V _{OVP}		28			V

¹ Guaranteed by design.

ABSOLUTE MAXIMUM RATINGS

T_A = 25°C, unless otherwise noted.

Table 3.

Parameter	Rating
V _{IN}	−0.3 V to +20 V
SW	−0.3 V to +32 V
SHDN,	−0.3 V to +7 V
ISET, C_FILTER	−0.3 V to +3.6 V
PWM	−0.3 V to +7 V
FB1, FB2, FB3, FB4	−0.3 V to +32 V
OVP	−0.3 V to +32 V
Maximum Junction Temperature (T _J max)	150°C
Operating Temperature Range (T _A)	−25°C to +85°C
Storage Temperature Range (T _s)	−65°C to +150°C
Reflow Peak Temperature (20 sec to 40 sec)	260°C

Stresses above those listed under Absolute Maximum Ratings may cause permanent damage to the device. This is a stress rating only; functional operation of the device at these or any other conditions above those indicated in the operational section of this specification is not implied. Exposure to absolute maximum rating conditions for extended periods may affect device reliability.

THERMAL RESISTANCE

θ_{JA} is specified for the worst-case conditions, that is, a device soldered in a circuit board for surface-mount packages.

Table 4. Thermal Resistance

Package Type	θ _{JA}	θ _{JC}	Unit
12-Lead LFCSP	41.6	7.65	°C/W

ESD CAUTION



ESD (electrostatic discharge) sensitive device. Charged devices and circuit boards can discharge without detection. Although this product features patented or proprietary protection circuitry, damage may occur on devices subjected to high energy ESD. Therefore, proper ESD precautions should be taken to avoid performance degradation or loss of functionality.

PIN CONFIGURATION AND FUNCTION DESCRIPTIONS

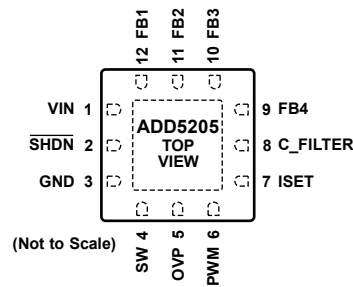

NOTES
 1. CONNECT THE EXPOSED PADDLE TO GROUND.

Figure 3. Pin Configuration

Table 5. Pin Function Descriptions

Pin No.	Mnemonic	Description
1	VIN	Supply Input Pin. Bypassed with a capacitor to ground.
2	SHDN	Shutdown Control Pin for Enabling IC. Active low.
3	GND	Ground Pin.
4	SW	Drain Connection of the Internal Power FET Pin.
5	OVP	Overvoltage Protection Sense Input Pin. Must be locally bypassed with a 100 nF capacitor and placed as close as possible to the IC.
6	PWM	PWM Signal Input Pin.
7	ISET	Full-Scale LED Current Set Pin. A resistor from this pin to ground sets the LED current up to 25 mA.
8	C_FILTER	Filtered PWM Signal Output Pin. Connect a capacitor between C_FILTER and ground. This capacitor forms a low-pass filter with an internal resistor.
9	FB4	Regulated Current Sink Input Pin. Connect the bottom cathode of the LED string to this pin. If unused, connect FB4 to ground.
10	FB3	Regulated Current Sink Input Pin. Connect the bottom cathode of the LED string to this pin. If unused, connect FB3 to ground.
11	FB2	Regulated Current Sink Input Pin. Connect the bottom cathode of the LED string to this pin. If unused, connect FB2 to ground.
12	FB1	Regulated Current Sink Input Pin. Connect the bottom cathode of the LED string to this pin. This channel should be connected to LEDs as a default channel.
	EPAD	Connect the exposed paddle to ground.

TYPICAL PERFORMANCE CHARACTERISTICS

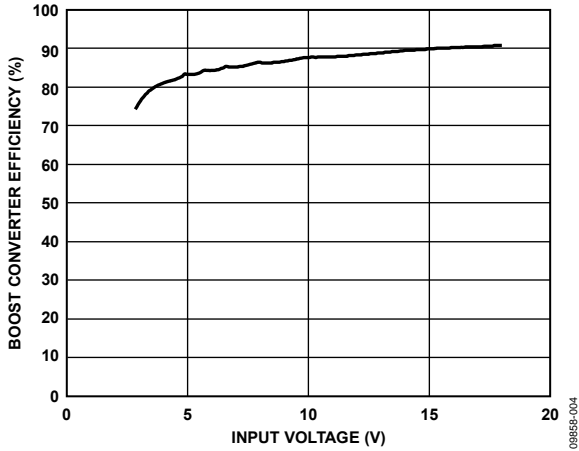

Figure 4. Boost Converter Efficiency vs. Input Voltage, $I_{LED} = 20\text{ mA}$, Brightness = 100%, and LEDs = 6 Series \times 4 Parallel

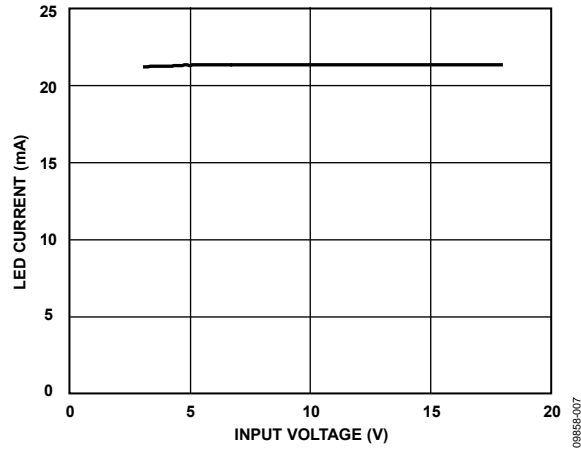

Figure 7. LED Current vs. Input Voltage ($I_{LED} = 22\text{ mA}$)

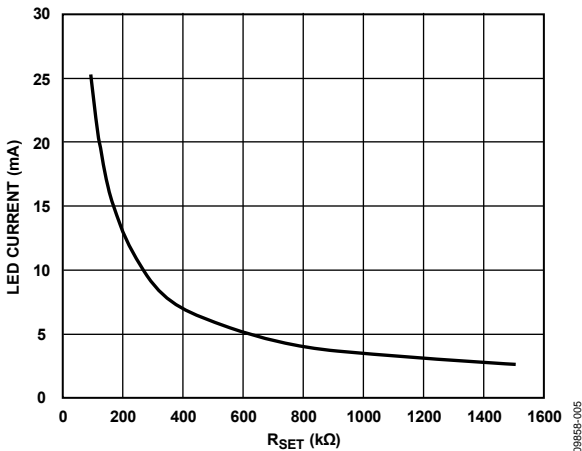

Figure 5. LED Current (I_{LED}) vs. R_{SET}

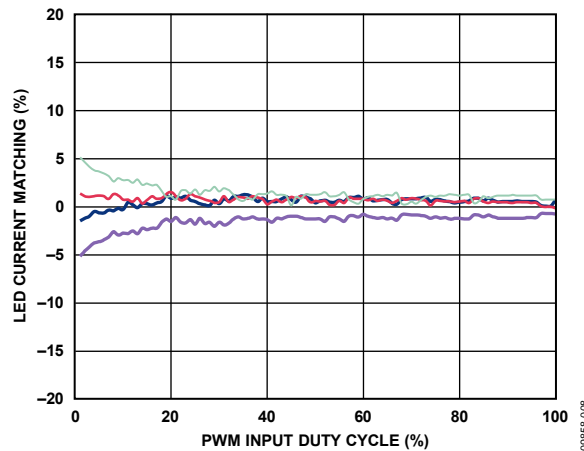

Figure 8. LED Current Matching vs. PWM Input Duty Cycle

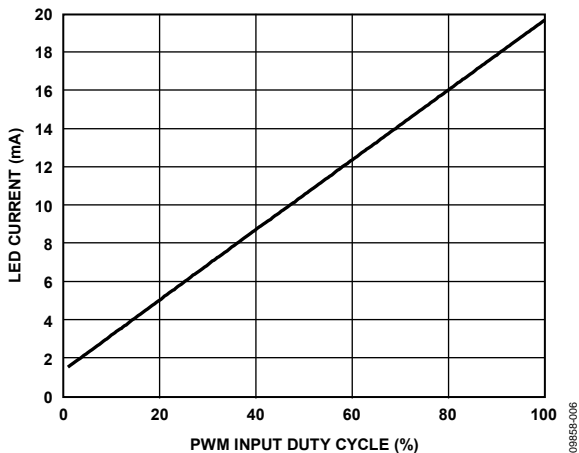

Figure 6. LED Current vs. PWM Input Duty Cycle

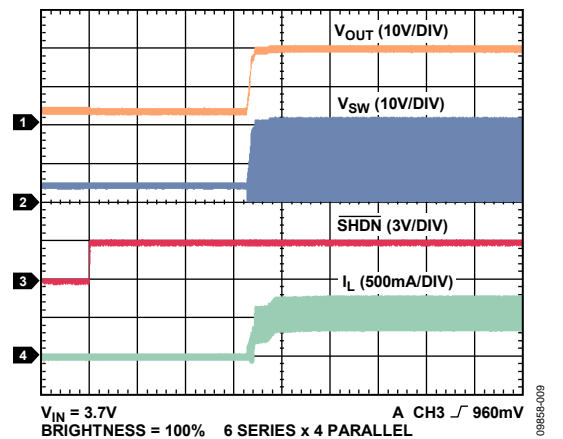

Figure 9. Start-Up Waveforms (Brightness = 100%)

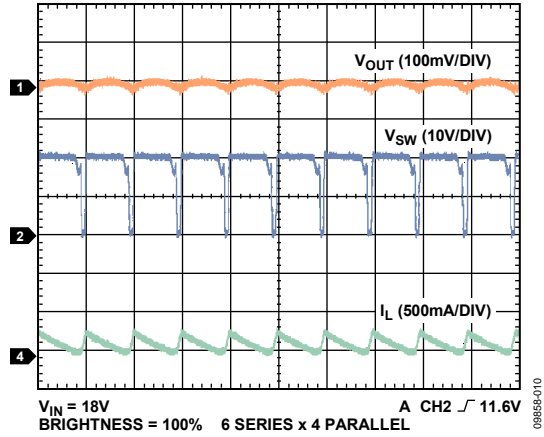

Figure 10. Switching Waveforms ($V_{IN} = 18\text{ V}$)

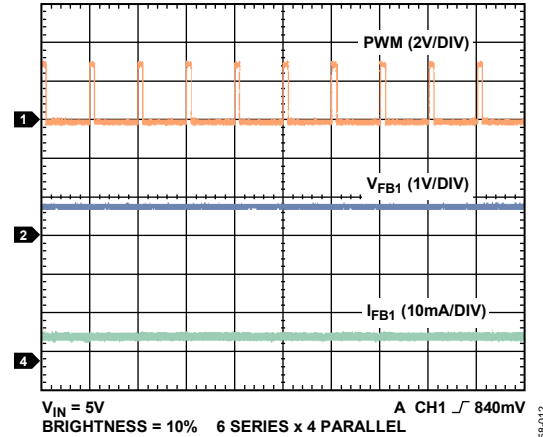

Figure 12. LED Current Waveforms (Brightness = 10%)

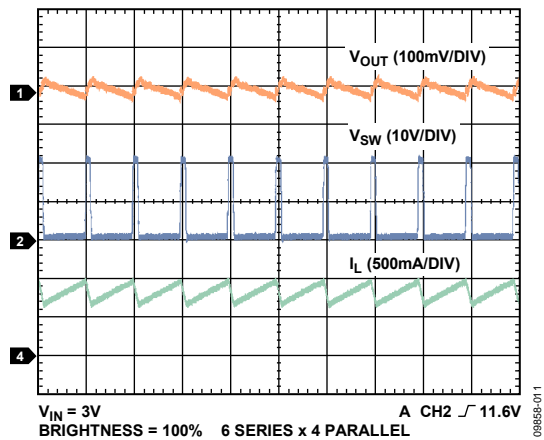

Figure 11. Switching Waveforms ($V_{IN} = 3\text{ V}$)

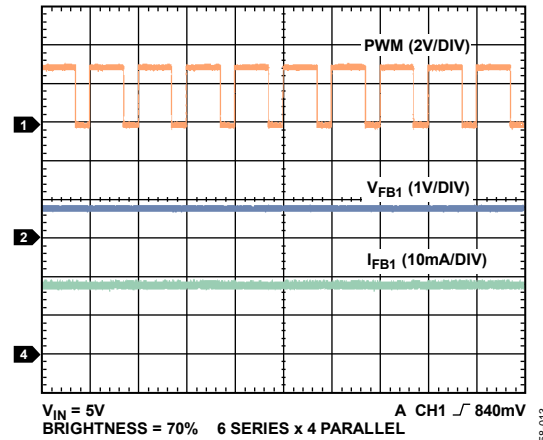

Figure 13. LED FB1 Waveforms (Brightness = 70%)

THEORY OF OPERATION

CURRENT MODE, STEPUP SWITCHING REGULATOR OPERATION

The **ADD5205** uses a current mode PWM boost regulator to provide the minimal voltage needed to enable the LED string at the programmed LED current. The current mode regulation system allows fast transient response while maintaining a stable output voltage. The regulator response can be optimized for a wide range of input voltages, output voltages, and load conditions. The **ADD5205** can provide a 28 V fixed overvoltage protection voltage and drive up to 6 LEDs (3.4 V/20 mA type of LEDs) for four channels from a supply of 3 V or up to 7 LEDs (3.4 V/20 mA type of LEDs) for four channels from a supply of 5 V to 18 V.

CURRENT SOURCE

The **ADD5205** contains four current sources to provide accurate current sinking for each LED string. String-to-string tolerance is kept within $\pm 2\%$ at 20 mA. Each LED string current is adjusted up to 25 mA by an external resistor.

The **ADD5205** contains an LED open fault protection circuit for each channel. The **ADD5205** recognizes that the current source has an open load fault for the current source, and the current source is disabled.

Programming the LED Current

As shown in Figure 2, the **ADD5205** has an LED current set pin (ISET). A resistor (R_{SET}) from this pin to ground adjusts the LED current up to 25 mA (see Figure 15). LED current level can be set by

$$I_{LED} = \frac{2600}{R_{SET}} (A)$$

PWM DIMMING MODE

The **ADD5205** supports PWM input. The internal resistor and external capacitor change the PWM input duty to analog level, and the low-pass filter output adjusts each current source sink current level.

DC Current Dimming

In this mode, the maximum LED current is set by the value of R_{SET} . Once the maximum LED current is set, the LED current can be changed through PWM input.

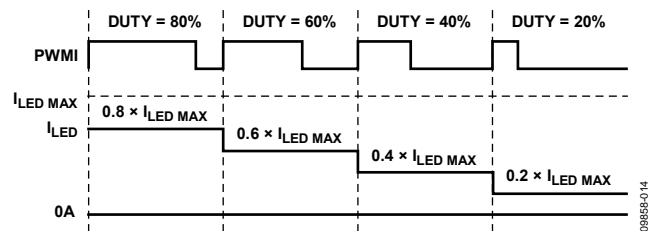

Figure 14. DC Current Dimming Timing

SAFETY FEATURES

The **ADD5205** contains several safety features to provide stable operation, such as soft start, open load protection (OLP), under-voltage lockout (UVLO), and thermal protection.

Soft Start

The **ADD5205** contains an internal soft start function to reduce inrush current at startup. The soft start time is typically 1.5 ms.

OLP

The **ADD5205** contains a headroom control circuit to minimize power loss at each current source. Therefore, the minimum feedback voltage is achieved by regulating the output voltage of the boost converter. If any LED string is open during normal operation, the current source headroom voltage (V_{HR}) is pulled to GND. In this condition, OLP is activated.

UVLO

An undervoltage lockout circuit is included with built-in hysteresis. The **ADD5205** turns on when V_{IN} rises above 2.5 V (typical) and shuts down when V_{IN} falls below 2 V (typical).

Thermal Protection

Thermal overload protection prevents excessive power dissipation from overheating the **ADD5205**. When the junction temperature (T_J) exceeds 160°C, a thermal sensor immediately activates the fault protection, which shuts down the device, allowing the IC to cool. The device self starts when the T_J of the die falls below 130°C.

EXTERNAL COMPONENT SELECTION GUIDE

Inductor Selection

The inductor is an integral part of the step-up converter. It stores energy during the switch-on time and transfers that energy to the output through the output diode during the switch-off time. An inductor in the 3.3 μH to 6.8 μH range is recommended. In general, lower inductance values result in higher saturation current and lower series resistance for a given physical size.

The input (V_{IN}) and output (V_{OUT}) voltages determine the switch duty cycle (D), which in turn can be used to determine the inductor ripple current.

$$D = \frac{V_{OUT} - V_{IN}}{V_{OUT}}$$

Use the duty cycle and switching frequency (f_{SW}) to determine the on time (t_{ON}).

$$t_{ON} = \frac{D}{f_{SW}}$$

The inductor ripple current (ΔI_L) in a steady state is

$$\Delta I_L = \frac{V_{IN} \times t_{ON}}{L}$$

Solve for the inductance value (L).

$$L = \frac{V_{IN} \times t_{ON}}{\Delta I_L}$$

Ensure that the peak inductor current (that is, the maximum input current plus half of the inductor ripple current) is less than the rated saturation current of the inductor. In addition, ensure that the maximum rated rms current of the inductor is greater than the maximum dc input current to the regulator.

$$I_{LPK} = I_{LAVG} + \frac{1}{2} \Delta I_L,$$

$$I_{LAVG} = \frac{I_{OUT} \times V_{OUT}}{\eta \times V_{IN}}$$

$$\Delta I_L = \frac{1}{L} V_{IN} \frac{V_{OUT} - V_{IN}}{f_{SW} \times V_{OUT}}$$

where:

I_{LPK} is the peak inductor current.

I_{LAVG} is the input average current.

Table 6 shows a list of recommend inductors.

Table 6. Recommended Inductors

Coilcraft Part No.	L (μH)	ISAT (A)	Size (mm)
XFL4020-332ML	3.3	2.7	4 × 4 × 2
LPS4012-472ML	4.7	1.6	3.9 × 3.9 × 1.1
LPS4018-472ML	4.7	1.8	3.9 × 3.9 × 1.7
LPS4018-682ML	6.8	1.2	3.9 × 3.9 × 1.7

Input and Output Capacitors Selection

The [ADD5205](#) requires input and output bypass capacitors to supply transient currents while maintaining a constant input and output voltage. Use a low effective series resistance (ESR) 4.7 μF or greater capacitor for the input capacitor to prevent noise at the [ADD5205](#) input. Place the input between V_{IN} and GND, as close as possible to the [ADD5205](#).

The output capacitor maintains the output voltage and supplies current to the load while the [ADD5205](#) switch is on. The value and characteristics of the output capacitor greatly affect the output voltage ripple and stability of the regulator. Use a ceramic X5R or X7R dielectric capacitor, and for the output capacitor, a 4.7 μF or greater capacitor is preferred.

Place a 100 nF or greater capacitor as close as possible to the OVP pin of [ADD5205](#).

Diode Selection

The output diode conducts the inductor current to the output capacitor and loads while the switch is off. For high efficiency, minimize the forward voltage drop of the diode. Schottky diodes are recommended.

The output diode for a boost regulator must be chosen depending on the output voltage and the output current. The diode must be rated for a reverse voltage greater than the output voltage used. The average current rating must be greater than the maximum load current expected, and the peak current rating must be greater than the peak inductor current.

LAYOUT GUIDELINES

When designing a high frequency, switching, regulated power supply, layout is very important. Using a good layout can solve many problems associated with these types of supplies. The main problems are loss of regulation at high output current and/or large input-to-output voltage differentials, excessive noise on the output and switch waveforms, and instability. Using the following guidelines can help minimize these problems.

Make all power (high current) traces as short, direct, and thick as possible. It is good practice on a standard printed circuit board (PCB) to make the traces an absolute minimum of 15 mil (0.381 mm) per ampere. Place the inductor, output capacitors, and output diode as close to each other as possible. This helps reduce the EMI radiated by the power traces that is due to the high switching currents through them. This also reduces lead inductance and resistance, which in turn reduces noise spikes, ringing, and resistive losses that produce voltage errors.

The grounds of the IC, input capacitors, output capacitors, and output diode (if applicable), should be connected close together, directly to a ground plane. It is also a good idea to have a ground plane on both sides of the PCB. This reduces noise by reducing ground loop errors and by absorbing more of the EMI radiated by the inductor.

Due to how switching regulators operate, there are two power states: on and off. During each state, there is a current loop made by the power components currently conducting. Place the power components so that the current loop is conducting in the same direction during each of the two states. This prevents magnetic field reversal caused by the traces between the two half cycles and reduces radiated EMI.

Layout Procedure

Use the following general guidelines when designing PCBs:

- Keep C_{IN} close to the VIN and GND leads of the ADD5205.
- Keep the high current path from C_{IN} (through L1) to the SW and GND leads as short as possible.
- Keep the high current path from C_{IN} (through L1), D1, and C_{OUT} as short as possible.
- Keep high current traces as short and wide as possible.
- Place the C_{OVP} as close as possible to the OVP pin.
- Place the LED current setting resistors as close as possible to each pin to prevent noise pickup.
- Avoid routing noise sensitive traces near high current traces and components, especially the LED current setting node (ISET).
- Use a thermal pad size that is the same dimension as the exposed pad on the bottom of the package.

Heat Sinking

When using a surface-mount power IC or external power switches, the PCB can often be used as the heat sink. This is done by using the copper area of the PCB to transfer heat from the device. Users should maximize this area to optimize thermal performance.

TYPICAL APPLICATION CIRCUIT

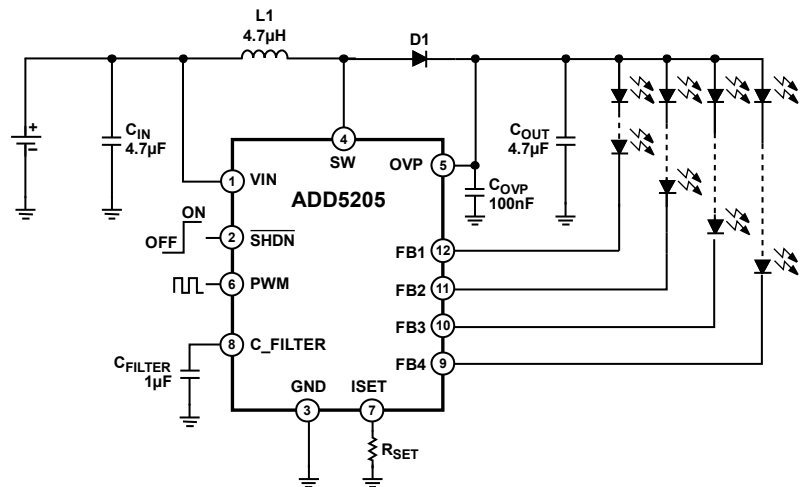
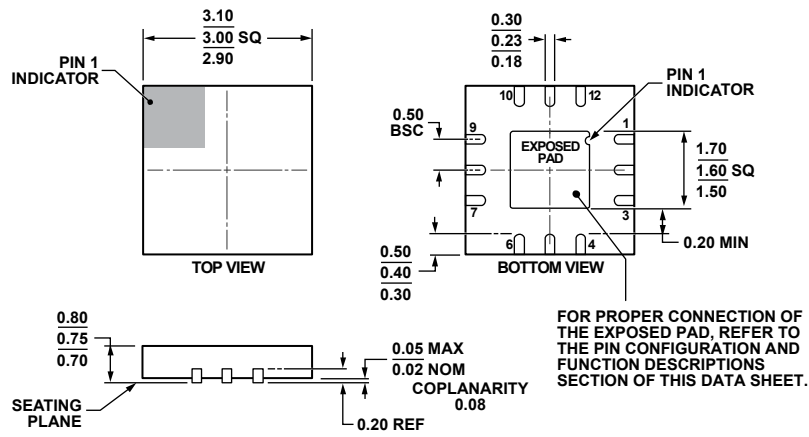

Figure 15. Typical Application Circuit

09899-015

OUTLINE DIMENSIONS



COMPLIANT TO JEDEC STANDARDS MO-229-WEED-4.

Figure 16. 12-Lead Lead Frame Chip Scale Package [LFCSP_WQ]
 3 mm × 3 mm Body, Very Very Thin Quad
 (CP-12-6)
 Dimensions shown in millimeters

072809-B

ORDERING GUIDE

Model ¹	Temperature Range	Package Description	Package Option
ADD5205ACPZ-RL	-25°C to +85°C	12-Lead Lead Frame Chip Scale Package [LFCSP_WQ]	CP-12-6

¹ Z = RoHS Compliant Part.

NOTES

NOTES