

**ADVANCED
POWER
TECHNOLOGY®**

APT5012JNU3 500V 43A 0.12Ω

POWER MOS IV®

Single Die MOSFET and UltraFast Diode For "PFC Buck Circuits"

N-CHANNEL ENHANCEMENT MODE HIGH VOLTAGE POWER MOSFETS

MAXIMUM RATINGS

All Ratings: $T_C = 25^\circ\text{C}$ unless otherwise specified.

Symbol	Parameter	APT 5012JNU3	UNIT
V_{DSS}	Drain-Source Voltage	500	Volts
I_D	Continuous Drain Current @ $T_C = 25^\circ\text{C}$	43	Amps
I_{DM}, I_{LM}	Pulsed Drain Current ^① and Inductive Current Clamped	172	
V_{GS}	Gate-Source Voltage	± 30	Volts
P_D	Total Power Dissipation @ $T_C = 25^\circ\text{C}$	520	Watts
	Linear Derating Factor	4.16	W/ $^\circ\text{C}$
T_J, T_{STG}	Operating and Storage Junction Temperature Range	-55 to 150	$^\circ\text{C}$
T_L	Lead Temperature: 0.063" from Case for 10 Sec.	300	

STATIC ELECTRICAL CHARACTERISTICS

Symbol	Characteristic / Test Conditions / Part Number	MIN	TYP	MAX	UNIT
BV_{DSS}	Drain-Source Breakdown Voltage ($V_{GS} = 0V, I_D = 250 \mu\text{A}$)	APT5012JNU3	500		Volts
$I_{D(ON)}$	On State Drain Current ^② ($V_{DS} > I_{D(ON)} \times R_{DS(ON)}$ Max, $V_{GS} = 10V$)	APT5012JNU3	43		Amps
$R_{DS(ON)}$	Drain-Source On-State Resistance ^② ($V_{GS} = 10V, 0.5 I_D$ [Cont.])	APT5012JNU3		0.12	Ohms
I_{DSS}	Zero Gate Voltage Drain Current ($V_{DS} = V_{DSS}, V_{GS} = 0V$)			250	μA
	Zero Gate Voltage Drain Current ($V_{DS} = 0.8 V_{DSS}, V_{GS} = 0V, T_C = 125^\circ\text{C}$)			1000	
I_{GSS}	Gate-Source Leakage Current ($V_{GS} = \pm 30V, V_{DS} = 0V$)			± 100	nA
$V_{GS(TH)}$	Gate Threshold Voltage ($V_{DS} = V_{GS}, I_D = 2.5\text{mA}$)	2		4	Volts

THERMAL CHARACTERISTICS

Symbol	Characteristic	MIN	TYP	MAX	UNIT
$R_{\theta JC}$	Junction to Case			0.24	$^\circ\text{C/W}$
$R_{\theta CS}$	Case to Sink (Use High Efficiency Thermal Joint Compound and Planer Heat Sink Surface.)		0.06		

CAUTION: These Devices are Sensitive to Electrostatic Discharge. Proper Handling Procedures Should Be Followed.

USA
405 S.W. Columbia Street
EUROPE

Bend, Oregon 97702-1035 Phone: (541) 382-8028 FAX: (541) 388-0364

Avenue J.F. Kennedy Bât B4 Parc Cadéra Nord F-33700 Merignac - France Phone: (33) 57 92 15 15 FAX: (33) 56 47 97 61

ISOTOP® is a Registered Trademark of SGS-Thomson.

050-5140 Rev A

DYNAMIC CHARACTERISTICS

APT5012JNU3

Symbol	Characteristic	Test Conditions	MIN	TYP	MAX	UNIT
C_{iss}	Input Capacitance	$V_{GS} = 0V$ $V_{DS} = 25V$ $f = 1\text{ MHz}$		5570	6500	pF
C_{oss}	Output Capacitance			1170	1640	
C_{rss}	Reverse Transfer Capacitance			440	660	
Q_g	Total Gate Charge ③	$V_{GS} = 10V$ $V_{DD} = 0.5 V_{DSS}$ $I_D = I_D [Cont.] @ 25^\circ C$		240	370	nC
Q_{gs}	Gate-Source Charge			32	48	
Q_{gd}	Gate-Drain ("Miller") Charge			116	170	
$t_{d(on)}$	Turn-on Delay Time	$V_{GS} = 15V$ $V_{DD} = 0.5 V_{DSS}$ $I_D = I_D [Cont.] @ 25^\circ C$ $R_G = 0.6\Omega$		15	30	ns
t_r	Rise Time			25	50	
$t_{d(off)}$	Turn-off Delay Time			48	75	
t_f	Fall Time			12	25	

SOURCE-DRAIN DIODE RATINGS AND CHARACTERISTICS

Symbol	Characteristic / Test Conditions	MIN	TYP	MAX	UNIT
I_S	Continuous Source Current (Body Diode)	APT5012JNU3		43	Amps
I_{SM}	Pulsed Source Current ① (Body Diode)	APT5012JNU3		172	
V_{SD}	Diode Forward Voltage ② ($V_{GS} = 0V, I_S = -I_D [Cont.]$)			1.8	Volts
t_{rr}	Reverse Recovery Time ($I_S = -I_D [Cont.]$, $di_S/dt = 100A/\mu s$)	210	415	830	ns
Q_{rr}	Reverse Recovery Charge ($I_S = -I_D [Cont.]$, $di_S/dt = 100A/\mu s$)	4	8.3	16	μC

PACKAGE CHARACTERISTICS

Symbol	Characteristic / Test Conditions	MIN	TYP	MAX	UNIT
L_D	Internal Drain Inductance (Measured From Drain Terminal to Center of Die.)		3		nH
L_S	Internal Source Inductance (Measured From Source Terminals to Source Bond Pads)		5		
$V_{isolation}$	RMS Voltage (50-60 Hz Sinusoidal Waveform From Terminals to Mounting Base for 1 Min.)	2500			Volts
$C_{isolation}$	Drain-to-Mounting Base Capacitance ($f = 1\text{ MHz}$)		35		pF
Torque	Maximum Torque for Device Mounting Screws and Electrical Terminations.			13	lb·in

① Repetitive Rating: Pulse width limited by maximum junction temperature. See Transient Thermal Impedance Curve. (Fig.1)

② Pulse Test: Pulse width < 380 μs , Duty Cycle < 2%

③ See MIL-STD-750 Method 3471

APT Reserves the right to change, without notice, the specifications and information contained herein.

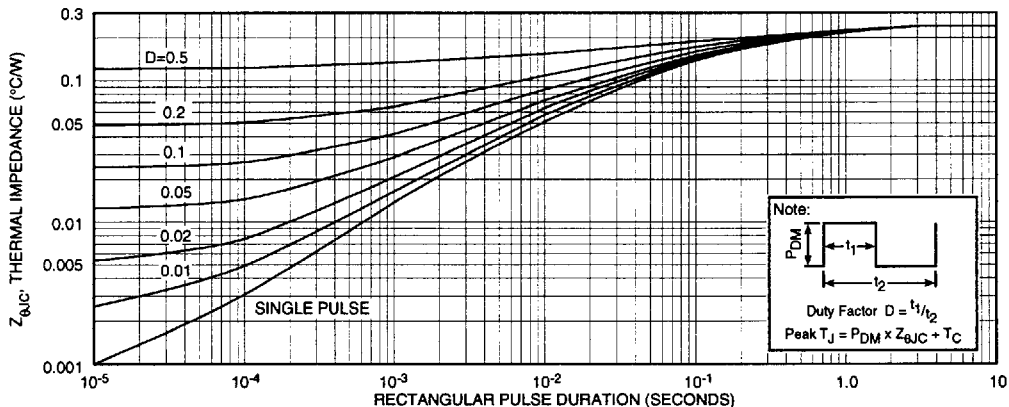

FIGURE 1, MAXIMUM EFFECTIVE TRANSIENT THERMAL IMPEDANCE, JUNCTION-TO-CASE vs PULSE DURATION

APT5012JNU3

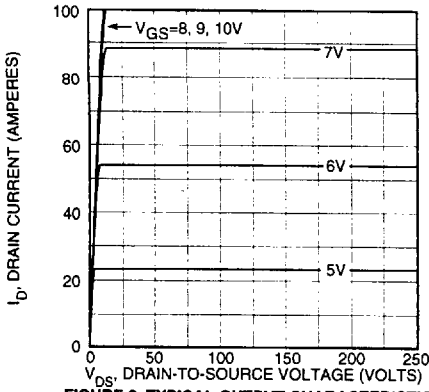

FIGURE 2, TYPICAL OUTPUT CHARACTERISTICS

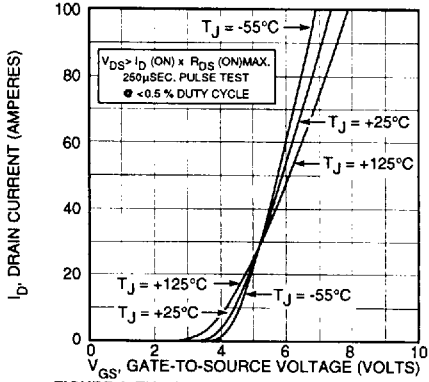

FIGURE 4, TYPICAL TRANSFER CHARACTERISTICS

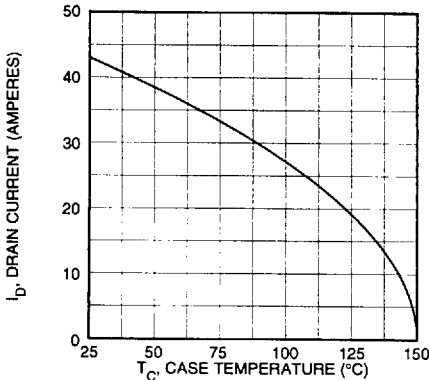

FIGURE 6, MAXIMUM DRAIN CURRENT vs CASE TEMPERATURE

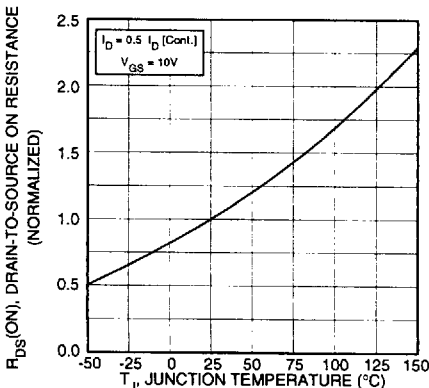

FIGURE 8, ON-RESISTANCE vs. TEMPERATURE

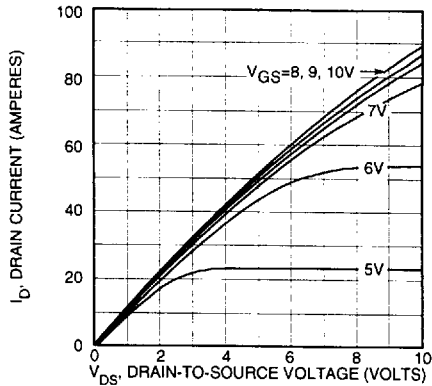

FIGURE 3, TYPICAL OUTPUT CHARACTERISTICS

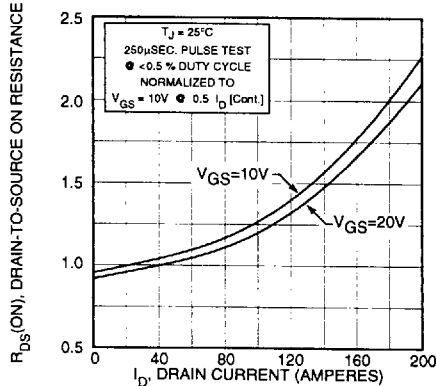

FIGURE 5, $R_{DS(ON)}$ vs DRAIN CURRENT

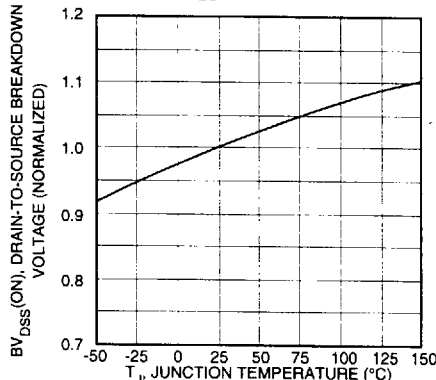

FIGURE 7, BREAKDOWN VOLTAGE vs TEMPERATURE

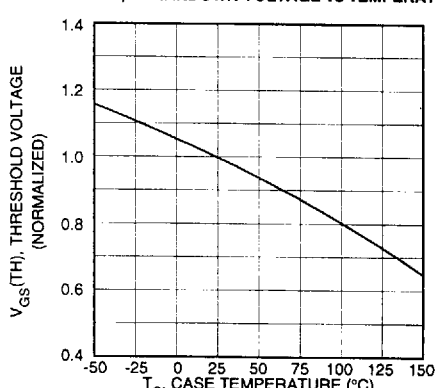

FIGURE 9, THRESHOLD VOLTAGE vs TEMPERATURE

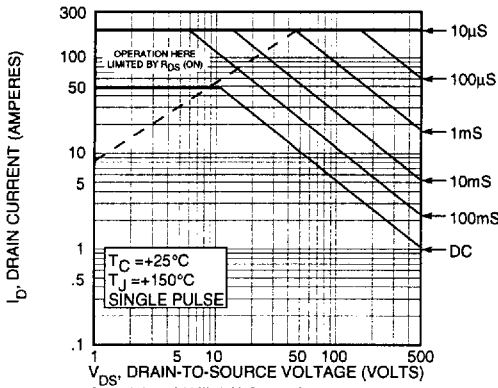

FIGURE 10, MAXIMUM SAFE OPERATING AREA

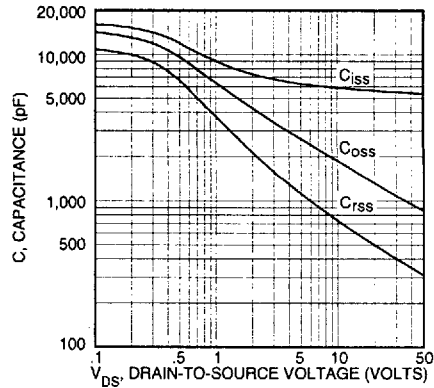

FIGURE 11, TYPICAL CAPACITANCE vs DRAIN-TO-SOURCE VOLTAGE

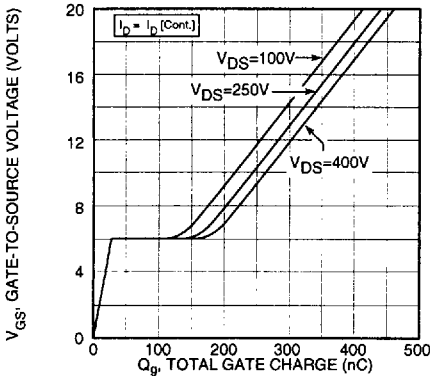

FIGURE 12, GATE CHARGES vs GATE-TO-SOURCE VOLTAGE

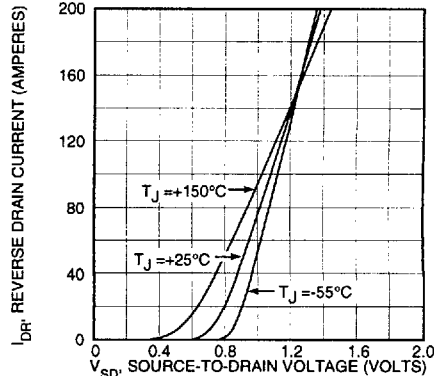

FIGURE 13, TYPICAL SOURCE-DRAIN DIODE FORWARD VOLTAGE

MAXIMUM RATINGS (UltraFast Recovery Diode)

All Ratings: $T_C = 25^\circ\text{C}$ unless otherwise specified.

Symbol	Characteristic / Test Conditions	APT5012JNU3	UNIT
V_R	Maximum D.C. Reverse Voltage		
V_{RRM}	Maximum Peak Repetitive Reverse Voltage	600	Volts
V_{RWM}	Maximum Working Peak Reverse Voltage		
$I_F(AV)$	Maximum Average Forward Current ($T_C = 100^\circ\text{C}$, Duty Cycle = 0.5)	30	
$I_F(RMS)$	RMS Forward Current	70	Amps
I_{FSM}	Non-Repetitive Forward Surge Current ($T_J = 45^\circ\text{C}$, 8.3ms)	320	
T_J, T_{STG}	Operating and Storage Temperature Range	-55 to 150	$^\circ\text{C}$
T_L	Lead Temperature: 0.063" from Case for 10 Sec.	300	

STATIC ELECTRICAL CHARACTERISTICS

Symbol	Characteristic / Test Conditions	MIN	TYP	MAX	UNIT
V_F	Maximum Forward Voltage	$I_F = 30\text{A}$		1.8	Volts
		$I_F = 60\text{A}$		1.5	
		$I_F = 30\text{A}, T_J = 150^\circ\text{C}$		1.6	
I_{RM}	Maximum Reverse Leakage Current	$V_R = V_R$ Rated		250	μA
		$V_R = V_R$ Rated, $T_J = 125^\circ\text{C}$		500	
C_T	Junction Capacitance, $V_R = 200\text{V}$		40		pF

050-5140 Rev A ISOTOP® is a Registered Trademark of SGS Thomson.

DYNAMIC CHARACTERISTICS

Symbol	Characteristic	MIN	TYP	MAX	UNIT
t_{rr1}	Reverse Recovery Time, $I_F = 1.0A$, $di_F/dt = -15A/\mu S$, $V_R = 30V$, $T_J = 25^\circ C$		50	65	nS
t_{rr2}	Reverse Recovery Time	$T_J = 25^\circ C$	50		
t_{rr3}	$I_F = 30A$, $di_F/dt = -240A/\mu S$, $V_R = 350V$	$T_J = 100^\circ C$	80		
t_{fr1}	Forward Recovery Time	$T_J = 25^\circ C$	155		Volts
t_{fr2}	$I_F = 30A$, $di_F/dt = 240A/\mu S$, $V_R = 350V$	$T_J = 100^\circ C$	155		
I_{RRM1}	Reverse Recovery Current	$T_J = 25^\circ C$	4	10	Amps
I_{RRM2}	$I_F = 30A$, $di_F/dt = -240A/\mu S$, $V_R = 350V$	$T_J = 100^\circ C$	7.5	15	
Q_{rr1}	Recovery Charge	$T_J = 25^\circ C$	100		nC
Q_{rr2}	$I_F = 30A$, $di_F/dt = -240A/\mu S$, $V_R = 350V$	$T_J = 100^\circ C$	300		
V_{fr1}	Forward Recovery Voltage	$T_J = 25^\circ C$	5		Volts
V_{fr2}	$I_F = 30A$, $di_F/dt = 240A/\mu S$, $V_R = 350V$	$T_J = 100^\circ C$	5		
diM/dt	Rate of Fall of Recovery Current	$T_J = 25^\circ C$	400		A/ μS
	$I_F = 30A$, $di_F/dt = -240A/\mu S$, $V_R = 350V$ (See Figure 10)	$T_J = 100^\circ C$	200		

THERMAL AND MECHANICAL CHARACTERISTICS

Symbol	Characteristic / Test Conditions	MIN	TYP	MAX	UNIT
$R_{\theta JC}$	Junction-to-Case Thermal Resistance			0.90	$^\circ C/W$
$R_{\theta JA}$	Junction-to-Ambient Thermal Resistance			20	
W_T	Package Weight		1.06		oz.
			30		gm.

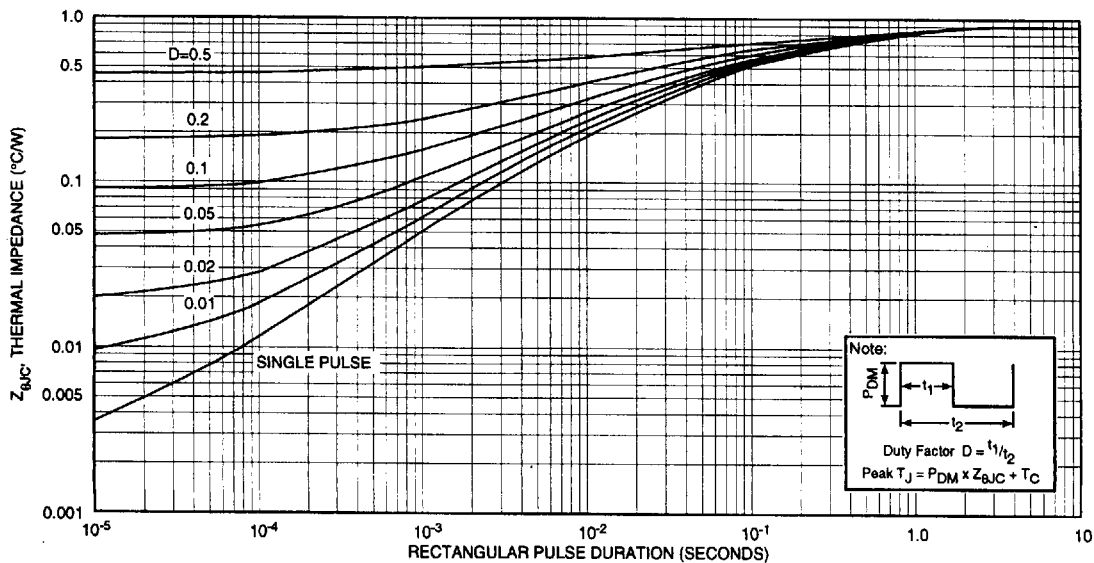

FIGURE 14. MAXIMUM EFFECTIVE TRANSIENT THERMAL IMPEDANCE, JUNCTION-TO-CASE vs PULSE DURATION

ISOTOP[®] is a Registered Trademark of SGS Thomson.
 050-5140 Rev A

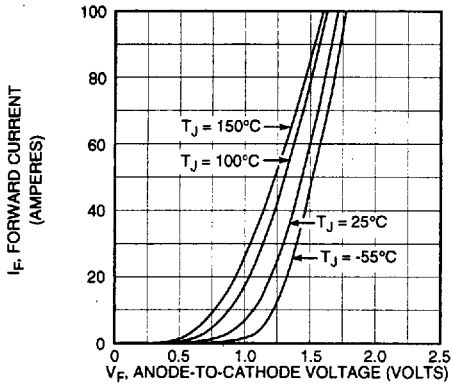

Figure 15, Forward Voltage Drop vs Forward Current

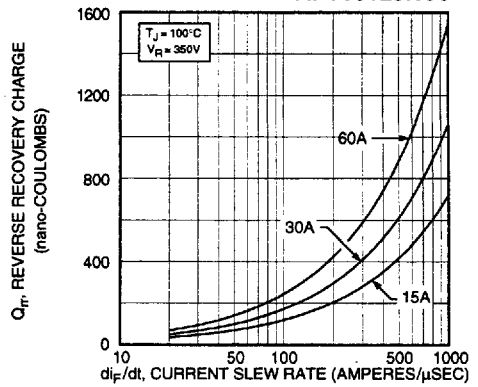

Figure 16, Reverse Recovery Charge vs Current Slew Rate

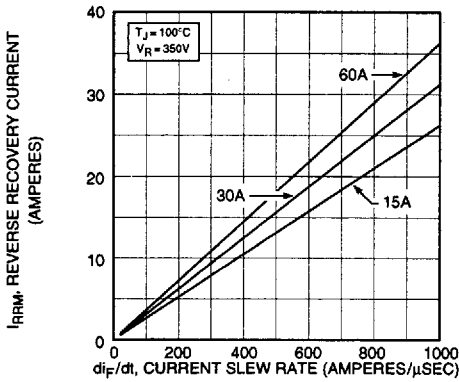

Figure 17, Reverse Recovery Current vs Current Slew Rate

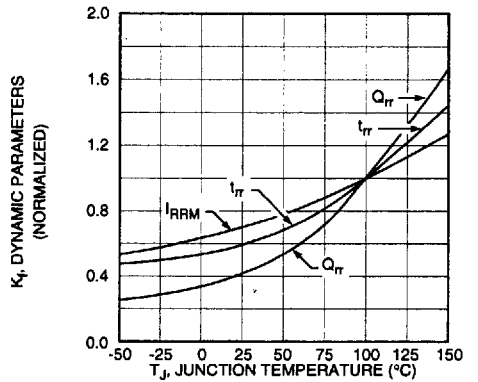

Figure 18, Dynamic Parameters vs Junction Temperature

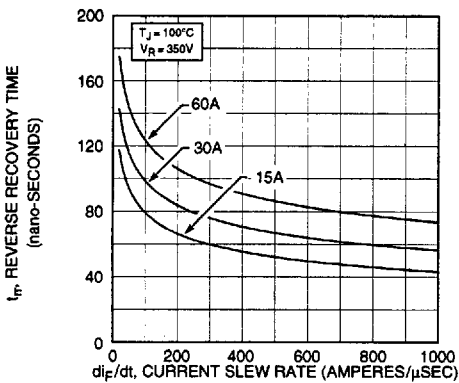

Figure 19, Reverse Recovery Time vs Current Slew Rate

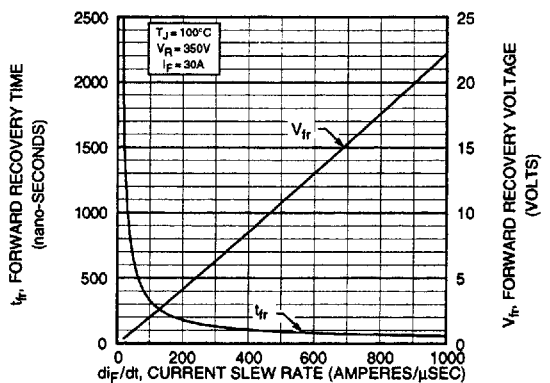

Figure 20, Forward Recovery Voltage/Time vs Current Slew Rate

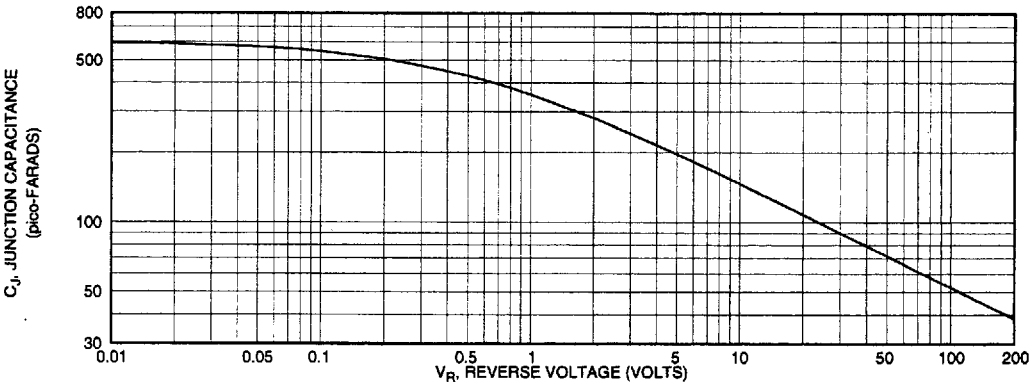

Figure 21, Junction Capacitance vs Reverse Voltage

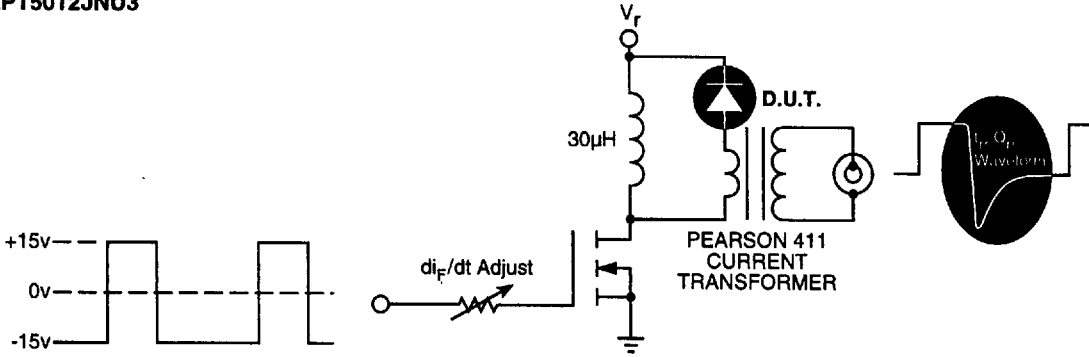
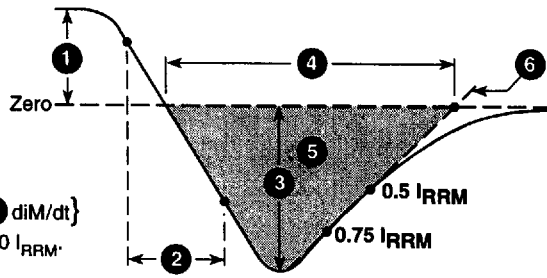

Figure 22, Diode Reverse Recovery Test Circuit and Waveforms

- 1 I_F - Forward Conduction Current
- 2 di_F/dt - Current Slew Rate, Rate of Forward Current Change Through Zero Crossing.
- 3 I_{RRM} - Peak Reverse Recovery Current.
- 4 t_{rr} - Reverse Recovery Time Measured from Point of I_F Current Falling Through Zero to a Tangent Line {6 di_M/dt } Extrapolated Through Zero Defined by 0.75 and 0.50 I_{RRM} .
- 5 Q_{rr} - Area Under the Curve Defined by I_{RRM} and t_{rr} .
- 6 di_M/dt - Maximum Rate of Current Change During the Trailing Portion of t_{rr} .



$$Q_{rr} = 1/2 (t_{rr} \cdot I_{RRM})$$

Figure 23, Diode Reverse Recovery Waveform and Definitions

SOT-227 (ISOTOP®) Package Outline

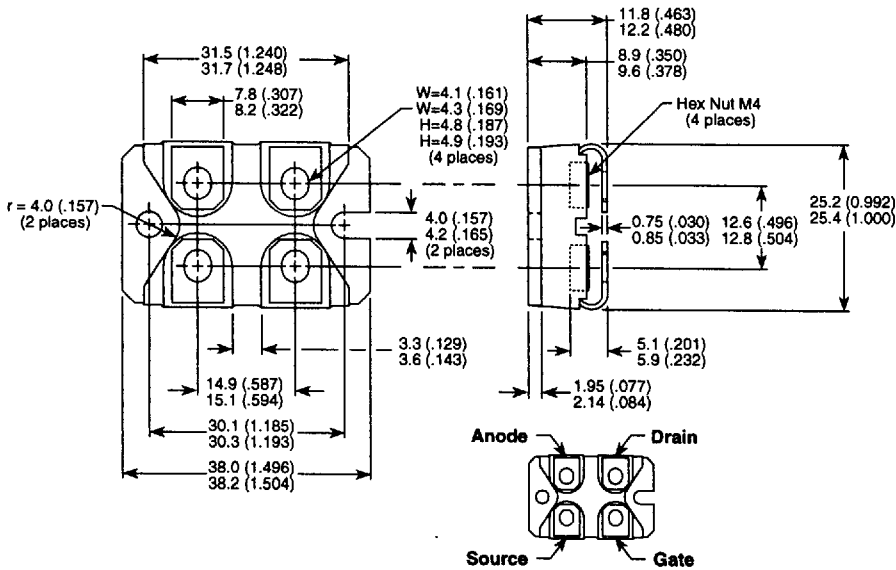

Dimensions in Millimeters and (Inches)

APT Reserves the right to change, without notice, the specifications and information contained herein.