

PLEASE CHECK WWW.MOLEX.COM FOR LATEST PART INFORMATION

Part Number: [0877583217](#)
Status: **Active**
Overview: milligrid
Description: 2.00mm (.079") Pitch Milli-Grid™ Header, Through Hole, Vertical, 32 Circuits, 0.76µm (30µ") Gold (Au) Selective Plating, Pocket Tray Packaging, Lead-free

Documents:

[3D Model](#) [Product Specification PS-87761-100 \(PDF\)](#)
[Drawing \(PDF\)](#) [RoHS Certificate of Compliance \(PDF\)](#)

Agency Certification

UL E29179

General

Product Family PCB Headers
 Series [87758](#)
 Application Board-to-Board
 Overview [milligrid](#)
 Product Name Milli-Grid™

Physical

Breakaway Yes
 Circuits (Loaded) 32
 Circuits (maximum) 32
 Color - Resin Black
 Durability (mating cycles max) 100
 First Mate / Last Break No
 Flammability 94V-0
 Glow-Wire Compliant No
 Guide to Mating Part No
 Keying to Mating Part None
 Lock to Mating Part None
 Mated Height (in) 0.157 In
 Mated Height (mm) 4.00 mm
 Material - Metal Phosphor Bronze
 Material - Plating Mating Gold
 Material - Plating Termination Tin
 Material - Resin Nylon
 Number of Rows 2
 Orientation Vertical
 PC Tail Length (in) 0.102 In
 PC Tail Length (mm) 2.60 mm
 PCB Locator No
 PCB Retention None
 PCB Thickness Recommended (in) 0.062 In
 PCB Thickness Recommended (mm) 1.60 mm
 Packaging Type Tray
 Pitch - Mating Interface (in) 0.079 In
 Pitch - Mating Interface (mm) 2.00 mm
 Pitch - Term. Interface (in) 0.079 In
 Pitch - Term. Interface (mm) 2.00 mm
 Plating min: Mating (µin) 30
 Plating min: Mating (µm) 0.76
 Polarized to Mating Part No
 Polarized to PCB No
 Shrouded No

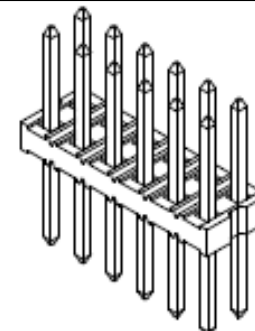

image - Reference only

Series

EU RoHS

ELV and RoHS Compliant
REACH SVHC Contains SVHC: No
Halogen-Free Status
Not Reviewed

China RoHS



Need more information on product environmental compliance?

Email productcompliance@molex.com
 For a multiple part number RoHS Certificate of Compliance, [click here](#)

Please visit the [Contact Us](#) section for any non-product compliance questions.

Search Parts in this Series

[87758Series](#)

Mates With

[79107](#) Milli-Grid™ Receptacle, Vertical, Through Hole. [79108](#) Milli-Grid™ Flex-to-Board, Vertical Receptacle. Milli-Grid™ Receptacle, Surface Mount. [79109](#). [87381](#)

Stackable	No
Surface Mount Compatible (SMC)	Yes
Temperature Range - Operating	-55°C to +105°C
Termination Interface: Style	Through Hole

Electrical

Current - Maximum per Contact	2A
Voltage - Maximum	125V

Solder Process Data

Lead-free Process Capability	Wave Capable (TH only)
Process Temperature max. C	250

Material Info**Reference - Drawing Numbers**

Product Specification	PS-87761-100
Sales Drawing	SD-87758-107

This document was generated on 05/25/2010

PLEASE CHECK WWW.MOLEX.COM FOR LATEST PART INFORMATION

10 9 8 7 6 5 4 3 2 1

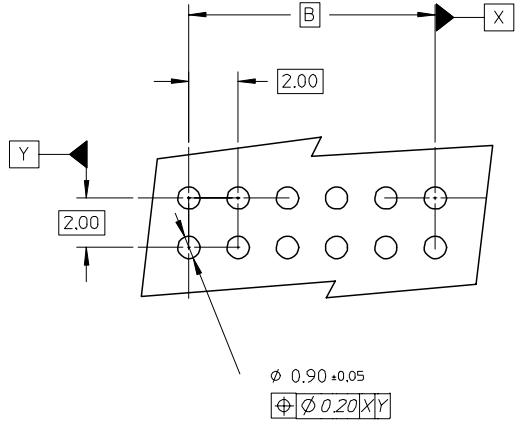
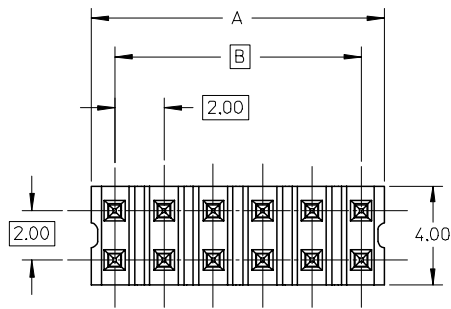

LEGEND
 87758- * * * *
 CKT SIZE (SEE SHT 2 TABLE) PLATING (SEE NOTE 2)

- NOTES:**
- MATERIAL:
 HOUSING: 30% G.F. NYLON 46, 94V-0, COLOR: BLACK
 PIN: 0.50mm SQ. PHOSPHOR BRONZE 510
 - PLATING:
 **16 - 0.38um MIN GOLD IN CONTACT AREA.
 TIN IN SOLDER AREA, BOTH OVER NICKEL OVERALL.
 **17 - 0.76um MIN GOLD IN CONTACT AREA.
 TIN IN SOLDER AREA, BOTH OVER NICKEL OVERALL.
 **18 - 2.54um MIN TIN OVER NICKEL OVERALL.
 - 12 CKT USED FOR ILLUSTRATION ONLY
 - PACKED IN POCKET TRAY
 - PIN PUSHOUT FORCE: 1KG MIN IN EITHER DIRECTION
 - △ CKT 4 AND 6 IS CUT FROM CKT 8 AND 12 RESPECTIVELY.
 CKT 2 ARE CUT FROM ANY LARGER CKT SIZE. ROUGH EDGES ARE EXPECTED ALONG THE CUTTING EDGES.
 - PRODUCT SPEC PS-87761-100 APPLIES.
 - RECOMMENDED PCB THICKNESS IS 1.60±0.10

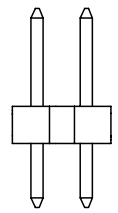
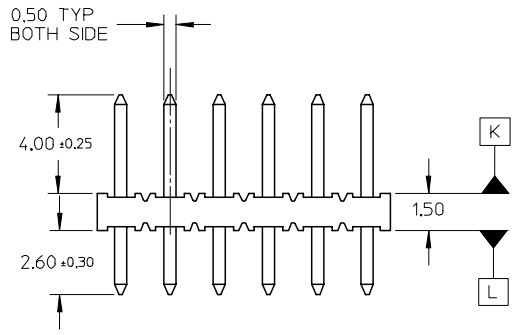

$\phi 0.71 \pm 0.07$
 $\phi \phi 0.30 \text{ (M)}$



VIEW P

$\phi 0.71 \pm 0.07$
 $\phi \phi 0.30 \text{ (M)}$

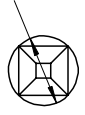

VIEW Q

EC NO: S2005-0715 2005/05/16 DRAWN:KCHO CHKD:PTLIM APPR:SCLOW 2005/05/18 2005/05/19	QUALITY SYMBOLS ▽=0 ∇=0	GENERAL TOLERANCES (UNLESS SPECIFIED)		DIMENSION STYLE MM ONLY	SCALE NTS	DESIGN UNITS METRIC	THIRD ANGLE PROJECTION		
REV A2	DESCRIPTION	4 PLACES	± ---	± ---	DRAWN BY KSEE	DATE 2003/10/30	TITLE SALES DRAWING 2MM DUAL ROW SINGLE WAFER, VERTICAL T/H HDR		
		3 PLACES	± ---	± ---	CHECKED BY KCL ING	DATE 2004/01/05			
		2 PLACES	± 0.20	± ---	APPROVED BY SKTOH	DATE 2004/01/05	MOLEX INCORPORATED		
		1 PLACE	± ---	± ---	MATERIAL NO. SEE TABLE	DOCUMENT NO. SD-87758-107			
		ANGULAR ± 3 °		DRAFT WHERE APPLICABLE MUST REMAIN WITHIN DIMENSIONS		THIS DRAWING CONTAINS INFORMATION THAT IS PROPRIETARY TO MOLEX INCORPORATED AND SHOULD NOT BE USED WITHOUT WRITTEN PERMISSION			

9 8 7 6 5 4 3 2 1

	10	9	8	7	6	5	4	3	2	1
F	PART NUMBER	CKT SIZE	A	B						
	87758-02**	2	NA	NA						
	87758-04**	4	NA	2.00						
	87758-06**	6	NA	4.00						
	87758-08**	8	7.90	6.00						
	87758-10**	10	9.90	8.00						
E	87758-12**	12	11.90	10.00						
	87758-14**	14	13.90	12.00						
	87758-16**	16	15.90	14.00						
	87758-18**	18	17.90	16.00						
	87758-20**	20	19.90	18.00						
	87758-22**	22	21.90	20.00						
D	87758-24**	24	23.90	22.00						
	87758-26**	26	25.90	24.00						
	87758-28**	28	27.90	26.00						
	87758-30**	30	29.90	28.00						
	87758-32**	32	31.90	30.00						
	87758-34**	34	33.90	32.00						
C	87758-36**	36	35.90	34.00						
	87758-38**	38	37.90	36.00						
	87758-40**	40	39.90	38.00						
	87758-42**	42	41.90	40.00						
	87758-44**	44	43.90	42.00						
	87758-46**	46	45.90	44.00						
	87758-48**	48	47.90	46.00						
B	87758-50**	50	49.90	48.00						

CKT SIZE	PART NO. WITH CAP IN TUBE	PART NO. WITH CAP IN TAPE/REEL	PLATING TYPE
8	87758-0814	87758-0815	**16
22	87758-5126	87758-5111	MOLEX INC.

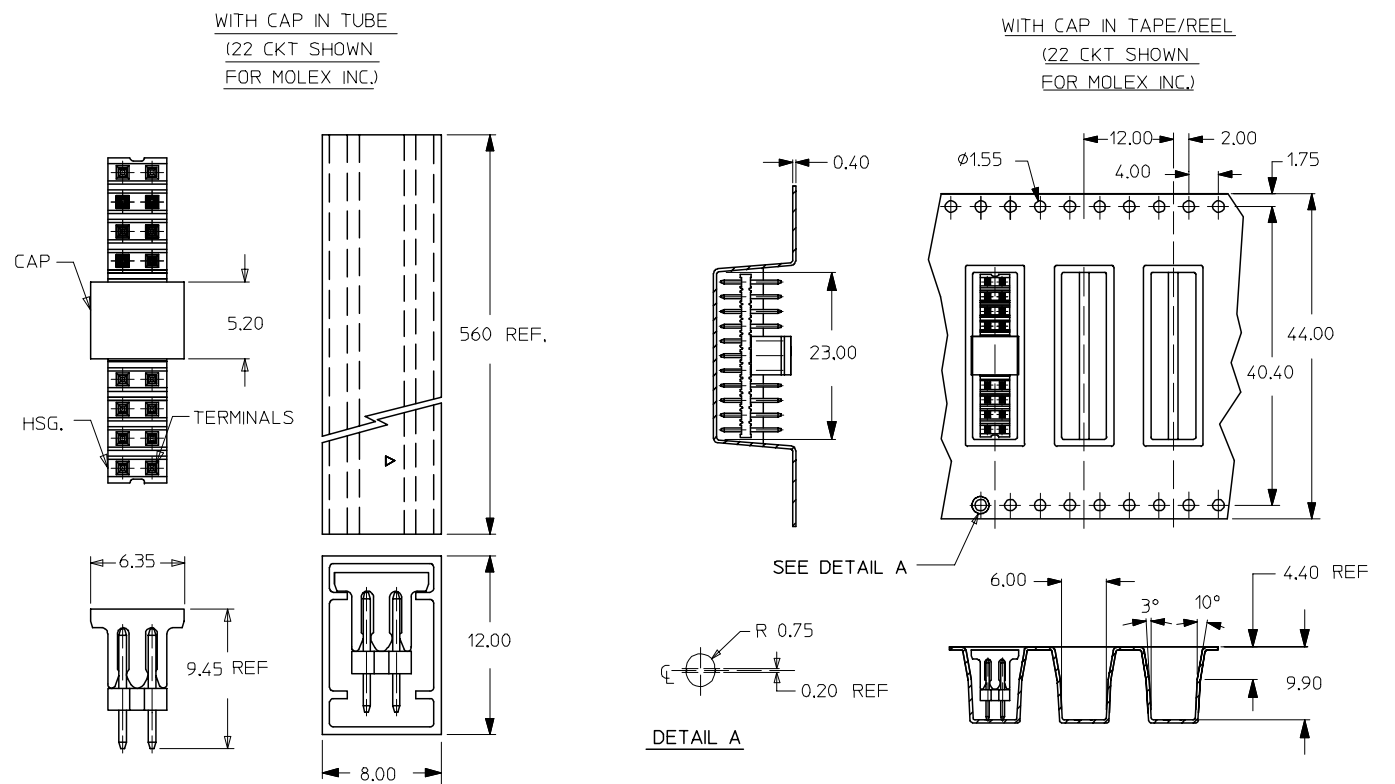

REV	DESCRIPTION	DATE	BY
A2	APPR: SLOW	2005/05/19	
	CHKD: PTLIM	2005/05/18	
	DRWN: KCHO	2005/05/16	
	EC NO: S2005-0715		

QUALITY SYMBOLS	GENERAL TOLERANCES (UNLESS SPECIFIED)	DIMENSION STYLE	SCALE	DESIGN UNITS	THIRD ANGLE PROJECTION	
▽=0 ▽=0	4 PLACES ± --- ± --- 3 PLACES ± --- ± --- 2 PLACES ± 0.20 ± --- 1 PLACE ± --- ± --- ANGULAR ± 3°	MM ONLY	NTS	METRIC		
		DRAWN BY: KSEE DATE: 2003/10/30			SALES DRAWING 2MM DUAL ROW SINGLE WAFER, VERTICAL T/H HDR MOLEX INCORPORATED	
		CHECKED BY: KCLING DATE: 2004/01/05				
		APPROVED BY: SKTOH DATE: 2004/01/05				
		MATERIAL NO. SEE TABLE		DOCUMENT NO. SD-87758-107	SHEET NO. 2 OF 2	
		DRAFT WHERE APPLICABLE MUST REMAIN WITHIN DIMENSIONS				
		THIS DRAWING CONTAINS INFORMATION THAT IS PROPRIETARY TO MOLEX INCORPORATED AND SHOULD NOT BE USED WITHOUT WRITTEN PERMISSION				