



15W, Filterless, Spread-Spectrum, Mono/Stereo, Class D Amplifiers

General Description

The MAX9703/MAX9704 mono/stereo class D audio power amplifiers provide class AB amplifier performance with class D efficiency, conserving board space and eliminating the need for a bulky heatsink. Using a class D architecture, these devices deliver up to 15W while offering up to 78% efficiency. Proprietary and patent-protected modulation and switching schemes render the traditional class D output filter unnecessary.

The MAX9703/MAX9704 offer two modulation schemes: a fixed-frequency mode (FFM), and a spread-spectrum mode (SSM) that reduces EMI-radiated emissions due to the modulation frequency. The device utilizes a fully differential architecture, a full bridged output, and comprehensive click-and-pop suppression.

The MAX9703/MAX9704 feature high 80dB PSRR, low 0.07% THD+N, and SNR in excess of 100dB. Short-circuit and thermal-overload protection prevent the devices from being damaged during a fault condition. The MAX9703 is available in a 32-pin TQFN (5mm x 5mm x 0.8mm) package. The MAX9704 is available in a 32-pin TQFN (7mm x 7mm x 0.8mm) package. Both devices are specified over the extended -40°C to +85°C temperature range.

Applications

LCD TVs	Hands-Free Car
LCD Monitors	Phone Adaptors
Desktop PCs	Automotive
LCD Projectors	

Features

- ◆ Filterless Class D Amplifier
- ◆ Unique Spread-Spectrum Mode Offers 5dB Emissions Improvement Over Conventional Methods
- ◆ Up to 78% Efficient
- ◆ 15W Output Power into 8Ω
- ◆ Up to 20W Peak Power
- ◆ Low 0.07% THD+N
- ◆ High PSRR (80dB at 1kHz)
- ◆ 10V to 25V Single-Supply Operation
- ◆ Differential Inputs Minimize Common-Mode Noise
- ◆ Pin-Selectable Gain Reduces Component Count
- ◆ Industry-Leading Click-and-Pop Suppression
- ◆ Low Quiescent Current (24mA)
- ◆ Low-Power Shutdown Mode (0.2μA)
- ◆ Short-Circuit and Thermal-Overload Protection
- ◆ Available in Thermally Efficient, Space-Saving Packages
 - 32-Pin TQFN (5mm x 5mm x 0.8mm)—MAX9703
 - 32-Pin TQFN (7mm x 7mm x 0.8mm)—MAX9704

MAX9703/MAX9704

Ordering Information

PART	TEMP RANGE	PIN-PACKAGE	AMP
MAX9703ETJ	-40°C to +85°C	32 TQFN-EP*	Mono
MAX9704ETJ	-40°C to +85°C	32 TQFN-EP*	Stereo

*EP = Exposed paddle.

Block Diagrams

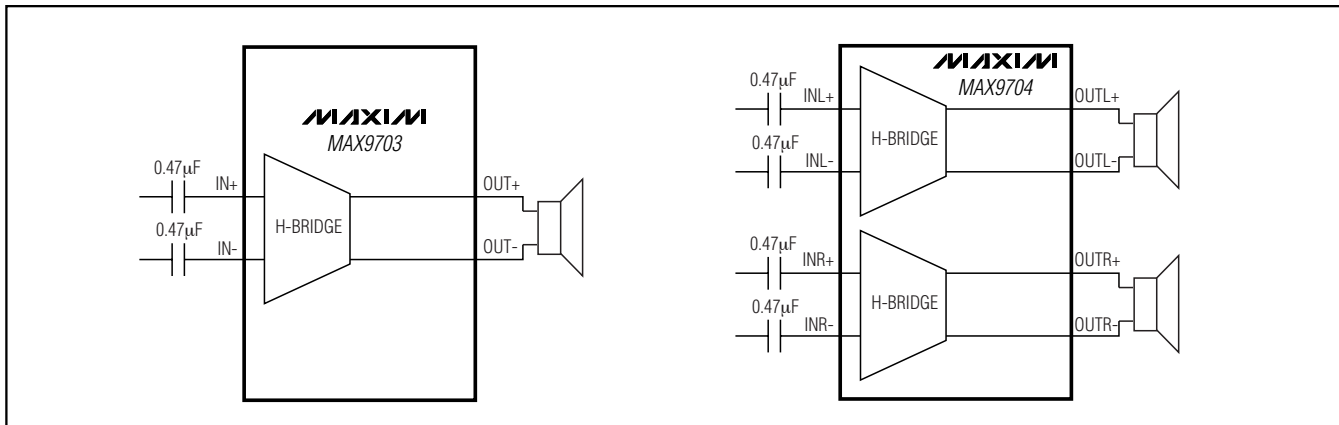

Pin Configurations appear at end of data sheet.



Maxim Integrated Products 1

For pricing, delivery, and ordering information, please contact Maxim/Dallas Direct! at 1-888-629-4642, or visit Maxim's website at www.maxim-ic.com.

15W, Filterless, Spread-Spectrum, Mono/Stereo, Class D Amplifiers

ABSOLUTE MAXIMUM RATINGS

(All voltages referenced to GND.)

V _{DD} to PGND, AGND	30V
OUTR ₋ , OUTL ₋ , C1N	-0.3V to (V _{DD} + 0.3V)
C1P	(V _{DD} - 0.3V) to (CHOLD + 0.3V)
CHOLD	(V _{DD} - 0.3V) to +40V
All Other Pins to GND	-0.3V to +12V
Duration of OUTR ₋ /OUTL ₋ Short Circuit to GND, V _{DD}	10s
Continuous Input Current (V _{DD} , PGND)	1.6A
Continuous Input Current	0.8A

Continuous Input Current (all other pins)	±20mA
Continuous Power Dissipation (T _A = +70°C)	
MAX9703 32-Pin TQFN (derate 21.3mW/°C above +70°C)	1702.1mW
MAX9704 32-Pin TQFN (derate 33.3mW/°C above +70°C)	2666.7mW
Junction Temperature	+150°C
Operating Temperature Range	-40°C to +85°C
Storage Temperature Range	-65°C to +150°C
Lead Temperature (soldering, 10s)	+300°C

Stresses beyond those listed under "Absolute Maximum Ratings" may cause permanent damage to the device. These are stress ratings only, and functional operation of the device at these or any other conditions beyond those indicated in the operational sections of the specifications is not implied. Exposure to absolute maximum rating conditions for extended periods may affect device reliability.

ELECTRICAL CHARACTERISTICS

(V_{DD} = 15V, GND = PGND = 0V, $\overline{\text{SHDN}} \geq V_{IH}$, A_v = 16dB, C_{SS} = C_{IN} = C_{REG} = 0.47μF, C1 = 100nF, C2 = 1μF, FS1 = FS2 = GND (f_S = 660kHz), R_L connected between OUTL₊ and OUTL₋ and OUTR₊ and OUTR₋, T_A = T_{MIN} to T_{MAX}, unless otherwise noted. Typical values are at T_A = +25°C.) (Notes 1, 2)

PARAMETER	SYMBOL	CONDITIONS	MIN	TYP	MAX	UNITS	
GENERAL							
Supply Voltage Range	V _{DD}	Inferred from PSRR test	10		25	V	
Quiescent Current	I _{DD}	R _L = OPEN	MAX9703	14	22	mA	
			MAX9704	24	34		
Shutdown Current	I _{SHDN}			0.2	1.5	μA	
Turn-On Time	t _{ON}	C _{SS} = 470nF		100		ms	
		C _{SS} = 180nF		50			
Amplifier Output Resistance in Shutdown		$\overline{\text{SHDN}} = \text{GND}$	150	330		kΩ	
Input Impedance	R _{IN}	A _v = 13dB	35	58	80	kΩ	
		A _v = 16dB	30	48	65		
		A _v = 19.1dB	23	39	55		
		A _v = 29.6dB	10	15	22		
Voltage Gain	A _v	G1 = L, G2 = L	29.4	29.6	29.8	dB	
		G1 = L, G2 = H	18.9	19.1	19.3		
		G1 = H, G2 = L	12.8	13	13.2		
		G1 = H, G2 = H	15.9	16	16.3		
Gain Matching		Between channels (MAX9704)		0.5		%	
Output Offset Voltage	V _{OS}			±6	±30	mV	
Common-Mode Rejection Ratio	CMRR	f _{IN} = 1kHz, input referred		60		dB	
Power-Supply Rejection Ratio (Note 3)	PSRR	V _{DD} = 10V to 25V	54	80		dB	
		200mV _{P-P} ripple	f _{RIPPLE} = 1kHz		80		
			f _{RIPPLE} = 20kHz		66		
Output Power	P _{OUT}	THD+N = 10%, f = 1kHz, T _A = +25°C	R _L = 4Ω		7.5	W	
			R _L = 8Ω, V _{DD} = 20V		20		

15W, Filterless, Spread-Spectrum, Mono/Stereo, Class D Amplifiers

MAX9703/MAX9704

ELECTRICAL CHARACTERISTICS (continued)

($V_{DD} = 15V$, $GND = PGND = 0V$, $\overline{SHDN} \geq V_{IH}$, $A_v = 16dB$, $C_{SS} = C_{IN} = C_{REG} = 0.47\mu F$, $C_1 = 100nF$, $C_2 = 1\mu F$, $FS1 = FS2 = GND$ ($f_S = 660kHz$), R_L connected between $OUTL+$ and $OUTL-$ and $OUTR+$ and $OUTR-$, $T_A = T_{MIN}$ to T_{MAX} , unless otherwise noted. Typical values are at $T_A = +25^\circ C$.) (Notes 1, 2)

PARAMETER	SYMBOL	CONDITIONS	MIN	TYP	MAX	UNITS
Total Harmonic Distortion Plus Noise	THD+N	$f_{IN} = 1kHz$, either FFM or SSM, $R_L = 8\Omega$, $P_{OUT} = 4W$		0.07		%
Signal-to-Noise Ratio	SNR	$R_L = 8\Omega$, $P_{OUT} = 10W$, $f = 1kHz$	BW = 22Hz to 22kHz	FFM	94	dB
				SSM	88	
			A-weighted	FFM	97	
				SSM	91	
Crosstalk		Left to right, right to left, 8Ω load, $f_{IN} = 10kHz$		65		dB
Oscillator Frequency	f_{OSC}	FS1 = L, FS2 = L	560	670	800	kHz
		FS1 = L, FS2 = H		940		
		FS1 = H, FS2 = L		470		
		FS1 = H, FS2 = H (spread-spectrum mode)		670 $\pm 7\%$		
Efficiency	η	$P_{OUT} = 15W$, $f = 1kHz$, $R_L = 8\Omega$		78		%
Regulator Output	V_{REG}			6		V
DIGITAL INPUTS (\overline{SHDN}, FS_{-}, G_{-}) (Note 4)						
Input Thresholds		V_{IH}	2.5			V
		V_{IL}	0.8			
Input Leakage Current				± 1		μA

Note 1: All devices are 100% production tested at $+25^\circ C$. All temperature limits are guaranteed by design.

Note 2: Testing performed with a resistive load in series with an inductor to simulate an actual speaker load. For $R_L = 8\Omega$, $L = 68\mu H$. For $R_L = 4\Omega$, $L = 33\mu H$.

Note 3: PSRR is specified with the amplifier inputs connected to GND through C_{IN} .

Note 4: Do not apply more than 8V to any logic pin.

15W, Filterless, Spread-Spectrum, Mono/Stereo, Class D Amplifiers

Typical Operating Characteristics

(33 μ H with 4 Ω , 68 μ H with 8 Ω , part in SSM mode, 136 μ H with 16 Ω , measurement BW = 22Hz to 22kHz, unless otherwise noted.)

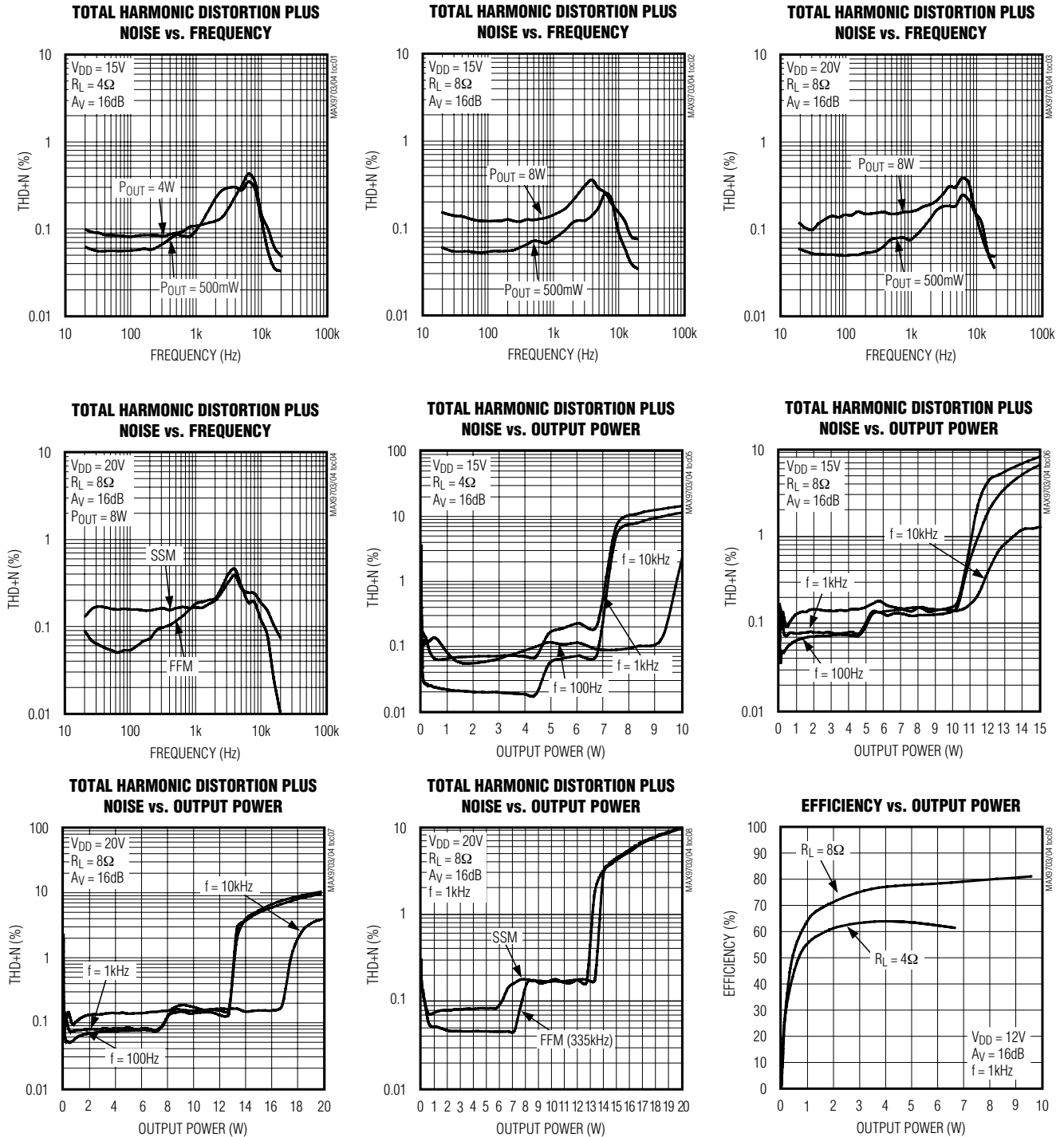

15W, Filterless, Spread-Spectrum, Mono/Stereo, Class D Amplifiers

Typical Operating Characteristics (continued)

(33 μ H with 4 Ω , 68 μ H with 8 Ω , part in SSM mode, 136 μ H with 16 Ω , measurement BW = 22Hz to 22kHz, unless otherwise noted.)

MAX9703/MAX9704

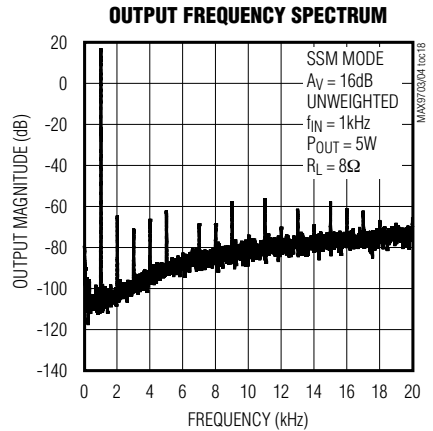
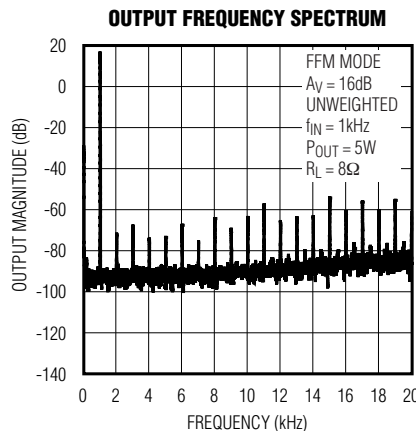
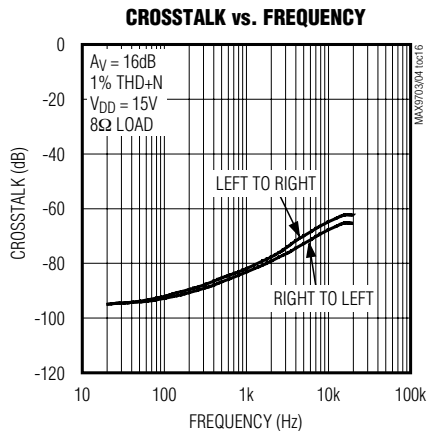
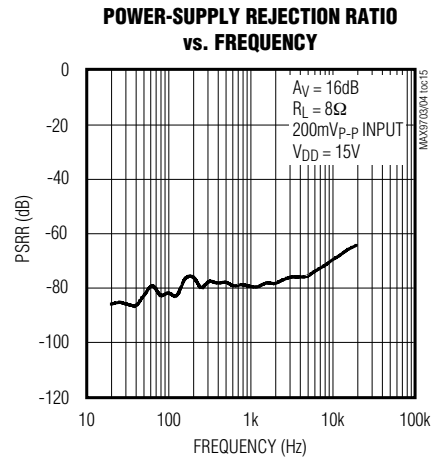
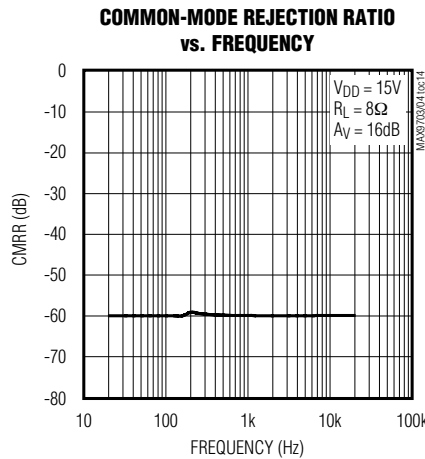
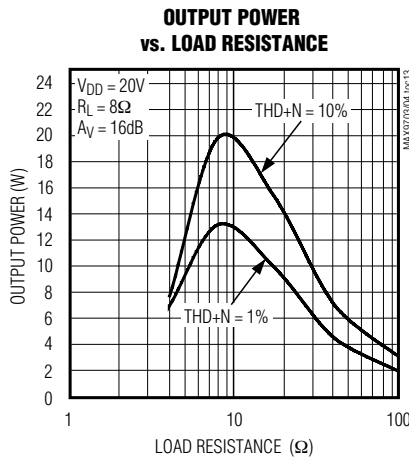
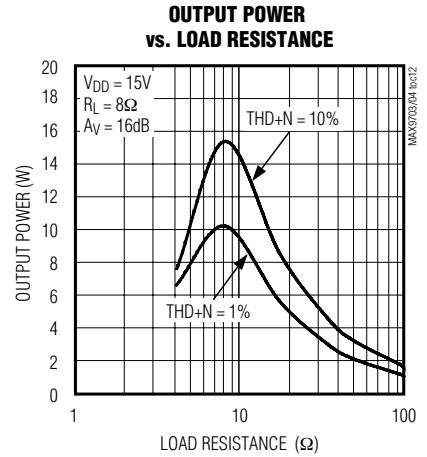
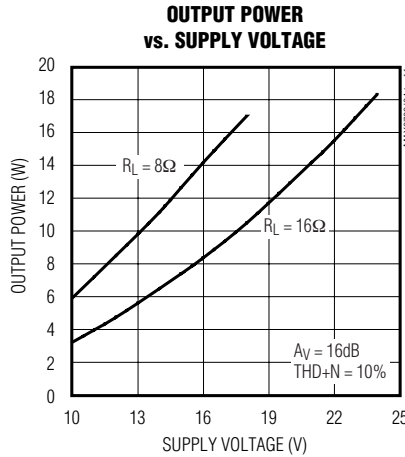
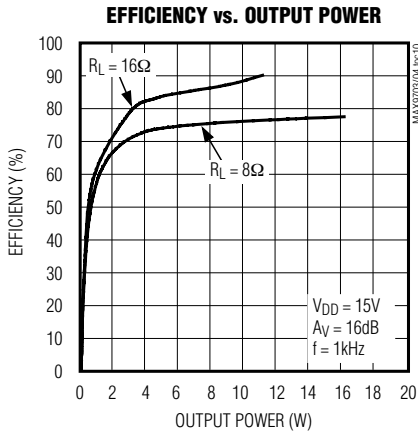

15W, Filterless, Spread-Spectrum, Mono/Stereo, Class D Amplifiers

Typical Operating Characteristics (continued)

(33 μ H with 4 Ω , 68 μ H with 8 Ω , part in SSM mode, 136 μ H with 16 Ω , measurement BW = 22Hz to 22kHz, unless otherwise noted.)

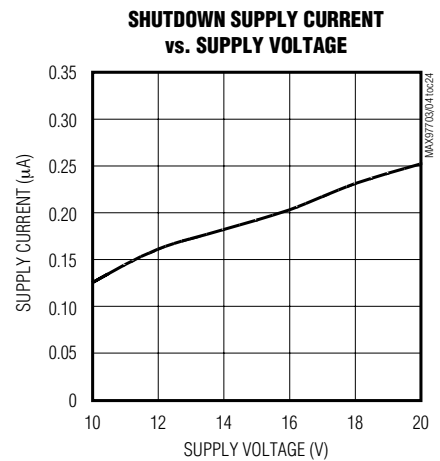
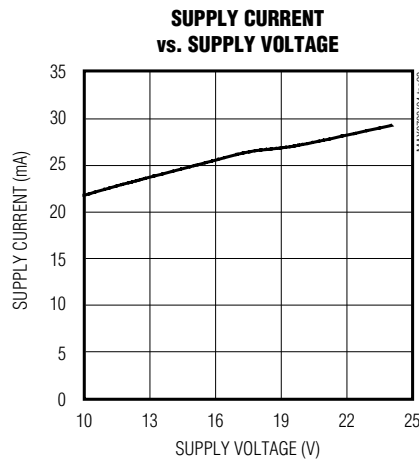
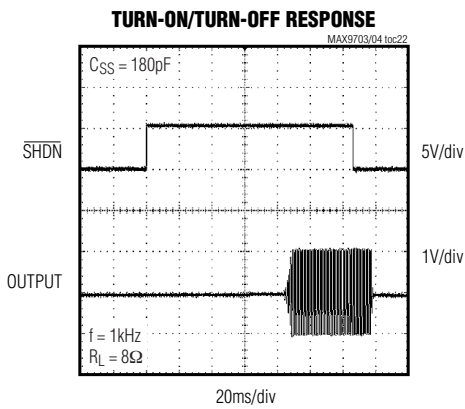
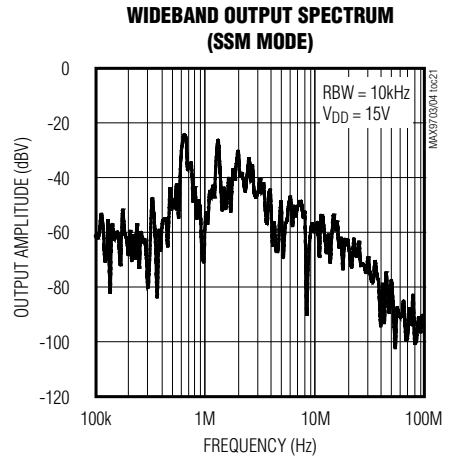
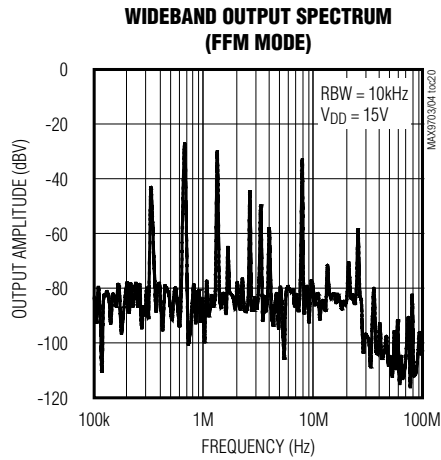
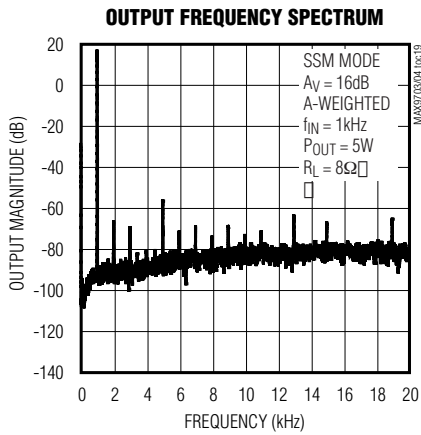

15W, Filterless, Spread-Spectrum, Mono/Stereo, Class D Amplifiers

Pin Description

MAX9703/MAX9704

PIN		NAME	FUNCTION
MAX9703	MAX9704		
1, 2, 23, 24	1, 2, 23, 24	PGND	Power Ground
3, 4, 21, 22	3, 4, 21, 22	V _{DD}	Power-Supply Input
5	5	C1N	Charge-Pump Flying Capacitor Negative Terminal
6	6	C1P	Charge-Pump Flying Capacitor Positive Terminal
7	7	CHOLD	Charge-Pump Hold Capacitor. Connect a 1μF capacitor from CHOLD to V _{DD} .
8, 17, 20, 25, 26, 31, 32	8	N.C.	No Connection. Not internally connected.
9	14	REG	Internal Regulator Output. Bypass with a 0.47μF capacitor to PGND.
10	13	AGND	Analog Ground
11	—	IN-	Negative Input
12	—	IN+	Positive Input
13	12	SS	Soft-Start. Connect a 0.47μF capacitor from SS to GND to enable soft-start feature.
14	11	$\overline{\text{SHDN}}$	Active-Low Shutdown. Connect $\overline{\text{SHDN}}$ to GND to disable the device. Connect to V _{DD} for normal operation.
15	17	G1	Gain-Select Input 1
16	18	G2	Gain-Select Input 2
18	19	FS1	Frequency-Select Input 1
19	20	FS2	Frequency-Select Input 2
27, 28	—	OUT-	Negative Audio Output
29, 30	—	OUT+	Positive Audio Output
—	9	INL-	Left-Channel Negative Input
—	10	INL+	Left-Channel Positive Input
—	15	INR-	Right-Channel Negative Input
—	16	INR+	Right-Channel Positive Input
—	25, 26	OUTR-	Right-Channel Negative Audio Output
—	27, 28	OUTR+	Right-Channel Positive Audio Output
—	29, 30	OUTL-	Left-Channel Negative Audio Output
—	31, 32	OUTL+	Left-Channel Positive Audio Output
—	—	EP	Exposed Paddle. Connect to GND.

15W, Filterless, Spread-Spectrum, Mono/Stereo, Class D Amplifiers

Detailed Description

The MAX9703/MAX9704 filterless, class D audio power amplifiers feature several improvements to switch-mode amplifier technology. The MAX9703 is a mono amplifier, the MAX9704 is a stereo amplifier. These devices offer class AB performance with class D efficiency, while occupying minimal board space. A unique filterless modulation scheme and spread-spectrum switching mode create a compact, flexible, low-noise, efficient audio power amplifier. The differential input architecture reduces common-mode noise pickup, and can be used without input-coupling capacitors. The devices can also be configured as a single-ended input amplifier.

Comparators monitor the device inputs and compare the complementary input voltages to the triangle waveform. The comparators trip when the input magnitude of the triangle exceeds their corresponding input voltage.

Operating Modes

Fixed-Frequency Modulation (FFM) Mode

The MAX9703/MAX9704 feature three FFM modes with different switching frequencies (Table 1). In FFM mode, the frequency spectrum of the class D output consists of the fundamental switching frequency and its associated harmonics (see the Wideband FFT graph in the *Typical Operating Characteristics*). The MAX9703/MAX9704 allow the switching frequency to be changed by $\pm 35\%$, should the frequency of one or more of the harmonics fall in a sensitive band. This can be done at any time and does not affect audio reproduction.

Spread-Spectrum Modulation (SSM) Mode

The MAX9703/MAX9704 feature a unique, patented spread-spectrum mode that flattens the wideband spectral components, improving EMI emissions that may be radiated by the speaker and cables. This mode is enabled by setting FS1 = FS2 = H. In SSM mode, the switching frequency varies randomly by $\pm 7\%$ around the center frequency (670kHz). The modulation scheme remains the same, but the period of the triangle waveform changes from cycle to cycle. Instead of a large amount of spectral energy present at multiples of the switching frequency, the energy is now spread over a bandwidth that increases with frequency. Above a few megahertz, the wideband spectrum looks like white noise for EMI purposes.

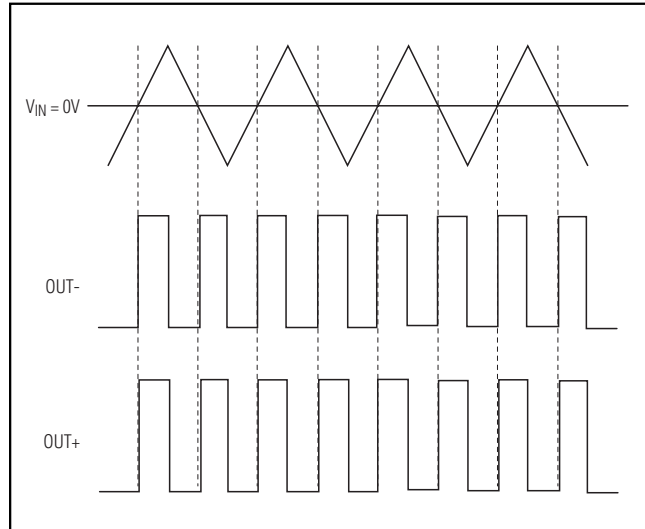

Figure 1. MAX9704 Outputs with No Input Signal Applied

Table 1. Operating Modes

FS1	FS2	SWITCHING MODE (kHz)
L	L	670
L	H	940
H	L	470
H	H	670 $\pm 7\%$

Efficiency

Efficiency of a class D amplifier is attributed to the region of operation of the output stage transistors. In a class D amplifier, the output transistors act as current-steering switches and consume negligible additional power. Any power loss associated with the class D output stage is mostly due to the I^2R loss of the MOSFET on-resistance, and quiescent current overhead.

The theoretical best efficiency of a linear amplifier is 78%; however, that efficiency is only exhibited at peak output powers. Under normal operating levels (typical music reproduction levels), efficiency falls below 30%, whereas the MAX9704 still exhibits $>78\%$ efficiency under the same conditions (Figure 2).

15W, Filterless, Spread-Spectrum, Mono/Stereo, Class D Amplifiers

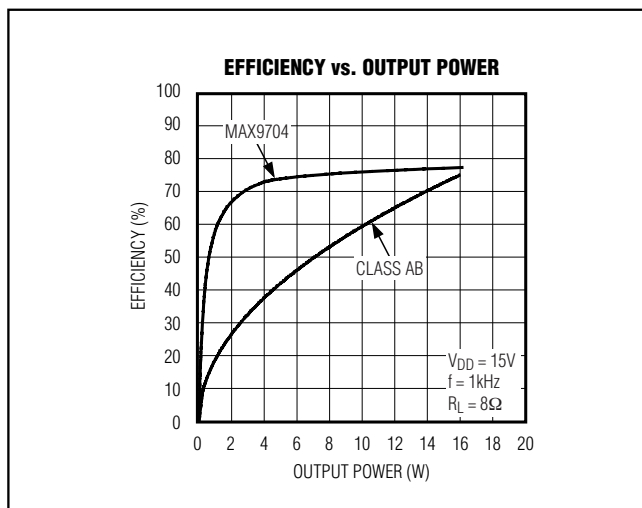

Figure 2. MAX9704 Efficiency vs. Class AB Efficiency

Shutdown

The MAX9703/MAX9704 have a shutdown mode that reduces power consumption and extends battery life. Driving SHDN low places the device in low-power (0.2μA) shutdown mode. Connect SHDN to a logic high for normal operation.

Click-and-Pop Suppression

The MAX9703/MAX9704 feature comprehensive click-and-pop suppression that eliminates audible transients on startup and shutdown. While in shutdown, the H-bridge is pulled to GND through 330kΩ. During startup, or power-up, the input amplifiers are muted and an internal loop sets the modulator bias voltages to the correct levels, preventing clicks and pops when the H-bridge is subsequently enabled. Following startup, a soft-start function gradually unmutes the input amplifiers. The value of the soft-start capacitor has an impact on the click/pop levels. For optimum performance, C_{SS} should be at least 180nF with a voltage rating of at least 7V.

Mute Function

The MAX9703/MAX9704 features a clickless/popless mute mode. When the device is muted, the outputs stop switching, muting the speaker. Mute only affects the output stage and does not shut down the device. To mute the MAX9703/MAX9704, drive SS to GND by using a MOSFET pulldown (Figure 3). Driving SS to GND during the power-up/down or shutdown/turn-on cycle optimizes click-and-pop suppression.

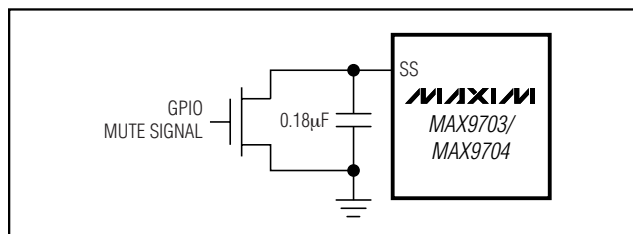

Figure 3. MAX9703/MAX9704 Mute Circuit

Applications Information

Filterless Operation

Traditional class D amplifiers require an output filter to recover the audio signal from the amplifier's PWM output. The filters add cost, increase the solution size of the amplifier, and can decrease efficiency. The traditional PWM scheme uses large differential output swings ($2 \times V_{DD}$ peak-to-peak) and causes large ripple currents. Any parasitic resistance in the filter components results in a loss of power, lowering the efficiency.

The MAX9703/MAX9704 do not require an output filter. The devices rely on the inherent inductance of the speaker coil and the natural filtering of both the speaker and the human ear to recover the audio component of the square-wave output. Eliminating the output filter results in a smaller, less-costly, more-efficient solution.

Because the frequency of the MAX9703/MAX9704 output is well beyond the bandwidth of most speakers, voice coil movement due to the square-wave frequency is very small. Although this movement is small, a speaker not designed to handle the additional power can be damaged. For optimum results, use a speaker with a series inductance $> 30\mu\text{H}$. Typical 8Ω speakers exhibit series inductances in the range of 30μH to 100μH. Optimum efficiency is achieved with speaker inductances $> 60\mu\text{H}$.

Gain Selection

Table 2 shows the suggested gain settings to attain a maximum output power from a given peak input voltage and given load.

Output Offset

Unlike a class AB amplifier, the output offset voltage of class D amplifiers does not noticeably increase quiescent current draw when a load is applied. This is due to the power conversion of the class D amplifier. For example, an 8mVDC offset across an 8Ω load results in 1mA extra current consumption in a class AB device. In the class D case, an 8mV offset into 8Ω equates

15W, Filterless, Spread-Spectrum, Mono/Stereo, Class D Amplifiers

Table 2. Gain Settings

GAIN (dB)	INPUT DIFF (V _{RMS})	R _L (Ω)	P _{OUT} AT 10% THD+N (W)
13.0	0.67	4	9
16.0	0.48	4	9
19.1	0.33	4	9
29.6	0.10	4	9
13.0	1.23	8	15
16.0	0.86	8	15
19.1	0.61	8	15
29.6	0.19	8	15

to an additional power drain of 8μW. Due to the high efficiency of the class D amplifier, this represents an additional quiescent current draw of: 8μW/(V_{DD}/100 × η), which is in the order of a few microamps.

Input Amplifier

Differential Input

The MAX9703/MAX9704 feature a differential input structure, making them compatible with many CODECs, and offering improved noise immunity over a single-ended input amplifier. In devices such as PCs, noisy digital signals can be picked up by the amplifier's input traces. The signals appear at the amplifiers' inputs as common-mode noise. A differential input amplifier amplifies the difference of the two inputs, any signal common to both inputs is canceled.

Single-Ended Input

The MAX9703/MAX9704 can be configured as single-ended input amplifiers by capacitively coupling either input to GND and driving the other input (Figure 4).

Component Selection

Input Filter

An input capacitor, C_{IN}, in conjunction with the input impedance of the MAX9703/MAX9704, forms a high-pass filter that removes the DC bias from an incoming signal. The AC-coupling capacitor allows the amplifier to bias the signal to an optimum DC level. Assuming zero-source impedance, the -3dB point of the highpass filter is given by:

$$f_{-3dB} = \frac{1}{2\pi R_{IN} C_{IN}}$$

Choose C_{IN} so f_{-3dB} is well below the lowest frequency of interest. Setting f_{-3dB} too high affects the low-frequency response of the amplifier. Use capacitors with dielectrics that have low-voltage coefficients, such as

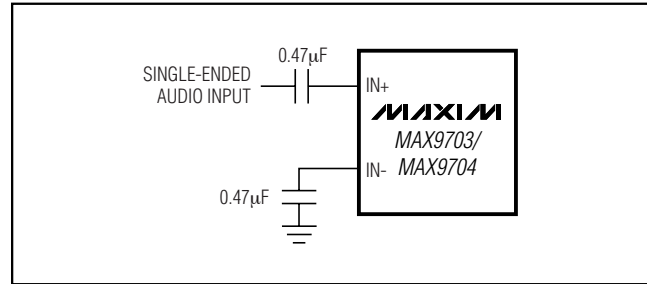

Figure 4. Single-Ended Input

tantalum or aluminum electrolytic. Capacitors with high-voltage coefficients, such as ceramics, may result in increased distortion at low frequencies.

Charge-Pump Capacitor Selection

Use capacitors with an ESR less than 100mΩ for optimum performance. Low-ESR ceramic capacitors minimize the output resistance of the charge pump. For best performance over the extended temperature range, select capacitors with an X7R dielectric.

Flying Capacitor (C1)

The value of the flying capacitor (C1) affects the load regulation and output resistance of the charge pump. A C1 value that is too small degrades the device's ability to provide sufficient current drive. Increasing the value of C1 improves load regulation and reduces the charge-pump output resistance to an extent. Above 1μF, the on-resistance of the switches and the ESR of C1 and C2 dominate.

Hold Capacitor (C2)

The output capacitor value and ESR directly affect the ripple at CHOLD. Increasing C2 reduces output ripple. Likewise, decreasing the ESR of C2 reduces both ripple and output resistance. Lower capacitance values can be used in systems with low maximum output power levels.

Output Filter

The MAX9703/MAX9704 do not require an output filter and can pass FCC emissions standards with unshielded speaker cables. However, output filtering can be used if a design is failing radiated emissions due to board layout or cable length, or the circuit is near EMI-sensitive devices. Use a ferrite bead filter when radiated frequencies above 10MHz are of concern. Use an LC filter when radiated frequencies below 10MHz are of concern, or when long leads connect the amplifier to the speaker. Refer to the MAX9704 Evaluation Kit schematic for details of this filter.

15W, Filterless, Spread-Spectrum, Mono/Stereo, Class D Amplifiers

Sharing Input Sources

In certain systems, a single audio source can be shared by multiple devices (speaker and headphone amplifiers). When sharing inputs, it is common to mute the unused device, rather than completely shutting it down, preventing the unused device inputs from distorting the input signal. Mute the MAX9703/MAX9704 by driving SS low through an open-drain output or MOSFET (see the *System Diagram*). Driving SS low turns off the class D output stage, but does not affect the input bias levels of the MAX9703/MAX9704. Be aware that during normal operation, the voltage at SS can be up to 7V, depending on the MAX9703/MAX9704 supply.

Supply Bypassing/Layout

Proper power-supply bypassing ensures low distortion operation. For optimum performance, bypass V_{DD} to PGND with a 0.1 μ F capacitor as close to each V_{DD} pin as possible. A low-impedance, high-current power-supply connection to V_{DD} is assumed. Additional bulk capacitance should be added as required depending on the application and power-supply characteristics. AGND and PGND should be star connected to system ground. Refer to the MAX9704 Evaluation Kit for layout guidance.

MAX9703/MAX9704

15W, Filterless, Spread-Spectrum, Mono/Stereo, Class D Amplifiers

Functional Diagrams

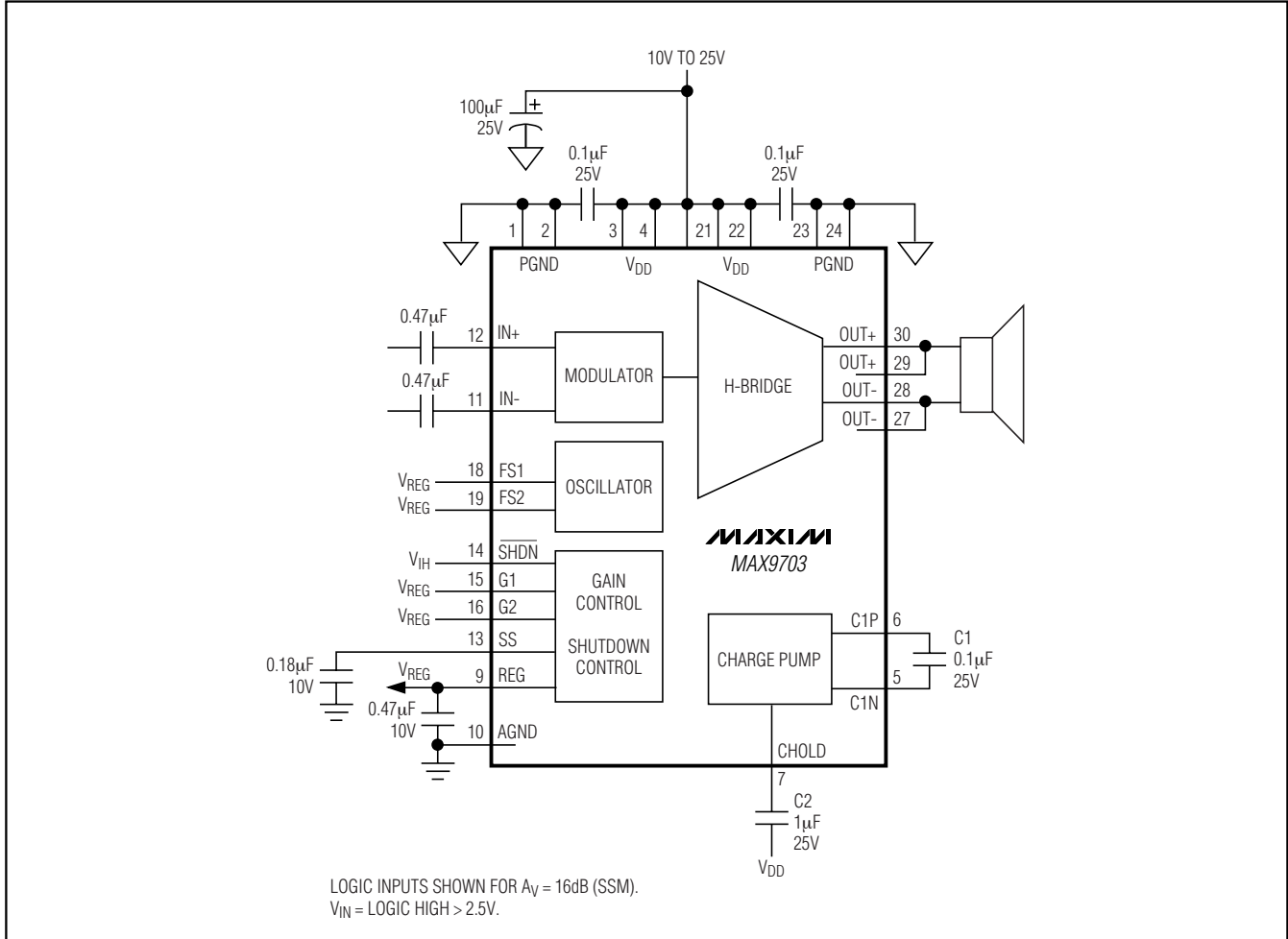

15W, Filterless, Spread-Spectrum, Mono/Stereo, Class D Amplifiers

Functional Diagrams (continued)

MAX9703/MAX9704

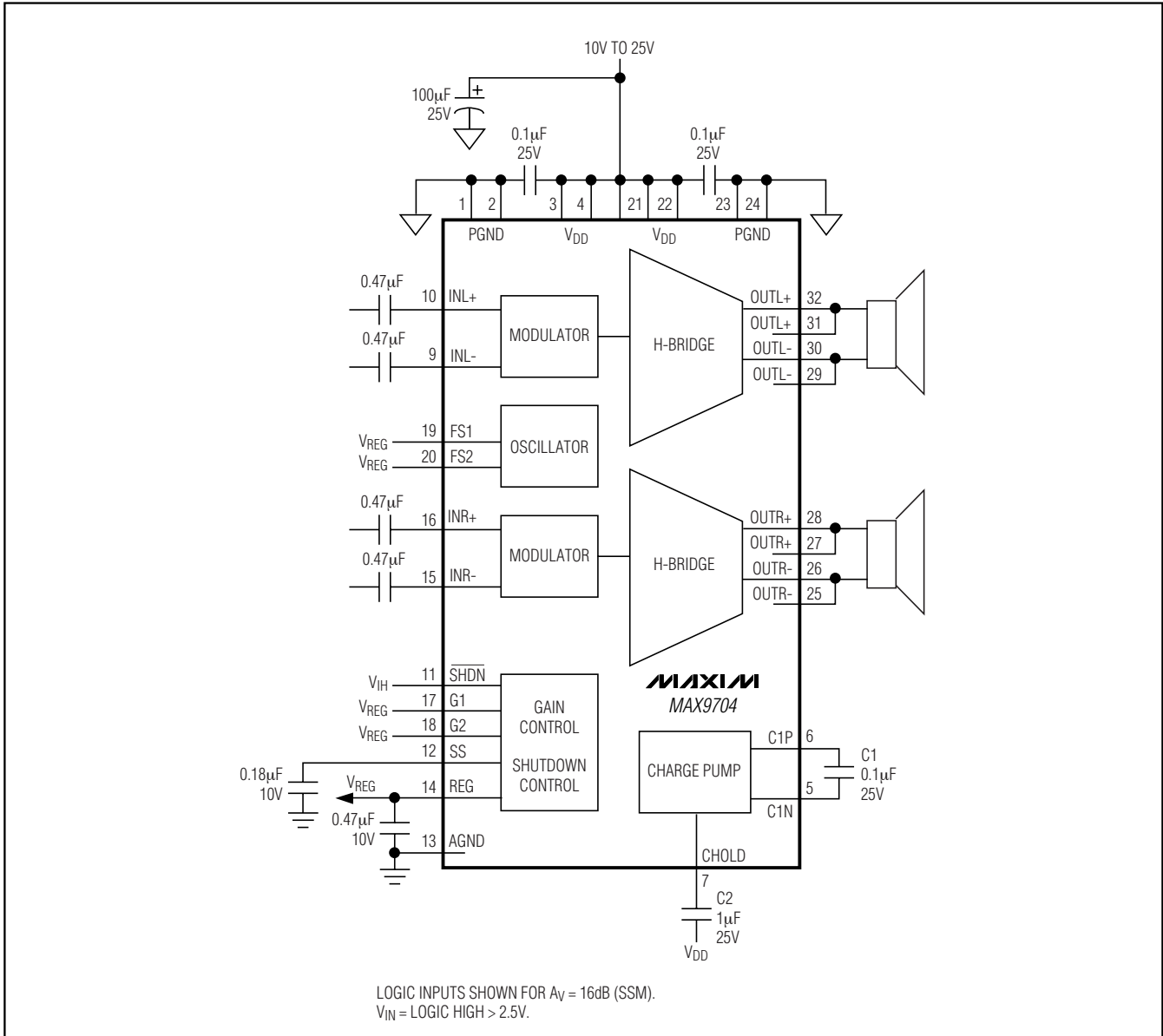

15W, Filterless, Spread-Spectrum, Mono/Stereo, Class D Amplifiers

System Diagram

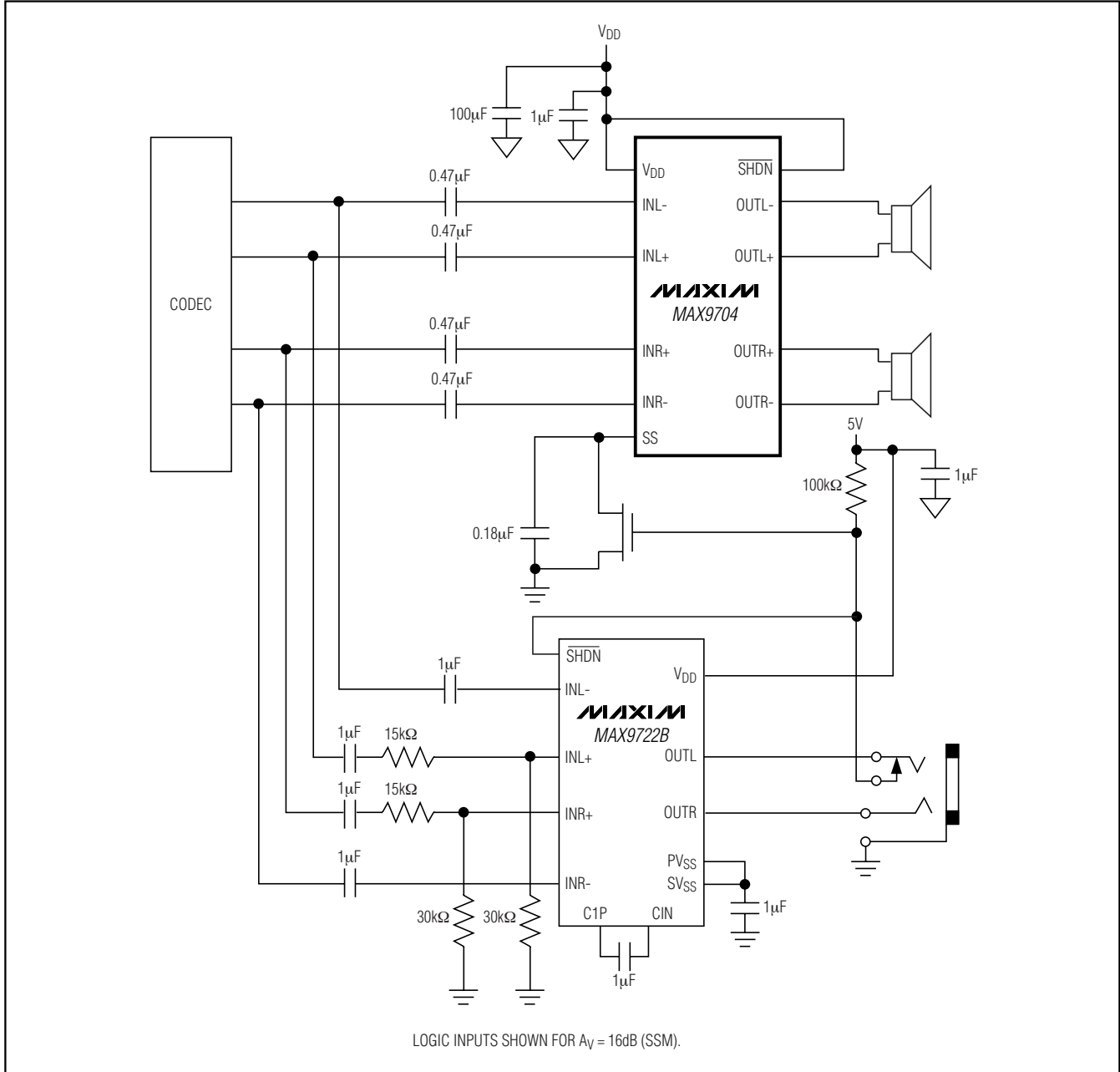

15W, Filterless, Spread-Spectrum, Mono/Stereo, Class D Amplifiers

Pin Configurations

MAX9703/MAX9704

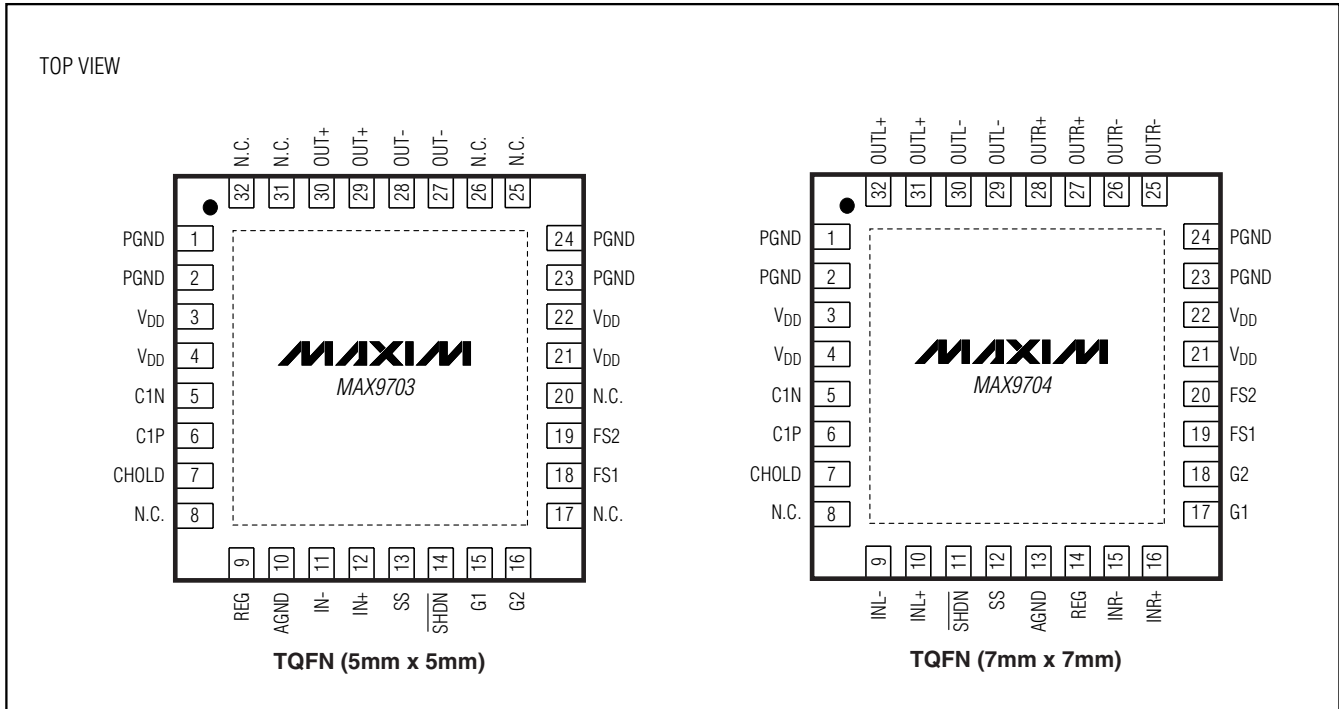

Chip Information

MAX9703 TRANSISTOR COUNT: 3093
 MAX9704 TRANSISTOR COUNT: 4630
 PROCESS: BiCMOS

15W, Filterless, Spread-Spectrum, Mono/Stereo, Class D Amplifiers

Package Information

(The package drawing(s) in this data sheet may not reflect the most current specifications. For the latest package outline information, go to www.maxim-ic.com/packages.)

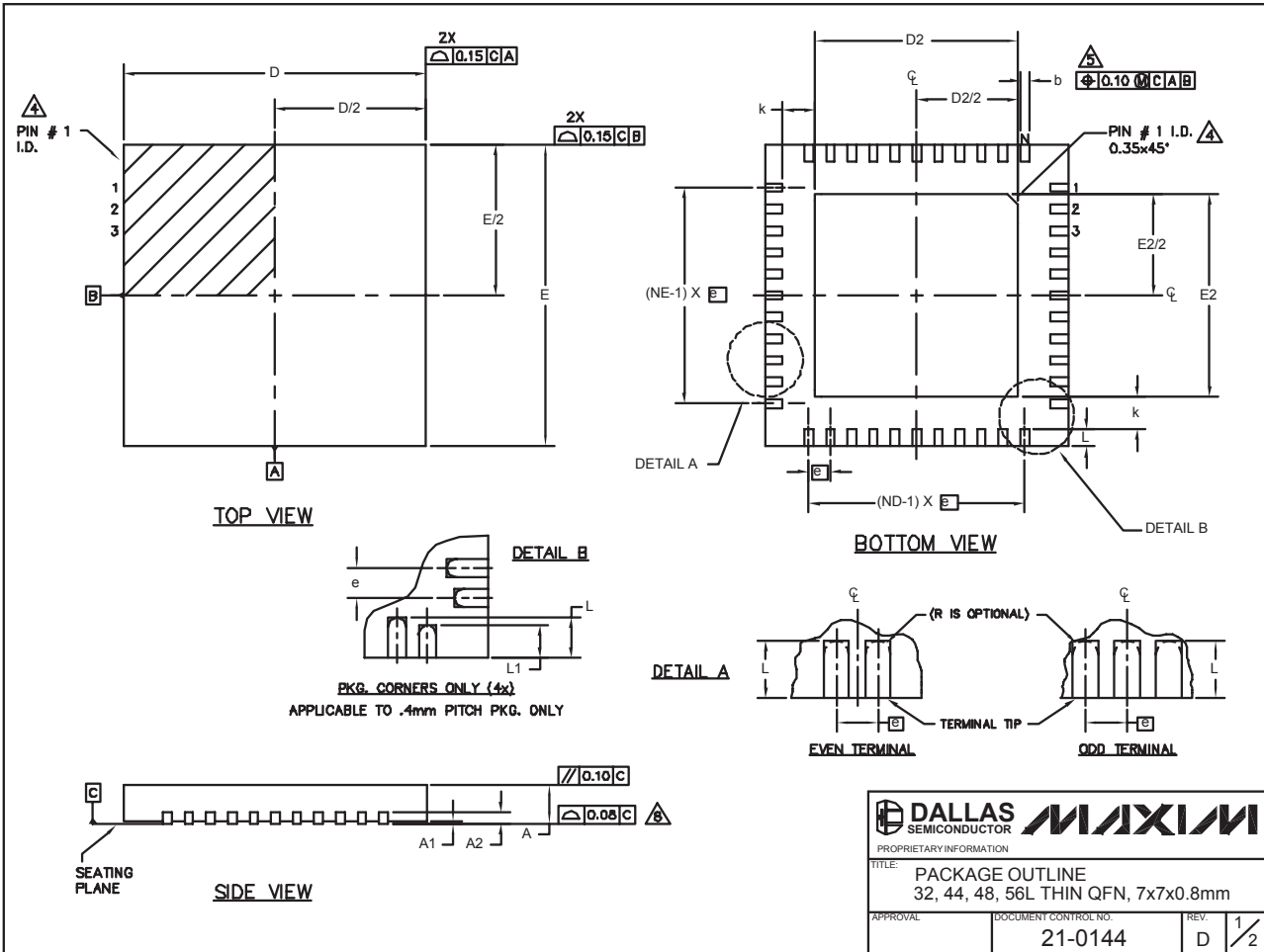

15W, Filterless, Spread-Spectrum, Mono/Stereo, Class D Amplifiers

Package Information (continued)

(The package drawing(s) in this data sheet may not reflect the most current specifications. For the latest package outline information, go to www.maxim-ic.com/packages.)

MAX9703/MAX9704

COMMON DIMENSIONS															EXPOSED PAD VARIATIONS												
PKG	32L 7x7			44L 7x7			48L 7x7			CUSTOM PKG. (T4877-1) 48L 7x7			56L 7x7			PKG. CODES	DEPOPULATED LEADS	D2			E2			JEDEC MO220 REV. C	DOWN BONDS ALLOWED		
	MIN.	NOM.	MAX.	MIN.	NOM.	MAX.	MIN.	NOM.	MAX.	MIN.	NOM.	MAX.	MIN.	NOM.	MAX.			MIN.	NOM.	MAX.	MIN.	NOM.	MAX.				
SYMBOL	MIN.	NOM.	MAX.	MIN.	NOM.	MAX.	MIN.	NOM.	MAX.	MIN.	NOM.	MAX.	MIN.	NOM.	MAX.												
A	0.70	0.75	0.80	0.70	0.75	0.80	0.70	0.75	0.80	0.70	0.75	0.80	0.70	0.75	0.80												
A1	0	0.02	0.05	0	0.02	0.05	0	0.02	0.05	0	0.02	0.05	0	0.02	0.05												
A2	0.20 REF.			0.20 REF.			0.20 REF.			0.20 REF.			0.20 REF.														
b	0.25	0.30	0.35	0.20	0.25	0.30	0.20	0.25	0.30	0.20	0.25	0.30	0.20	0.25	0.30	0.15	0.20	0.25									
D	6.90	7.00	7.10	6.90	7.00	7.10	6.90	7.00	7.10	6.90	7.00	7.10	6.90	7.00	7.10	6.90	7.00	7.10									
E	6.90	7.00	7.10	6.90	7.00	7.10	6.90	7.00	7.10	6.90	7.00	7.10	6.90	7.00	7.10	6.90	7.00	7.10									
e	0.65 BSC.			0.50 BSC.			0.50 BSC.			0.50 BSC.			0.40 BSC.														
k	0.25	-	-	0.25	-	-	0.25	-	-	0.25	-	-	0.25	-	-	0.25	0.35	0.45									
L	0.45	0.55	0.65	0.45	0.55	0.65	0.30	0.40	0.50	0.45	0.55	0.65	0.40	0.50	0.60												
L1	-	-	-	-	-	-	-	-	-	-	-	-	-	-	-	0.30	0.40	0.50									
N	32			44			48			44			56														
ND	8			11			12			10			14														
NE	8			11			12			12			14														

PKG. CODES	DEPOPULATED LEADS	MIN.	NOM.	MAX.	MIN.	NOM.	MAX.	MIN.	NOM.	MAX.	MIN.	NOM.	MAX.	MIN.	NOM.	MAX.	JEDEC MO220 REV. C	DOWN BONDS ALLOWED
T3277-1	-	4.55	4.70	4.85	4.55	4.70	4.85	-	-	-	-	-	-	-	-	-	-	NO
T3277-2	-	4.55	4.70	4.85	4.55	4.70	4.85	-	-	-	-	-	-	-	-	-	-	YES
T4477-1	-	4.55	4.70	4.85	4.55	4.70	4.85	WKKD-1										NO
T4477-2	-	4.55	4.70	4.85	4.55	4.70	4.85	WKKD-1										YES
T4477-3	-	4.55	4.70	4.85	4.55	4.70	4.85	WKKD-1										YES
T4877-1**	13,24,37,48	4.20	4.30	4.40	4.20	4.30	4.40	-										NO
T4877-2	-	5.45	5.60	5.63	5.45	5.60	5.63	-										NO
T4877-3	-	4.95	5.10	5.25	4.95	5.10	5.25	-										YES
T4877-4	-	5.45	5.60	5.63	5.45	5.60	5.63	-										YES
T4877-5	-	2.40	2.50	2.60	2.40	2.50	2.60	-										NO
T4877-6	-	5.45	5.60	5.63	5.45	5.60	5.63	-										NO
T5677-1	-	5.20	5.30	5.40	5.20	5.30	5.40	-										YES

** NOTE: T4877-1 IS A CUSTOM 48L PKG. WITH 4 LEADS DEPOPULATED. TOTAL NUMBER OF LEADS ARE 44.

NOTES:

- DIMENSIONING & TOLERANCING CONFORM TO ASME Y14.5M-1994.
- ALL DIMENSIONS ARE IN MILLIMETERS. ANGLES ARE IN DEGREES.
- N IS THE TOTAL NUMBER OF TERMINALS.
- THE TERMINAL #1 IDENTIFIER AND TERMINAL NUMBERING CONVENTION SHALL CONFORM TO JESD 95-1 SPP-012. DETAILS OF TERMINAL #1 IDENTIFIER ARE OPTIONAL, BUT MUST BE LOCATED WITHIN THE ZONE INDICATED. THE TERMINAL #1 IDENTIFIER MAY BE EITHER A MOLD OR MARKED FEATURE.
- DIMENSION b APPLIES TO METALLIZED TERMINAL AND IS MEASURED BETWEEN 0.25 mm AND 0.30 mm FROM TERMINAL TIP.
- ND AND NE REFER TO THE NUMBER OF TERMINALS ON EACH D AND E SIDE RESPECTIVELY.
- DEPOPULATION IS POSSIBLE IN A SYMMETRICAL FASHION.
- COPLANARITY APPLIES TO THE EXPOSED HEAT SINK SLUG AS WELL AS THE TERMINALS.
- DRAWING CONFORMS TO JEDEC MO220 EXCEPT THE EXPOSED PAD DIMENSIONS OF T3277-1; T4877-1/-2/-3/-4/-5/-6 & T5677-1.
- WARPAGE SHALL NOT EXCEED 0.10 mm.

<small>PROPRIETARY INFORMATION</small>	
TITLE: PACKAGE OUTLINE 32, 44, 48, 56L THIN QFN, 7x7x0.8mm	
APPROVAL:	DOCUMENT CONTROL NO: 21-0144
REV: D	2/2

15W, Filterless, Spread-Spectrum, Mono/Stereo, Class D Amplifiers

Package Information (continued)

(The package drawing(s) in this data sheet may not reflect the most current specifications. For the latest package outline information, go to www.maxim-ic.com/packages.)

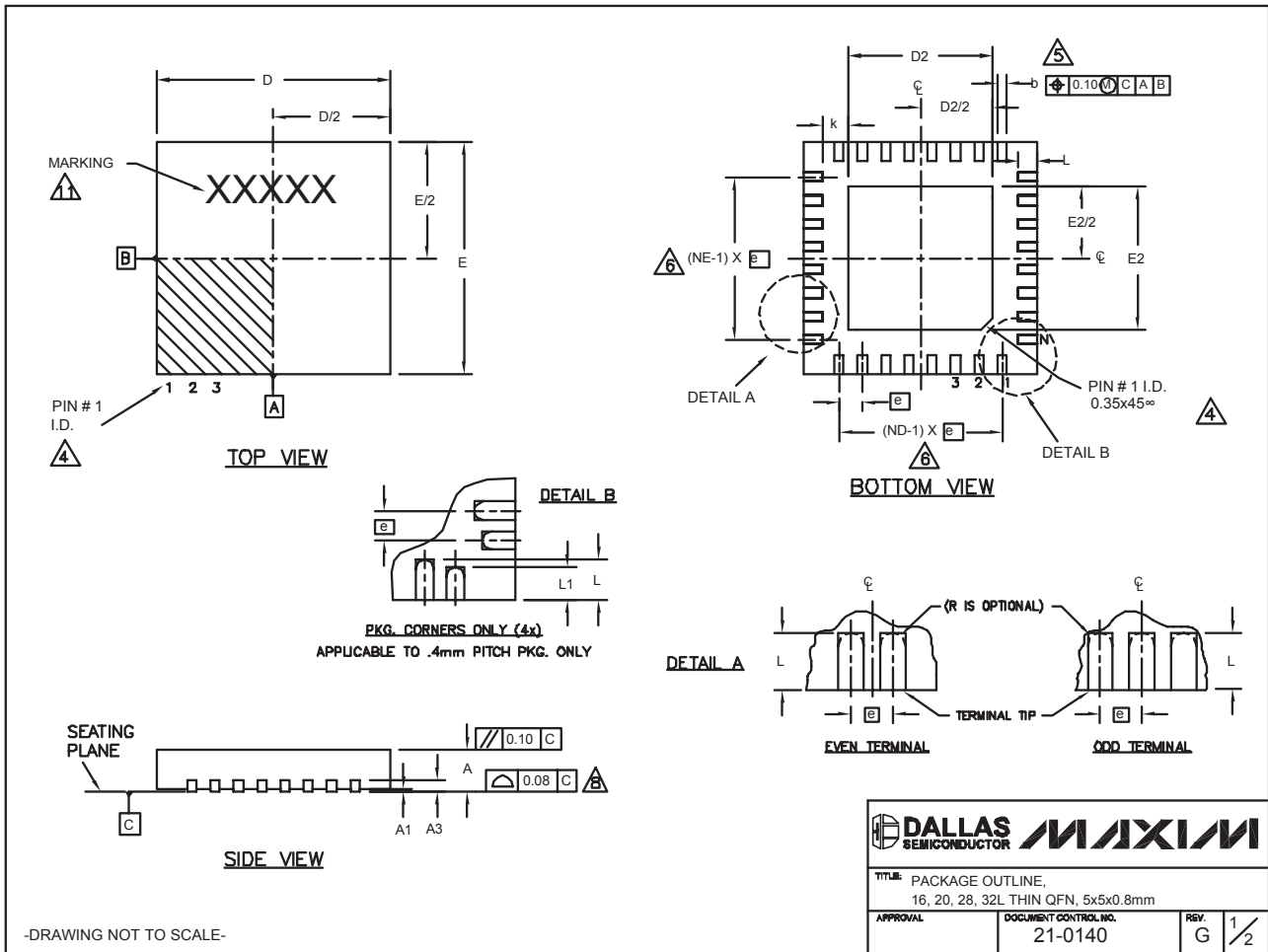

QFN THIN.EPS

-DRAWING NOT TO SCALE-

15W, Filterless, Spread-Spectrum, Mono/Stereo, Class D Amplifiers

Package Information (continued)

(The package drawing(s) in this data sheet may not reflect the most current specifications. For the latest package outline information, go to www.maxim-ic.com/packages.)

MAX9703/MAX9704

COMMON DIMENSIONS												
PKG.	16L 5x5			20L 5x5			28L 5x5			32L 5x5		
SYMBOL	MIN.	NOM.	MAX.	MIN.	NOM.	MAX.	MIN.	NOM.	MAX.	MIN.	NOM.	MAX.
A	0.70	0.75	0.80	0.70	0.75	0.80	0.70	0.75	0.80	0.70	0.75	0.80
A1	0	0.02	0.05	0	0.02	0.05	0	0.02	0.05	0	0.02	0.05
A3	0.20 REF.			0.20 REF.			0.20 REF.			0.20 REF.		
b	0.25	0.30	0.35	0.25	0.30	0.35	0.20	0.25	0.30	0.20	0.25	0.30
D	4.90	5.00	5.10	4.90	5.00	5.10	4.90	5.00	5.10	4.90	5.00	5.10
E	4.90	5.00	5.10	4.90	5.00	5.10	4.90	5.00	5.10	4.90	5.00	5.10
e	0.80 BSC.			0.65 BSC.			0.50 BSC.			0.50 BSC.		
k	0.25	-	-	0.25	-	-	0.25	-	-	0.25	-	-
L	0.30	0.40	0.50	0.45	0.55	0.65	0.45	0.55	0.65	0.30	0.40	0.50
L1	-	-	-	-	-	-	-	-	-	-	-	-
N	16			20			28			32		
ND	4			5			7			8		
NE	4			5			7			8		
JEDEC	WHHB			WHHC			WHHD-1			WHHD-2		

EXPOSED PAD VARIATIONS									
PKG. CODES	D2			E2			L ±0.15	DOWN BONDS ALLOWED	
	MIN.	NOM.	MAX.	MIN.	NOM.	MAX.			
T1655-1	3.00	3.10	3.20	3.00	3.10	3.20	**	NO	
T1655-2	3.00	3.10	3.20	3.00	3.10	3.20	**	YES	
T1655N-1	3.00	3.10	3.20	3.00	3.10	3.20	**	NO	
T2055-2	3.00	3.10	3.20	3.00	3.10	3.20	**	NO	
T2055-3	3.00	3.10	3.20	3.00	3.10	3.20	**	YES	
T2055-4	3.00	3.10	3.20	3.00	3.10	3.20	**	NO	
T2055-5	3.15	3.25	3.35	3.15	3.25	3.35	0.40	Y	
T2855-1	3.15	3.25	3.35	3.15	3.25	3.35	**	NO	
T2855-2	2.60	2.70	2.80	2.60	2.70	2.80	**	NO	
T2855-3	3.15	3.25	3.35	3.15	3.25	3.35	**	YES	
T2855-4	2.60	2.70	2.80	2.60	2.70	2.80	**	YES	
T2855-5	2.60	2.70	2.80	2.60	2.70	2.80	**	NO	
T2855-6	3.15	3.25	3.35	3.15	3.25	3.35	**	NO	
T2855-7	2.60	2.70	2.80	2.60	2.70	2.80	**	YES	
T2855-8	3.15	3.25	3.35	3.15	3.25	3.35	0.40	Y	
T2855N-1	3.15	3.25	3.35	3.15	3.25	3.35	**	N	
T3255-2	3.00	3.10	3.20	3.00	3.10	3.20	**	NO	
T3255-3	3.00	3.10	3.20	3.00	3.10	3.20	**	YES	
T3255-4	3.00	3.10	3.20	3.00	3.10	3.20	**	NO	
T3255N-1	3.00	3.10	3.20	3.00	3.10	3.20	**	NO	

**SEE COMMON DIMENSIONS TABLE

NOTES:

- DIMENSIONING & TOLERANCING CONFORM TO ASME Y14.5M-1994.
- ALL DIMENSIONS ARE IN MILLIMETERS. ANGLES ARE IN DEGREES.
- N IS THE TOTAL NUMBER OF TERMINALS.
- THE TERMINAL #1 IDENTIFIER AND TERMINAL NUMBERING CONVENTION SHALL CONFORM TO JEDEC 95-1 SPP-012. DETAILS OF TERMINAL #1 IDENTIFIER ARE OPTIONAL, BUT MUST BE LOCATED WITHIN THE ZONE INDICATED. THE TERMINAL #1 IDENTIFIER MAY BE EITHER A MOLD OR MARKED FEATURE.
- DIMENSION b APPLIES TO METALLIZED TERMINAL AND IS MEASURED BETWEEN 0.25 mm AND 0.30 mm FROM TERMINAL TIP.
- ND AND NE REFER TO THE NUMBER OF TERMINALS ON EACH D AND E SIDE RESPECTIVELY.
- DEPOPULATION IS POSSIBLE IN A SYMMETRICAL FASHION.
- COPLANARITY APPLIES TO THE EXPOSED HEAT SINK SLUG AS WELL AS THE TERMINALS.
- DRAWING CONFORMS TO JEDEC MO220, EXCEPT EXPOSED PAD DIMENSION FOR T2855-1, T2855-3 AND T2855-6.
- WARPAGE SHALL NOT EXCEED 0.10 mm.
- MARKING IS FOR PACKAGE ORIENTATION REFERENCE ONLY.
- NUMBER OF LEADS SHOWN ARE FOR REFERENCE ONLY.

-DRAWING NOT TO SCALE-

TITLE: PACKAGE OUTLINE, 16, 20, 28, 32L THIN QFN, 5x5x0.8mm	
APPROVAL	DOCUMENT CONTROL NO. 21-0140
REV. G	2/2

Maxim cannot assume responsibility for use of any circuitry other than circuitry entirely embodied in a Maxim product. No circuit patent licenses are implied. Maxim reserves the right to change the circuitry and specifications without notice at any time.

Maxim Integrated Products, 120 San Gabriel Drive, Sunnyvale, CA 94086 408-737-7600 19