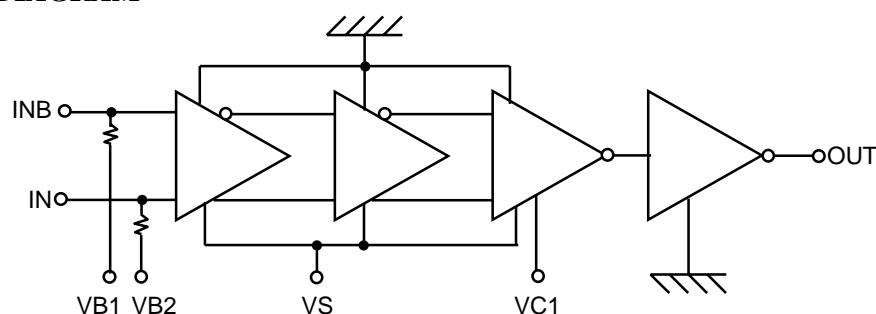

KGL4126F**10.7 Gbps Mach-Zehnder Modulator Driver IC****FEATURES**

- High Output Voltage: Maximum Amplitude > 5.0 Vpp
- X-Point Control Function
- Output Amplitude Control Function

FUNCTION DIAGRAM**ABSOLUTE MAXIMUM RATINGS**

Parameter	Symbol	Min	Max	Unit	Note
Supply Voltage	VS	-6.5	0.3	V	
X-Point Control Voltage	VB1	VS-4.5 (Min. -6.5)	VS+2.4 (Max. 0.3)	V	
Output Amplitude Control Voltage	VC1	-6.5	VS+1.2 (Max. 0.3)	V	
DC Bias for Output Stage Amplifier	VD	0	5.0	V	
Operating Temperature at Package Base	Ts	-10	100	°C	
Storage Temperature	Tst	-40	125	°C	

RECOMMENDED OPERATING CONDITIONS

Parameter	Symbol	Min	Typ	Max	Unit
Supply Voltage	VS	-5.46		-4.94	V
Supply Voltage ^{*1,2}	VD	2.0		3.5	V
X-Point Control Voltage	VB1	VS+0.8		VS+2.2	V
Output Amplitude Control Voltage ^{*1}	VC1	VS		VS+1.0	V
Operating Temperature at Package Base	Ts	0		85	°C
Input Interface	AC coupled (External blocking capacitor is required)				
Output Interface	AC coupled (External Bias-T is required for VD)				

*1 Output Amplitude can be controlled by VC1 and VD voltage. We recommend to control output amplitude by VD voltage. (VD is more effective than VC1.)

*2 VD is supplied at Output Port using External Bias-T.

ELECTRICAL CHARACTERISTICS

Parameter	Symbol	Condition	Min	Typ	Max	Unit
Input Data Rate		NRZ	10.7			Gbps
Supply Current of VS	I _{SS}			210	250	mA
Supply Current of VD	I _D	Supply DC Bias by Bias-T		70	100	mA
Input Amplitude	V _{in}	Differential (AC Coupled)	0.25		1	V _{pp}
		Single-Ended (AC Coupled)	0.5		1	V _{pp}
Output Amplitude (Max)	V _o (Max)	50 Ω load,(AC Coupled)	5.0			V _{pp}
X-Point Control	X _p	NRZ, 50 Ω load	40		60	%
Output Rise/Fall Time	T _r /T _f	50 Ω load 20%-80%			40	ps
Input Return Loss	S11	100kHz-10 GHz		13		dB

PACKAGE DIMENSIONS

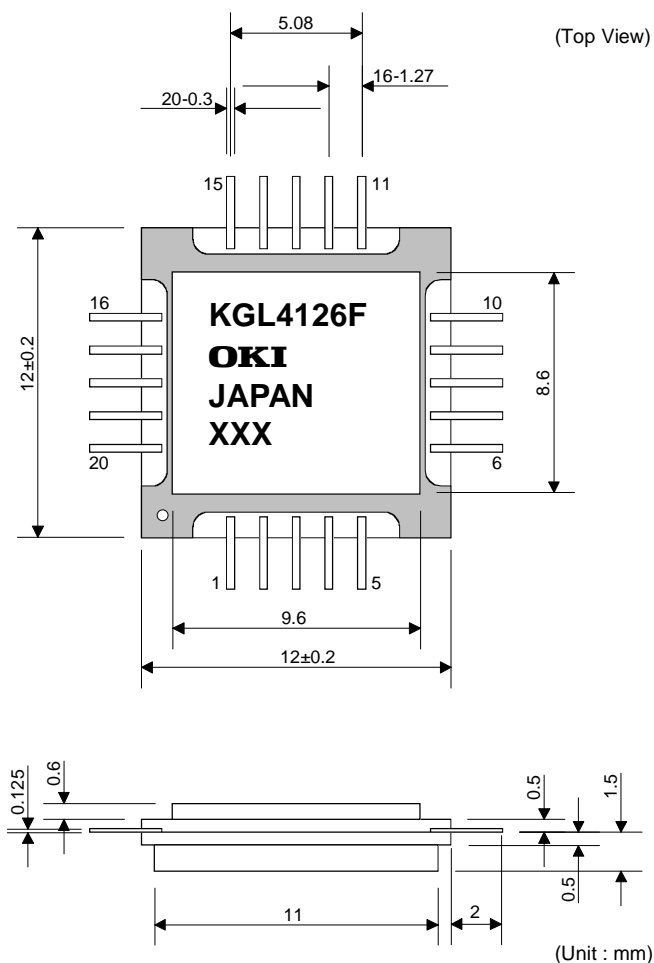

PINCONNECTION

No.	Symbol	Note
1	GND	Ground
2	GND	Ground
3	GND	Ground
4	GND	Ground
5	GND	Ground
6	GND	Ground
7	GND	Ground
8	GND	Ground
9	OUT.	Signal Output and DC Bias Port
10	GND	Ground
11	GND	Ground
12	VC1	Output Amplitude Control Port
13	VS	Supply Voltage Port
14	VB2	Input Termination Port
15	VB1	X-Point Control and Inverted Input Termination Port
16	GND	Ground
17	INB	Inverted Input Terminal
18	GND	Ground
19	IN	Signal Input Terminal
20	GND	Ground

AC CHARACTERISTICS TEST CIRCUIT

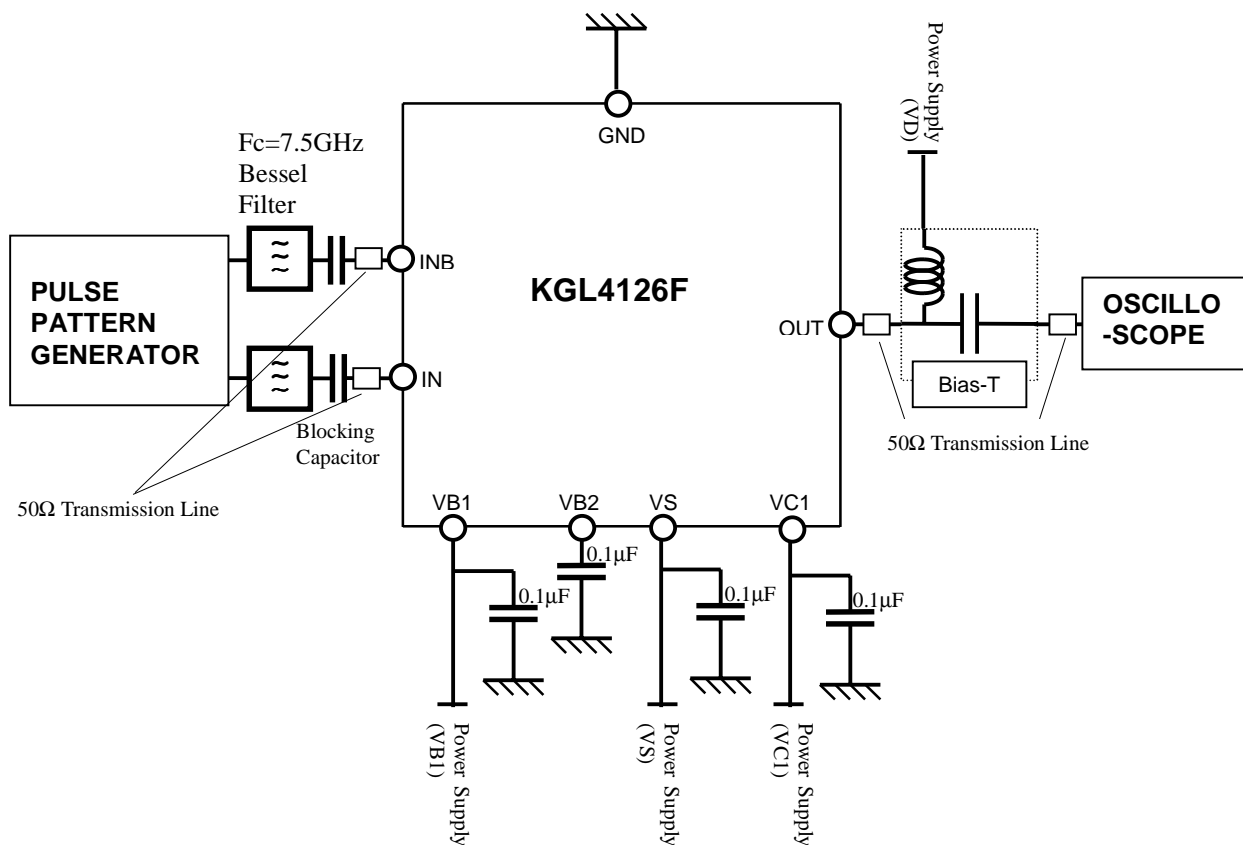

TYPICAL CHARACTERISTICS (WAVEFORM)

Measured Condition (@25°C)

Display Factor V : 1.0V/div, H : 20 ps/div, Offset : 0V
 Input Signal 10.7Gbps, NRZ, PN31, Differential 0.25Vpp, AC Coupled
 Tr/Tf(20-80%)≒40ps (through 7.5GHz Bessel Filters)

Waveform @10.7Gbps Operate

@4.0Vpp

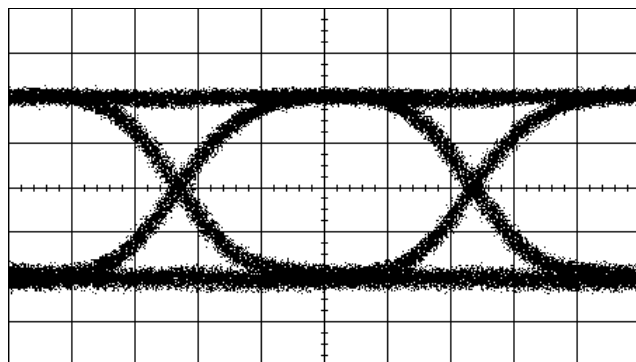

VS : -5.0V I_{ss} : 207.7mA
 VB1 : -3.75V Crossing-Point : 50.1%
 VC1 : -4.0V
 VD : 2.475V I_D : 52.4mA
 Power : 1.168W
 Amplitude: 4.003Vpp
 Tr : 27.6ps
 Tf : 27.1ps
 JitterP-P : 10.9ps

@4.5Vpp

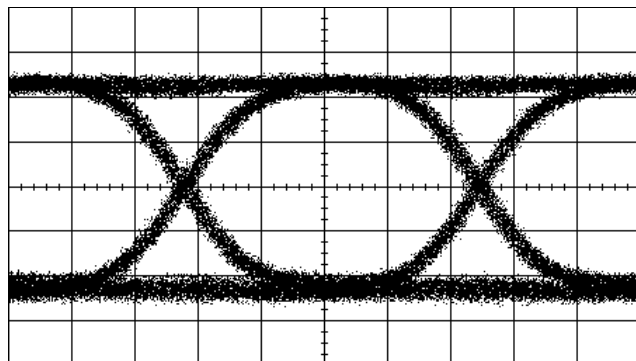

VS : -5.0V I_{ss} : 207.7mA
 VB1 : -3.74V Crossing-Point [%] : 50.2%
 VC1 : -4.0V
 VD : 2.83V I_D : 60.1mA
 Power : 1.208W
 Amplitude: 4.506Vpp
 Tr : 28.0ps
 Tf : 28.0ps
 JitterP-P : 10.8ps

@5.0Vpp

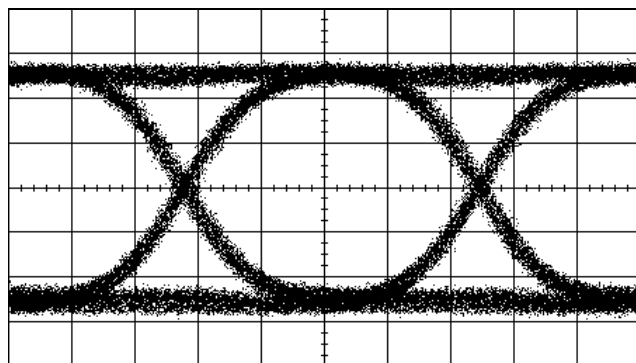

VS : -5.0V I_{ss} : 207.6mA
 VB1 : -3.74V Crossing-Point : 50.1%
 VC1 : -4.0V
 VD : 3.22V I_D : 67.3mA
 Power : 1.255W
 Amplitude: 5.005Vpp
 Tr : 29.3ps
 Tf : 28.4ps
 JitterP-P : 10.9ps

Note JitterP-P means “ 6 × Jitter(RMS) “.

TYPICAL CHARACTERISTICS (SUPPLY VOLTAGE DEPENDENCE : V_D)

Measured Condition (@25°C)

Input Signal 10.7Gbps NRZ PRBS31, Differential 0.25V_{pp}

V_S=-5.0V, V_{B1}@X_p≅50%, V_{C1}=-4.0V

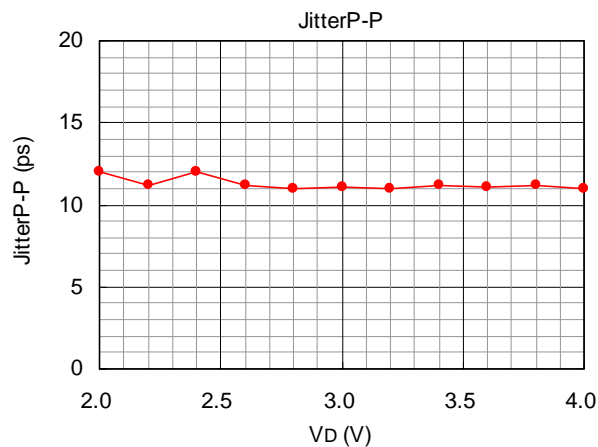
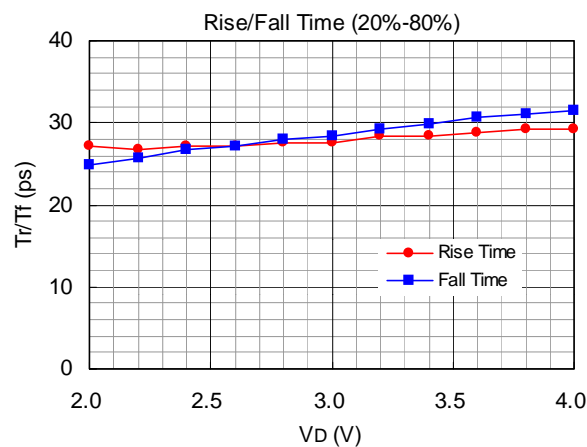
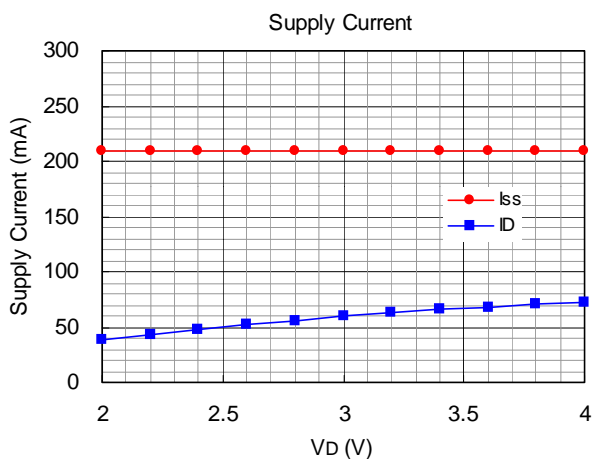
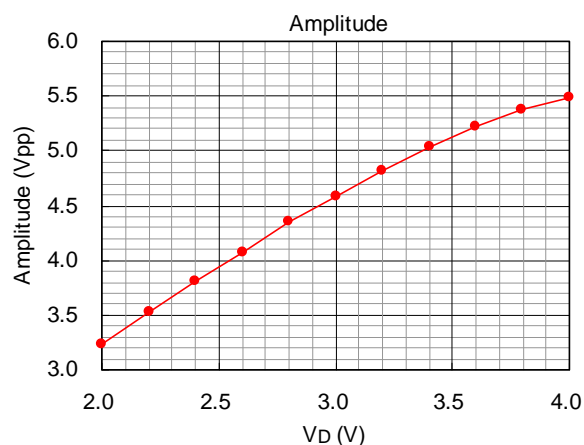

TYPICAL CHARACTERISTICS (SUPPLY VOLTAGE DEPENDENCE : VS)

Measured Condition (@25°C)

Input Signal 10.7Gbps NRZ PRBS31, Differential 0.25Vpp

VB1@Xp≅50%, VC1=-4.0V

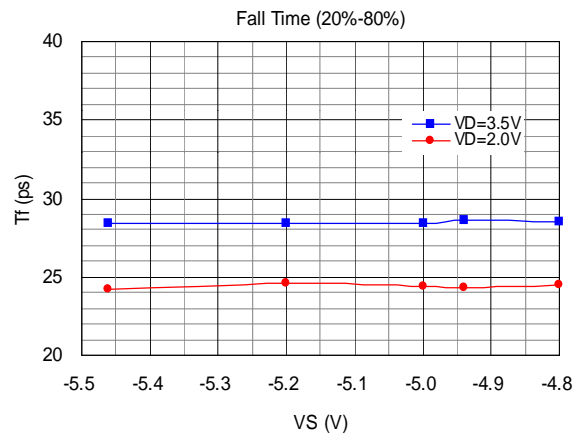
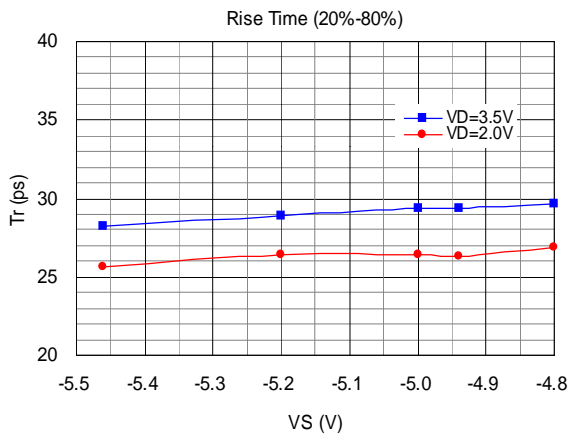
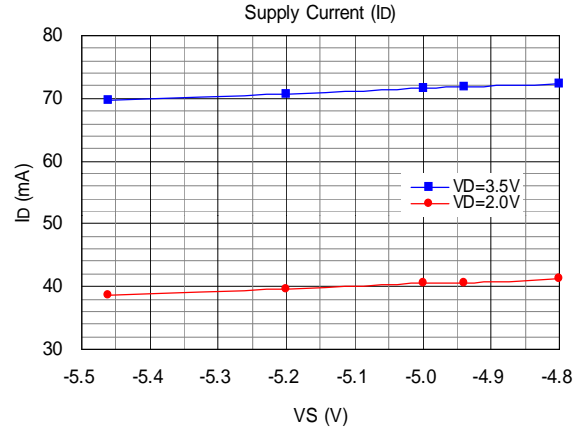
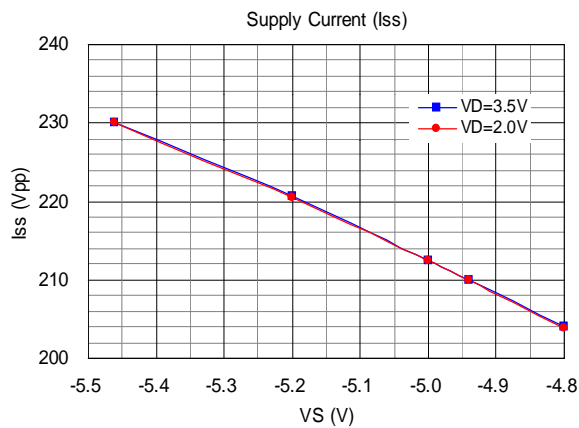
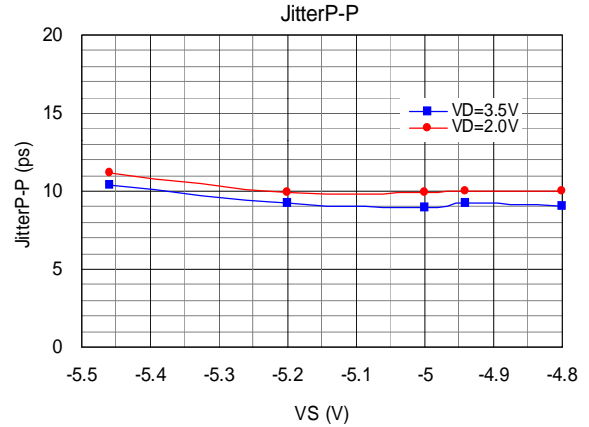
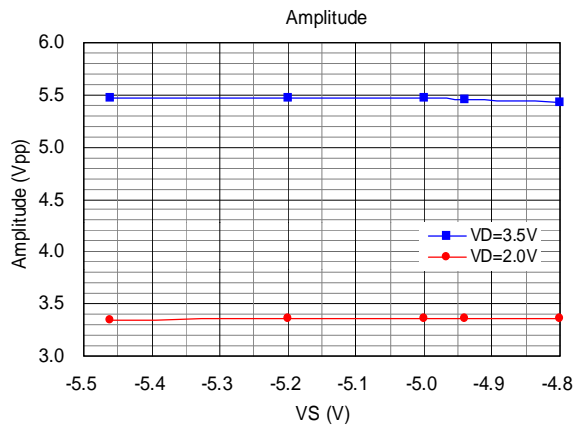

TYPICAL CHARACTERISTICS (TEMPERATURE CHARACTERISTICS)

Measured Condition

Input Signal 10.7Gbps NRZ PRBS31, Differential 0.25Vpp
 VS=-5V, VC1=-4.0V, VB1:Xp50% @25degC

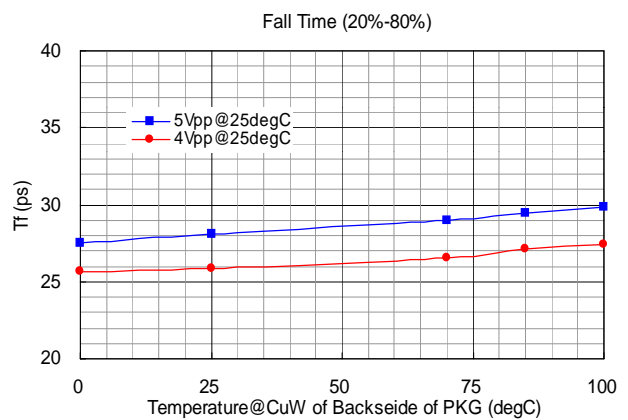
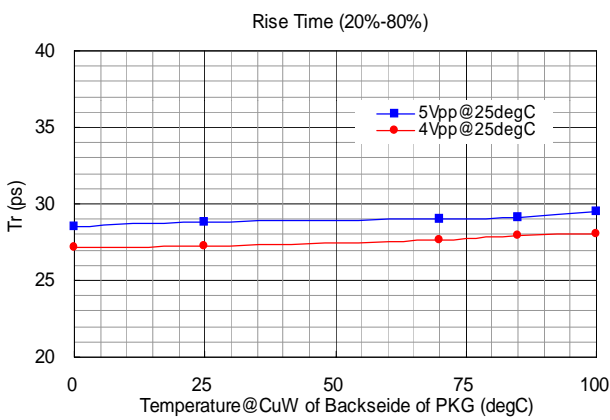
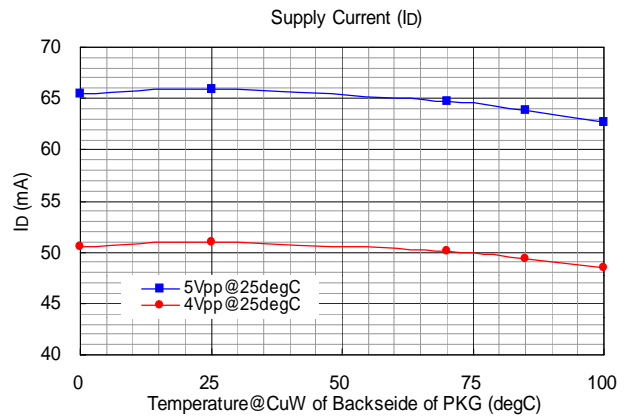
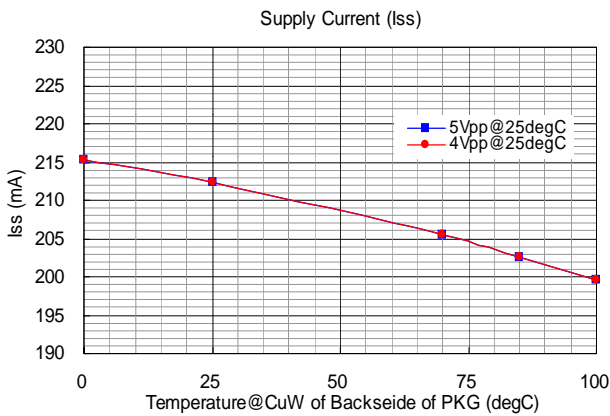
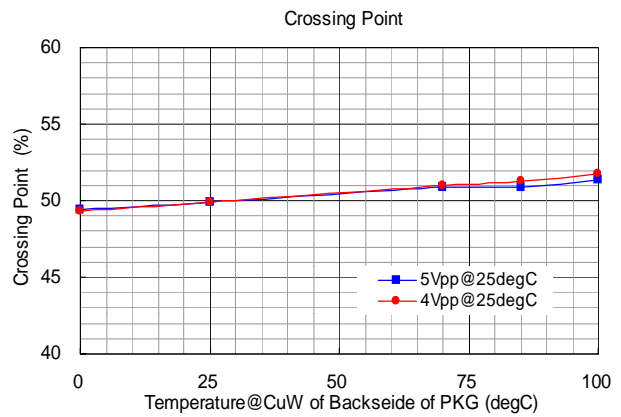
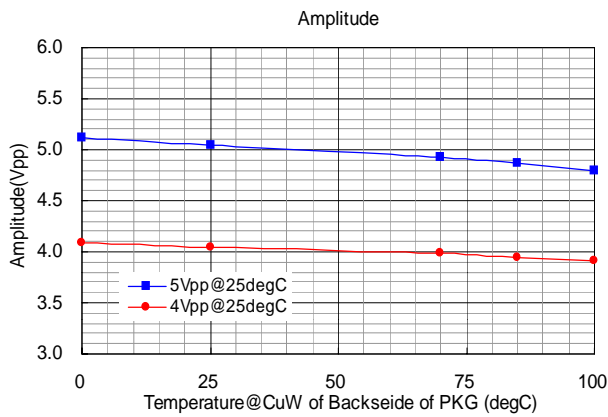

TYPICAL APPLICATION

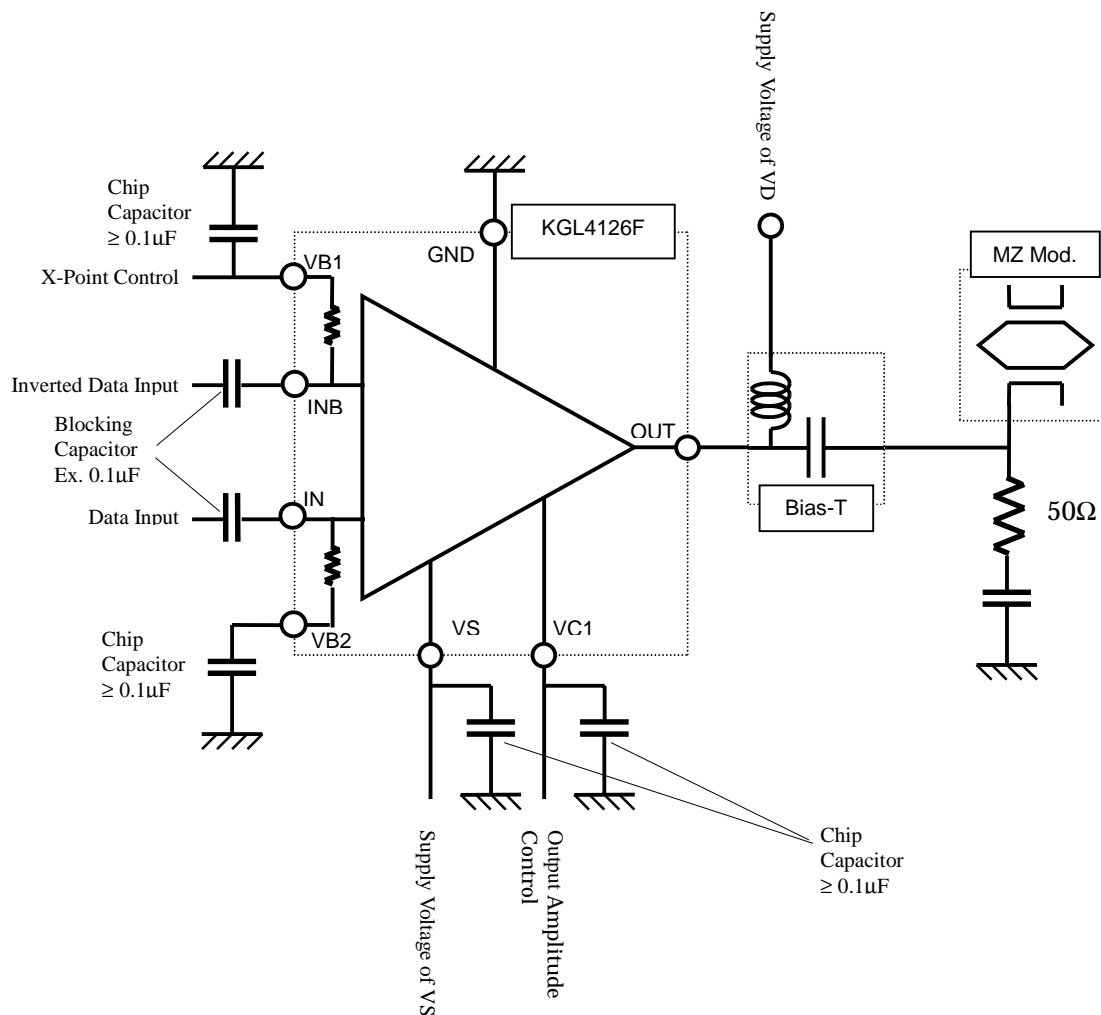

APPLICATION NOTE

1. For stable operation;
 - 1-1. To prevent a dependence of "X-Point" on the supply voltage VS,
 - (1) Use an external voltage source of -3.8V for "VB2", or
 - (2) Control the voltage of "VB1", so that the voltage difference "VB1-VB2" is constant.
 - 1-2. To prevent a dependence of "Output amplitude" on the supply voltage VS,
 Control the voltage of "VC1", so that the voltage difference "VC1-VS" is constant.
2. Power-up/shut-down sequence;
 For power-up, supply control voltages (VB1, (VB2), VC1) at first, next VS, then VD.
 For shut-down, VD at first, next VS, then control voltages.
 Customer does not need to care about the sequence for the control voltages (VB1,(VB2),VC1).

SAFETY AND HANDLING INFORMATION ON GaAs DEVICES

Arsenic Compound (GaAs Devices)

The product contains arsenic (As) as a compound.

This material is stable for normal use, however, its dust or vapor may be potentially hazardous to the human body.

Avoid ingestion, fracture, burning or chemical treatment to the product.

- Do not put the product in your mouth.
- Do not burn or destroy the product.
- Do not perform chemical treatment for the product.

Keep laws and ordinances related to the disposal of the products.

NOTICE

1. The information contained herein can change without notice owing to product and/or technical improvements. Before using the product, please make sure that the information being referred to is up-to-date.
2. The outline of action and examples for application circuits described herein have been chosen as an explanation for the standard action and performance of the product. When planning to use the product, please ensure that the external conditions are reflected in the actual circuit, assembly, and program designs.
3. When designing your product, please use our product below the specified maximum ratings and within the specified operating ranges including, but not limited to, operating voltage, power dissipation, and operating temperature.
4. Oki assumes no responsibility or liability whatsoever for any failure or unusual or unexpected operation resulting from misuse, neglect, improper installation, repair, alteration or accident, improper handling, or unusual physical or electrical stress including, but not limited to, exposure to parameters beyond the specified maximum ratings or operation outside the specified operating range.
5. Neither indemnity against nor license of a third party's industrial and intellectual property right, etc. is granted by us in connection with the use of the product and/or the information and drawings contained herein. No responsibility is assumed by us for any infringement of a third party's right which may result from the use thereof.
6. The products listed in this document are intended for use in general electronics equipment for commercial applications (e.g., office automation, communication equipment, measurement equipment, consumer electronics, etc.). These products are not authorized for use in any system or application that requires special or enhanced quality and reliability characteristics nor in any system or application where the failure of such system or application may result in the loss or damage of property, or death or injury to humans. Such applications include, but are not limited to, traffic and automotive equipment, safety devices, aerospace equipment, nuclear power control, medical equipment, and life-support systems.
7. Certain products in this document may need government approval before they can be exported to particular countries. The purchaser assumes the responsibility of determining the legality of export of these products and will take appropriate and necessary steps at their own expense for these.
8. No part of the contents contained herein may be reprinted or reproduced without our prior permission.

Copyright 2002 Oki Electric Industry Co., Ltd.