

Typical Applications

The HMC668LP3(E) is ideal for:

- Cellular/3G and LTE/WiMAX/4G
- BTS & Infrastructure
- Repeaters and Femtocells
- Tower Mounted Amplifiers
- Test & Measurement Equipment

Features

- Noise Figure: 0.9 dB
- Output IP3: +33 dBm
- Gain: 16 dB
- Failsafe Operation:
 - Bypass is enabled when LNA is unpowered
- Single Supply: +3V or +5V
- 16 Lead 3x3mm QFN Package: 9 mm²

Functional Diagram

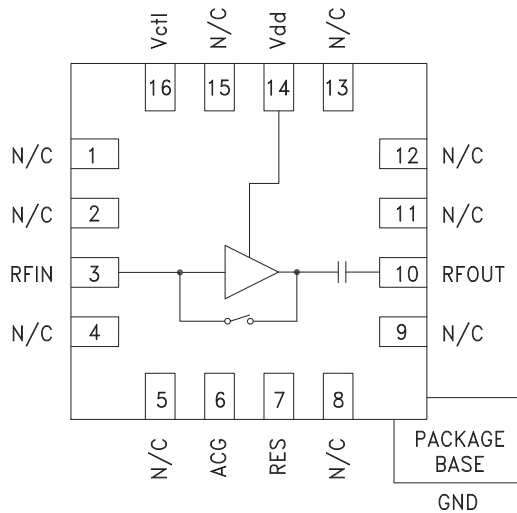

General Description

The HMC668LP3(E) is a versatile, high dynamic range GaAs MMIC Low Noise Amplifier that integrates a low loss LNA bypass mode on the IC. The amplifier is ideal for receivers and LNA modules operating between 0.7 and 1.2 GHz and provides 0.9 dB noise figure, 16 dB of gain and +33 dBm IP3 from a single supply of +5V @ 57mA. Input and output return losses are excellent and no external matching components are required. A single control line is used to switch between LNA mode and a low loss bypass mode. The failsafe topology enables the LNA bypass path, when no DC power is available. The HMC668LP3(E) offers improved noise figure versus the previously released HMC373LP3(E).

Electrical Specifications, $T_A = +25^\circ\text{C}$, $R_{bias} = 0\ \Omega$

Parameter	LNA Mode						Bypass Mode			Failsafe Mode			Units
	Vdd = +3V			Vdd = +5V			Min.	Typ.	Max.	Min.	Typ.	Max.	
	Min.	Typ.	Max.	Min.	Typ.	Max.							
Frequency Range	0.7 - 1.2			0.7 - 1.2			0.7 - 1.2			0.7 - 1.2			GHz
Gain	12	15		13	16		-2.5	-1.5		-2.5	-1.5		dB
Gain Variation Over Temperature		0.03			0.016			0.0008			0.0008		dB / °C
Noise Figure		0.85	1.1		0.9	1.1							dB
Input Return Loss		12			13			12			12		dB
Output Return Loss		13			14			13			13		dB
Reverse Isolation		22			23			-			-		dB
Power for 1dB Compression (P1dB) ^[1]		13			13			22			24		dBm
Third Order Intercept (IP3) ^[2]		27			33			26			26		dBm
Supply Current (Idd)		32	40		57	70		0.05			-		mA
Switching Speed (90% -10%)								200			-		ns
LNA Mode to Bypass Mode													ns
Bypass Mode to LNA Mode		85			85								ns

[1] P1dB for LNA Mode is referenced to RFOUT while P1dB for Bypass and Failsafe Modes are referenced to RFIN.

[2] IP3 for LNA Mode is referenced to RFOUT while IP3 for Bypass and Failsafe Modes are referenced to RFIN.

LNA - Broadband Gain & Return Loss

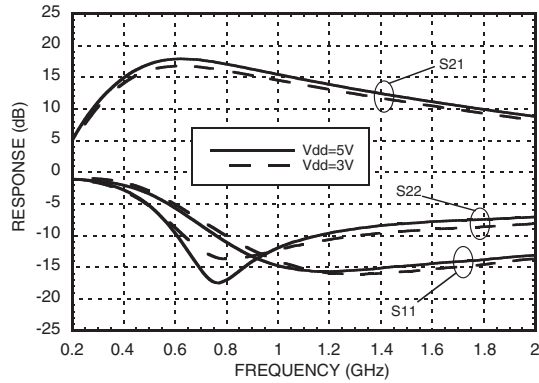

LNA - Gain vs. Temperature [1]

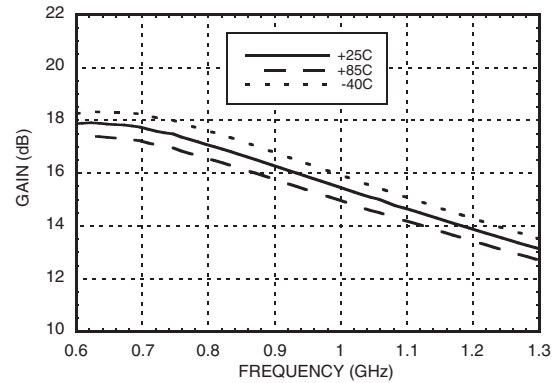

LNA - Gain vs. Temperature [2]

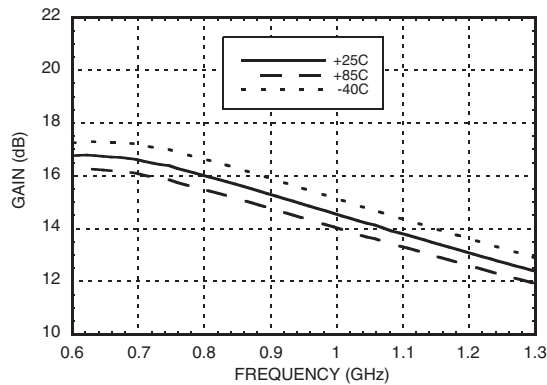

LNA - Return Loss vs. Temperature [1]

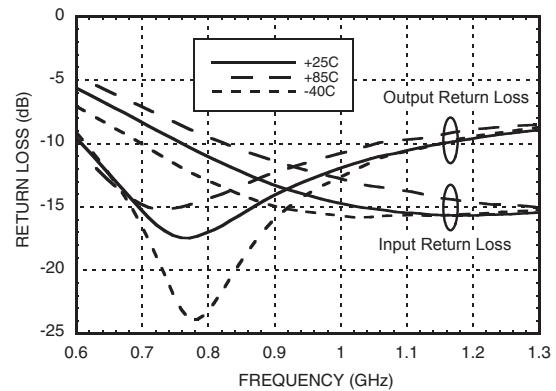

LNA - Noise Figure vs. Temperature [3]

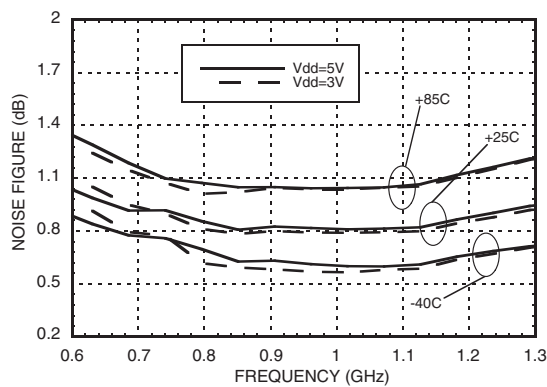

LNA - Output IP3 vs. Temperature, Output Power @ 0 dBm

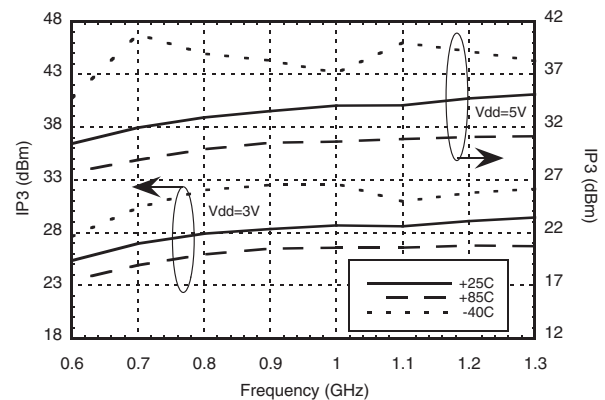

[1] Vdd = 5V [2] Vdd = 3V [3] Measurement reference plane shown on evaluation PCB drawing.

LNA - Output P1dB vs. Temperature [1]

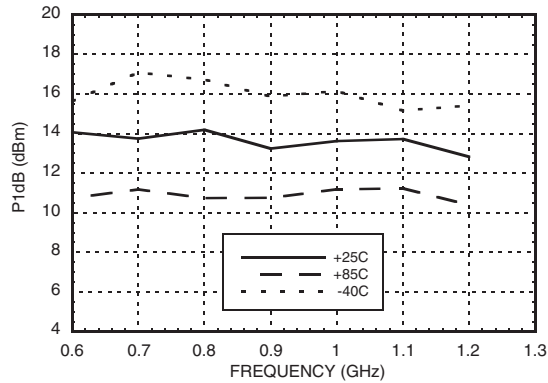

LNA - Output P1dB vs. Temperature [2]

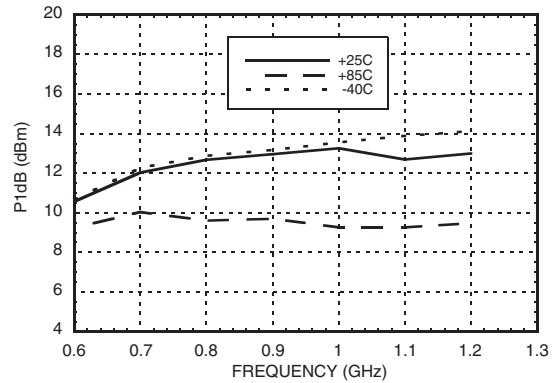

LNA - Gain, P1dB, Output IP3 vs. Current [1] @ 900 MHz

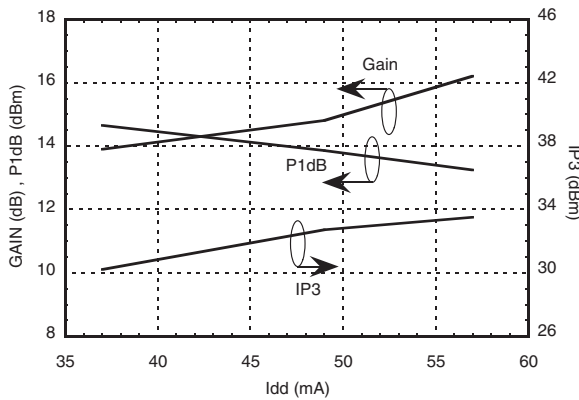

LNA - Gain, P1dB, Output IP3 vs. Current [2] @ 900 MHz

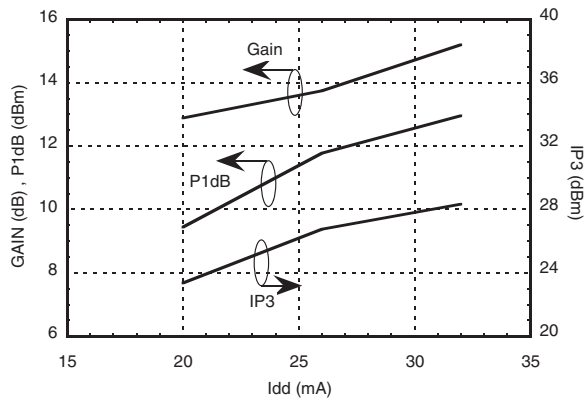

LNA - Reverse Isolation vs. Temperature [1]

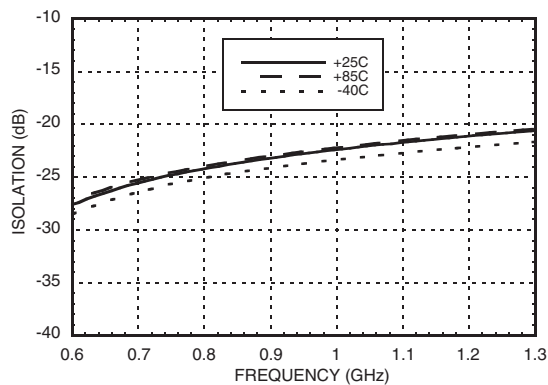

LNA - Output P1dB, Gain & Noise Figure [3] vs. Vdd @ 900 MHz

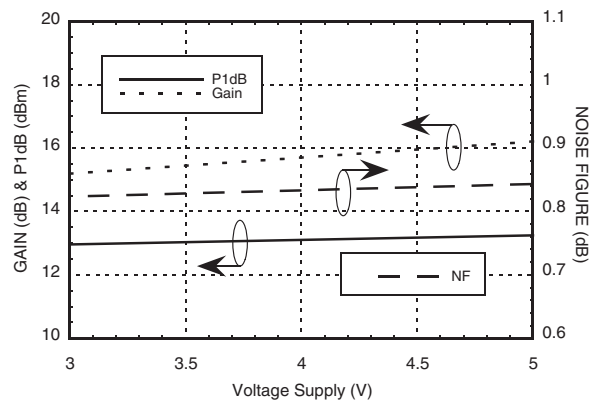

[1] Vdd = 5V [2] Vdd = 3V [3] Measurement reference plane shown on evaluation PCB drawing.

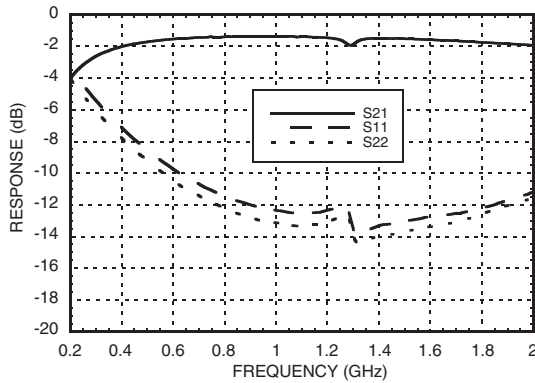
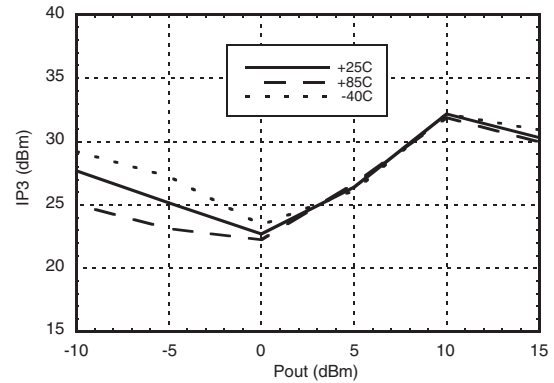
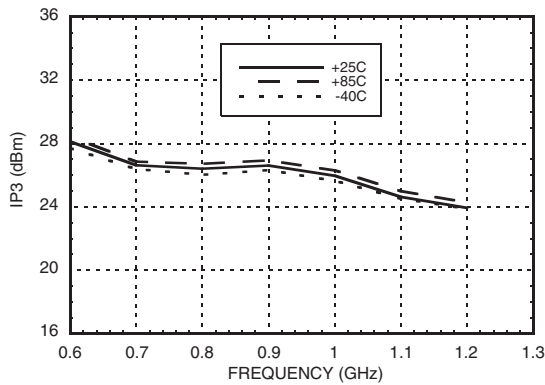
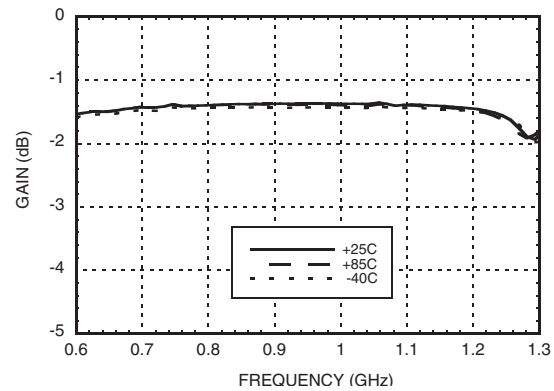
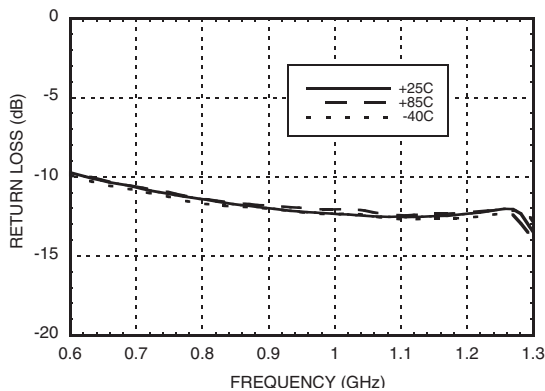
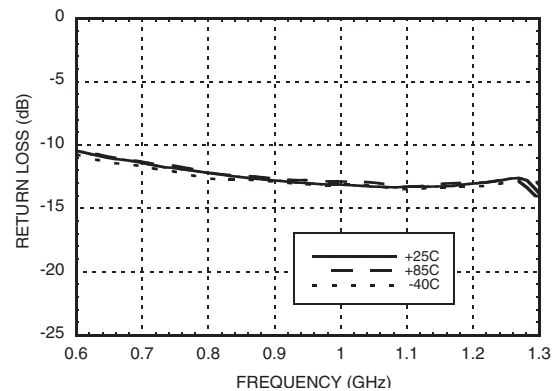
**Bypass Mode -
Broadband Gain & Return Loss**

**Bypass Mode -
Input IP3 vs. Output Power @ 900 MHz**

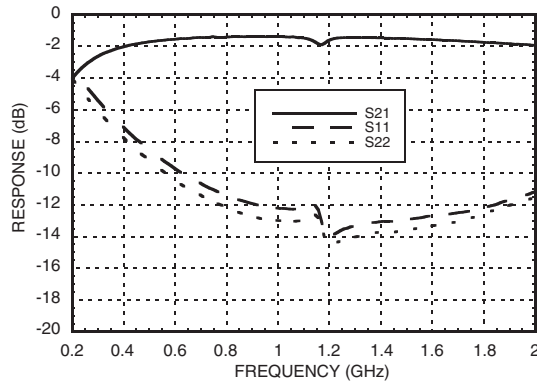
**Bypass Mode - Input IP3 vs. Temperature,
Output Power @ 5 dBm**

**Bypass Mode -
Insertion Loss vs. Temperature**

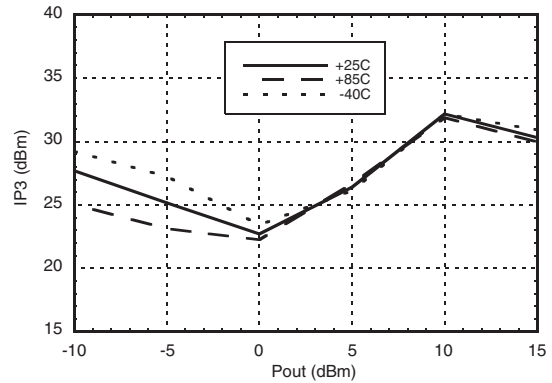
**Bypass Mode -
Input Return Loss vs. Temperature**

**Bypass Mode -
Output Return Loss vs. Temperature**

**Failsafe Mode -
Broadband Gain & Return Loss**



**Failsafe Mode -
Input IP3 vs. Output Power @ 900 MHz**



**Failsafe Mode - Input IP3 vs.
Temperature, Output Power @ 5 dBm**

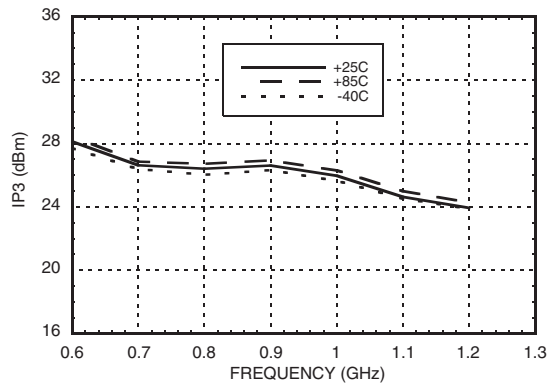

**Failsafe Mode -
Insertion Loss vs. Temperature**

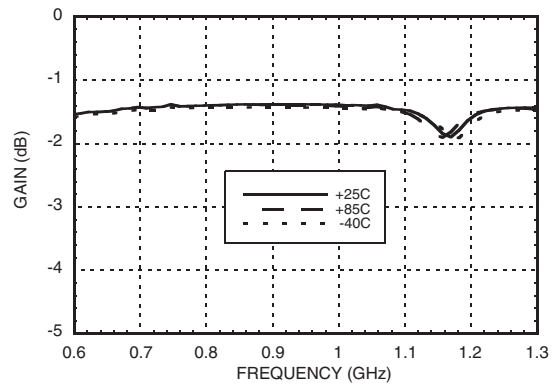

**Failsafe Mode -
Input Return Loss vs. Temperature**

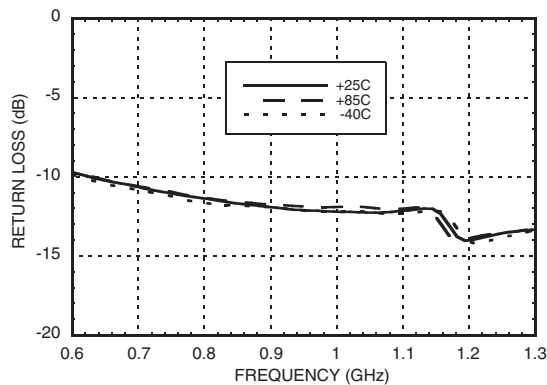

**Failsafe Mode -
Output Return Loss vs. Temperature**

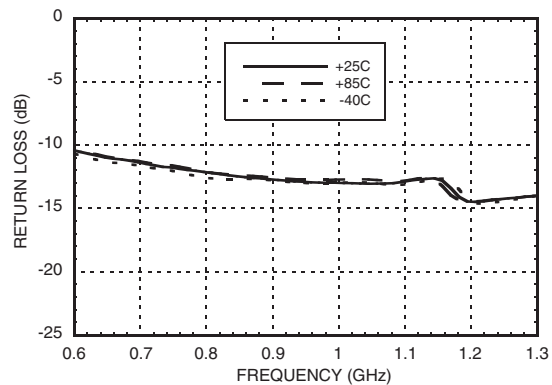

Absolute Maximum Ratings

Drain Bias Voltage (Vdd)	+6 Vdc
Control Voltage (Vctl)	+6 Vdc
RF Input Power (RFIN)	LNA Mode +5 dBm Bypass / Failsafe Mode +20 dBm
Channel Temperature	150 °C
Continuous Pdiss (T = 85 °C) (derate 10.71 mW/°C above 85 °C)	0.70 W
Thermal Resistance (channel to ground paddle)	93.33 °C/W
Storage Temperature	-65 to +150° C
Operating Temperature	-40 to +85° C
ESD Sensitivity (HBM)	Class 1A



**ELECTROSTATIC SENSITIVE DEVICE
OBSERVE HANDLING PRECAUTIONS**

Typical Supply Current vs. Vdd

Rbias Ω	Idd (mA)	
	Vdd= 3V	Vdd= 5V
0	32	57
15	26	49
47	20	37
180 [1]	10	20

[1] Recommended maximum Rbias

Truth Table

LNA Mode	Vctl = Vdd = 3 to 5V
Bypass Mode	Vctl= 0V, Vdd = 3 to 5V
Failsafe Mode	Vctl = Vdd = N/C



Outline Drawing

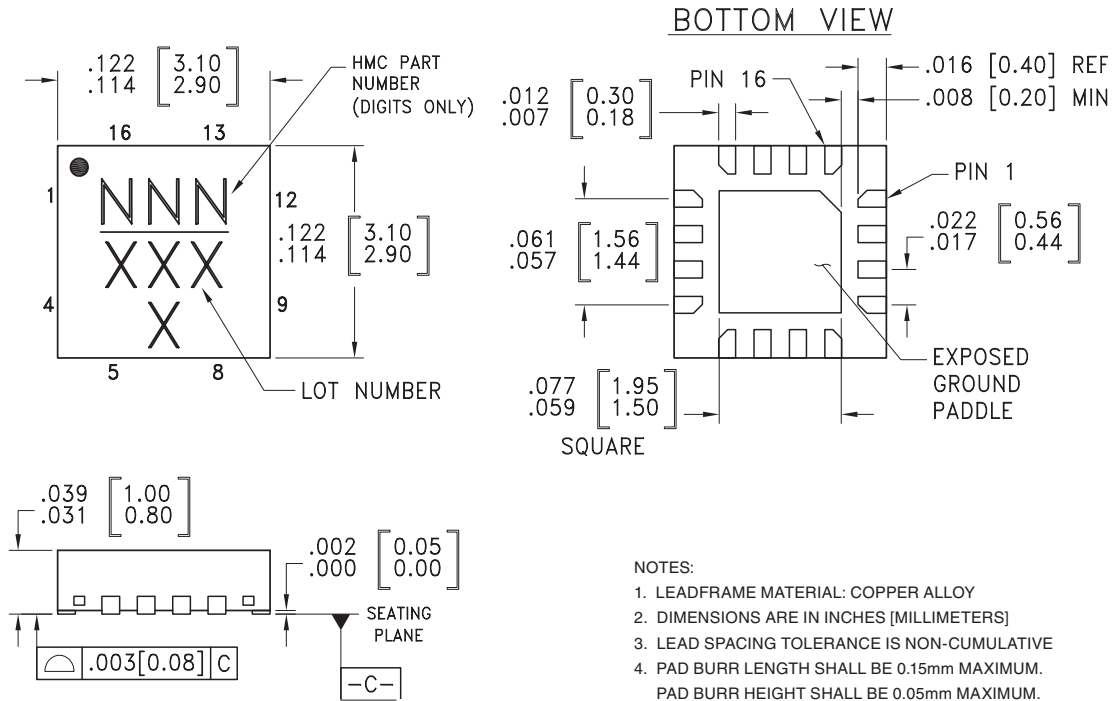

NOTES:

1. LEADFRAME MATERIAL: COPPER ALLOY
2. DIMENSIONS ARE IN INCHES [MILLIMETERS]
3. LEAD SPACING TOLERANCE IS NON-CUMULATIVE
4. PAD BURR LENGTH SHALL BE 0.15mm MAXIMUM. PAD BURR HEIGHT SHALL BE 0.05mm MAXIMUM.
5. PACKAGE WARP SHALL NOT EXCEED 0.05mm.
6. ALL GROUND LEADS AND GROUND PADDLE MUST BE SOLDERED TO PCB RF GROUND.
7. REFER TO HITTITE APPLICATION NOTE FOR SUGGESTED LAND PATTERN.

Package Information

Part Number	Package Body Material	Lead Finish	MSL Rating	Package Marking ^[3]
HMC668LP3	Low Stress Injection Molded Plastic	Sn/Pb Solder	MSL1 ^[1]	668 XXXX
HMC668LP3E	RoHS-compliant Low Stress Injection Molded Plastic	100% matte Sn	MSL1 ^[2]	668 XXXX

[1] Max peak reflow temperature of 235 °C

[2] Max peak reflow temperature of 260 °C

[3] 4-Digit lot number XXXX

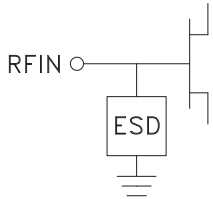
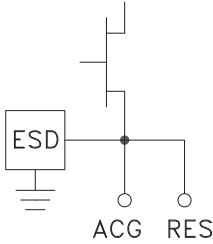
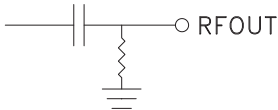
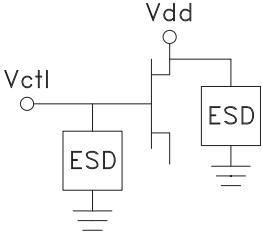

Pin Descriptions

Pin Number	Function	Description	Interface Schematic
1, 2, 4, 5, 8, 9, 11, 12, 13, 15	N/C	No connection required. These pins may be connected to RF GND. Performance will not be affected.	
3	RFIN	This pin is DC coupled. Off-chip DC blocking capacitor required.	
6	ACG	AC Ground. Attach bypass capacitor per application circuit.	
7	RES	External resistor pin for current control. See table for external resistor value vs. bias current data.	
10	RFOUT	This pin is matched to 50 Ohms	
14	Vdd	Power Supply voltage pin. External bypass capacitors required.	
16	Vctl	Control voltage pin for LNA / Bypass Modes. Setting voltage equal to VDD enables LNA Mode. External Bypass capacitor required.	



Application Circuit

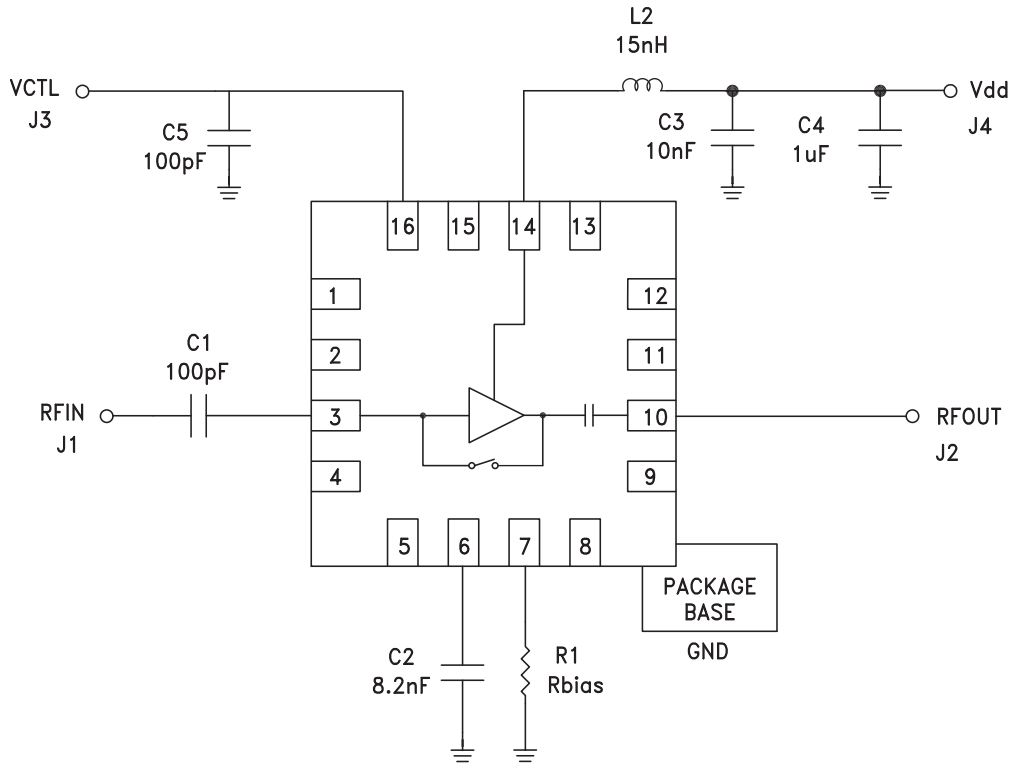

Evaluation PCB

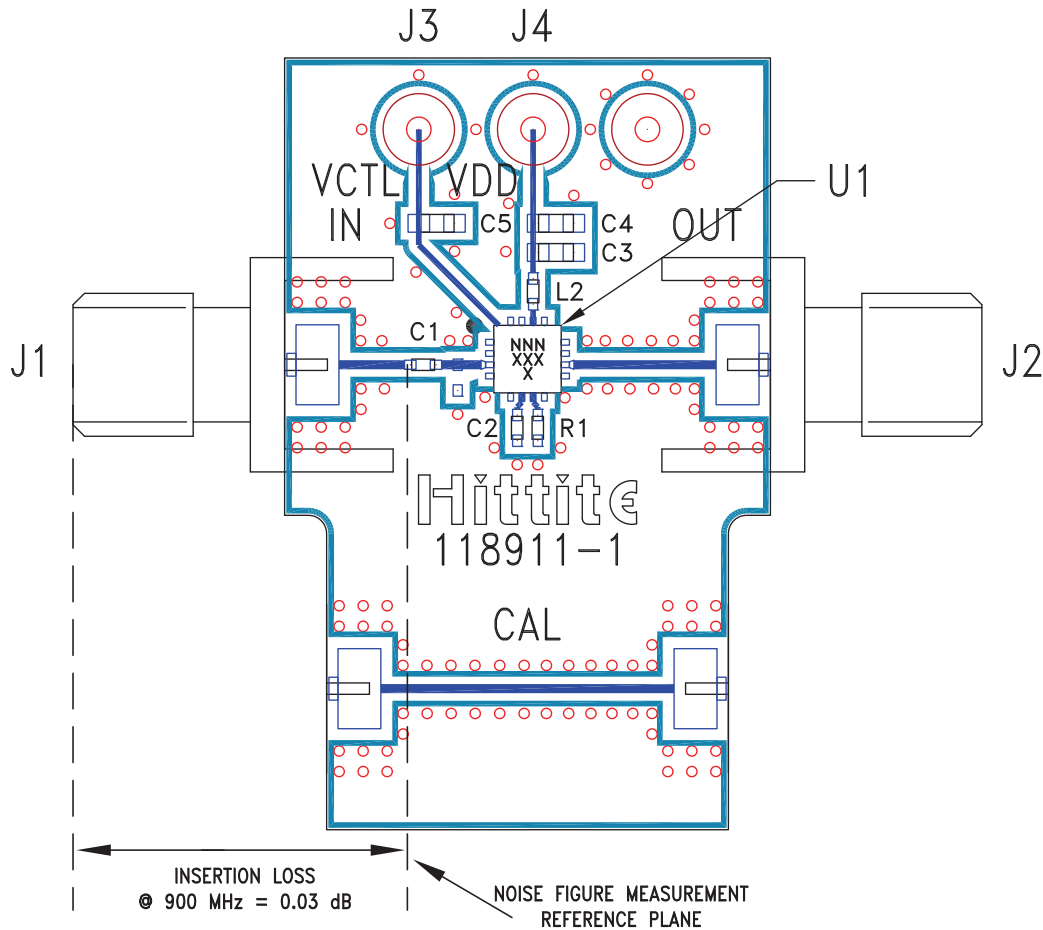

List of Materials for Evaluation PCB 121922 [1]

Item	Description
J1 - J2	PCB Mount SMA Connector
J3 - J4	DC Pin
C1	100 pF Capacitor, 0402 Pkg.
C2	8200 pF Capacitor, 0402 Pkg.
C3	10 nF Capacitor, 0603 Pkg.
C4	1 μF Capacitor, 0603 Pkg.
C5	100 pF Capacitor, 0603 Pkg.
L2	15 nH Inductor, 0402 Pkg.
R1	0 Ohm Resistor, 0402 Pkg.
U1	HMC668LP3(E) Amplifier
PCB [2]	118911 Evaluation Board

The circuit board used in the application should use RF circuit design techniques. Signal lines should have 50 Ohm impedance while the package ground leads and exposed paddle should be connected directly to the ground plane similar to that shown. A sufficient number of via holes should be used to connect the top and bottom ground planes. The evaluation circuit board shown is available from Hittite upon request.

[1] Reference this number when ordering complete evaluation PCB

[2] Circuit Board Material: Rogers 4350