

Secondary LDO Regulators

# Secondary Fixed Output LDO Regulators

BA□□JC5 Series



# Secondary Variable Output LDO Regulator

BA00JC5WT

No.11024EBT03

**●Description**

The BA□□JC5 are low-saturation regulators with an output current of 1.5 A and a voltage accuracy of  $\pm 1\%$ . A broad output voltage range is offered, from 1.5V to 12V, and built-in overcurrent protection and thermal shutdown (TSD) circuits prevent damage due to short-circuiting and overloading, respectively.

**●Features**

- 1) Output current: 1.5A (min.)
- 2) Output voltage accuracy:  $\pm 1\%$
- 3) Broad output voltage range available: 1.5V -12V (BA□□JC5 series)
- 4) Low saturation-voltage type with PNP output
- 5) Built-in overcurrent protection circuit
- 6) Built-in thermal shutdown circuit
- 7) Integrated shutdown switch (BA□□JC5WT)
- 8) Operating temperature range:  $-40^{\circ}\text{C}$  to  $+105^{\circ}\text{C}$

**●Applications**

All electronic devices that use microcontrollers and logic circuits

●Product Lineup

Part Number	1.5	1.8	2.5	3.0	3.3	5.0	6.0	6.3	8.0	9.0	12.0	Variable	Package
BA□□JC5T	○	○	○	○	○	○	○	○	○	○	○	-	TO220FP-3
BA□□JC5WT	-	-	-	-	-	-	-	-	-	-	-	○	TO220FP-5 (V5)

Part Number: BA□□JC5□ □  
 a            b    c

Symbol	Description			
a	Output voltage specification			
	□□	Output voltage (V)	□□	Output voltage (V)
	15	1.5 V typ	60	6.0 V typ
	18	1.8 V typ	63	6.3 V typ
	25	2.5 V typ	80	8.0 V typ
	30	3.0 V typ	90	9.0 V typ
	33	3.3 V typ	J2	12.0 V typ
	50	5.0 V typ	00	Variable
b	Existence of switch	With W: A shutdown switch is provided. Without W: No shutdown switch is provided.		
c	Package T:	TO20FP-5, TO220FP-5·V5, TO220FP-3		

●Absolute Maximum Ratings (Ta = 25°C)

Parameter	Symbol	Ratings	Unit
Power supply voltage	Vcc	18*1	V
Power dissipation	TO220FP-3	Pd	2000*2
	TO220FP-5		2000*2
	TO220FP-5·V5		2000*2
Operating temperature range	Topr	-40 to +105	°C
Ambient storage temperature	Tstg	-55 to +150	°C
Maximum junction temperature	Tjmax	150	°C

\*1 Must not exceed Pd  
 \*2 Derated at 16mW/°C at Ta>25°C

●Recommended Operating Conditions

Parameter	Symbol	Ratings		Unit
		Min.	Max.	
Input power supply voltage	Vcc*3	3.0	16.0	V
Input power supply voltage	Vcc*4	Vo + 1.0	16.0	V
Output current	Io	-	1.5	A
Variable output voltage setting value	Vo	1.5	12	V

\*3 When output voltage is 1.5 V, 1.8 V, or 2.5 V.  
 \*4 When output voltage is 3.0 V or higher.

## ●Electrical Characteristics

BA□□JC5T(Unless otherwise specified, Ta = 25°C; Vcc = VCCDC\*5)

Parameter	Symbol	Limits			Unit	Conditions
		Min.	Typ.	Max.		
Output voltage	Vo	Vo (T) × 0.99	Vo (T)	Vo (T) × 1.01	V	Io = 200 mA
Minimum I/O voltage difference*6	ΔVd	-	0.3	0.5	V	Io = 200 mA, Vcc = 0.95 × Vo
Output current capacity	Io	1.5	-	-	A	
Input stability*7	Reg.I	-	5	60	mV	Vcc = Vo + 1.0 V → 16 V, Io = 200 mA
Load stability	Reg.L	-	5	60	mV	Io = 5 mA → 1.5 A
Temperature coefficient of output voltage*8	Tcvo	-	±0.02	-	%/°C	Io = 5 mA, Tj = 0°C to 125°C

Vo (T): Set output voltage

\*5 Vo = 1.5 V, 1.8 V, 2.5 V : Vcc = 3.3 V, Vo = 3.0 V, 3.3 V : Vcc = 5 V,  
Vo = 5.0 V : Vcc = 8 V, Vo = 6.0 V, 6.3 V : Vcc = 9.0 V, Vo = 8.0 V : Vcc = 11 V,  
Vo = 9.0 V : Vcc = 12 V, Vo = 12 V : Vcc = 15 V

\*6 Vo ≥ 3.3 V

\*7 Change Vcc from 3.0 V to 16 V if 1.5 V ≤ Vo ≤ 2.5 V.

\*8 Operation guaranteed

BA00JC5WT (-V5)(Unless otherwise specified, Ta = 25°C, Vcc = 3.3 V, VCTL = 3 V, R1 = 30 kΩ, R2 = 30 kΩ\*9)

Parameter	Symbol	Limits			Unit	Conditions
		Min.	Typ.	Max.		
Reference voltage	Vo	1.2375	1.250	1.2625	V	Io = 50 mA
Shutdown circuit current	I <sub>sd</sub>	-	0	10	μA	V <sub>CTL</sub> = 0 V while in OFF mode
Minimum I/O voltage difference	ΔVd	-	0.3	0.5	V	Io = 500 mA, Vcc = 2.5 V
Output current capacity	Io	1.5	-	-	A	
Input stability	Reg.I	-	5	60	mV	Vcc = 4.5 V → 16 V, Io = 200 mA
Load stability	Reg.L	-	5	60	mV	Io = 5 mA → 1.5 A
Temperature coefficient of output voltage*10	Tcvo	-	±0.02	-	%/°C	Io = 5 mA, Tj = 0°C to 125°C

\*9  $V_{OUT} = V_c \times (R1 + R2) / R1$  (V)

\*10 Design guarantee (No total shipment inspection is made.)

●Electrical Characteristics Curves (Unless otherwise specified, Ta = 25°C; Vcc = 8 V; VCTL = 3 V; Io = 0 mA)

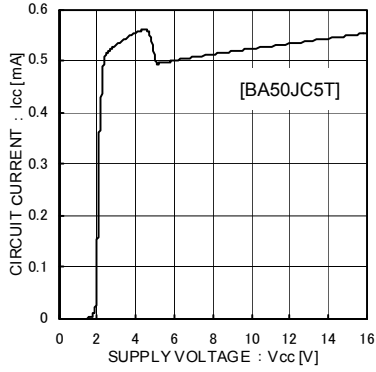

Fig.1 Circuit Current

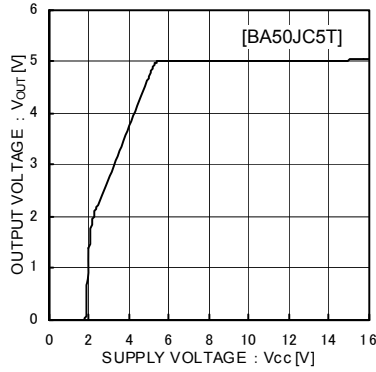

Fig.2 Input Stability(Io=0mA)

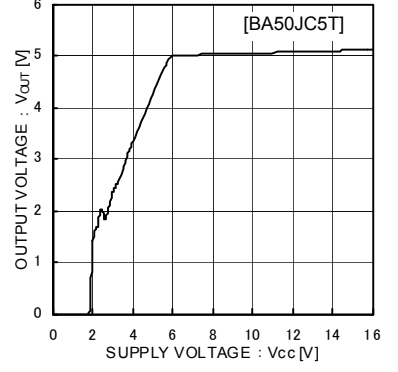

Fig.3 Input Stability (Io = 1.5 A)

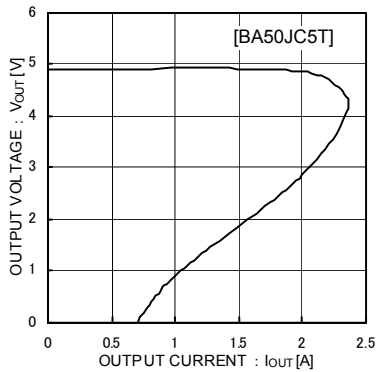

Fig.4 Load Stability

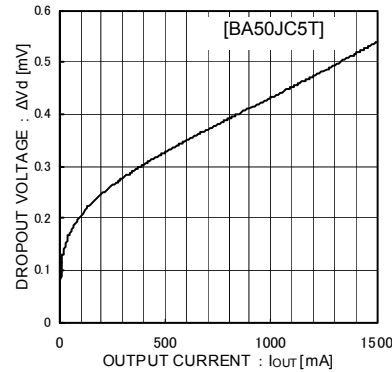

Fig.5 I/O Voltage Difference

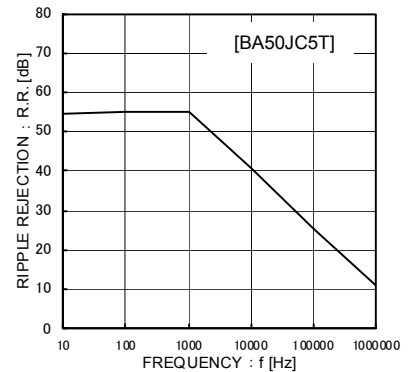

Fig.6 Ripple Rejection

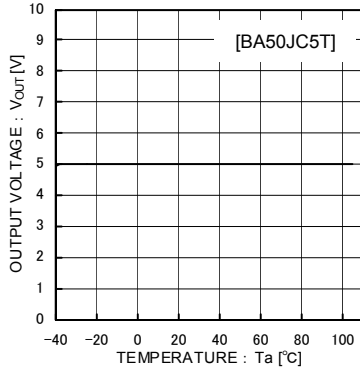

Fig.7 Output Voltage vs Temperature

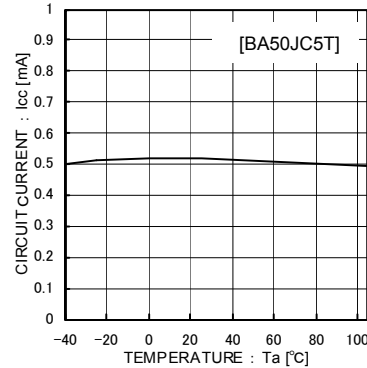

Fig.8 Circuit Current Temperature

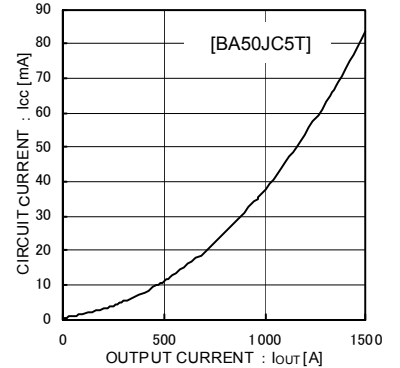

Fig.9 Circuit Current Classified by Load

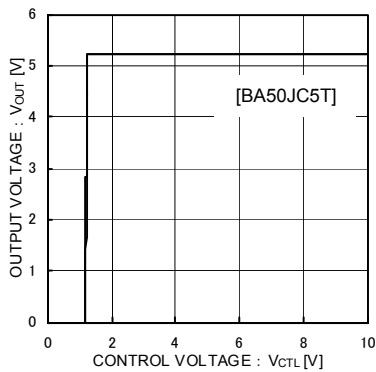

Fig.10 CTL Voltage vs Output Voltage

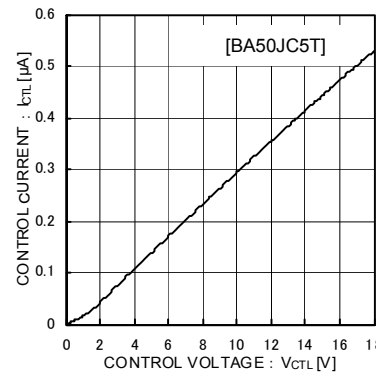

Fig.11 CTL Voltage vs CTL Current

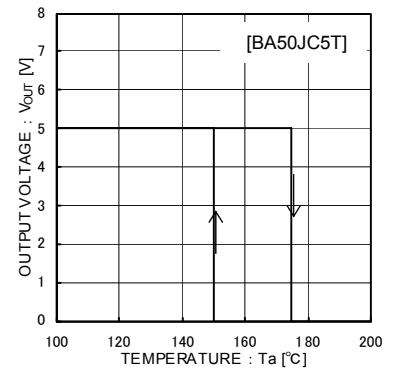
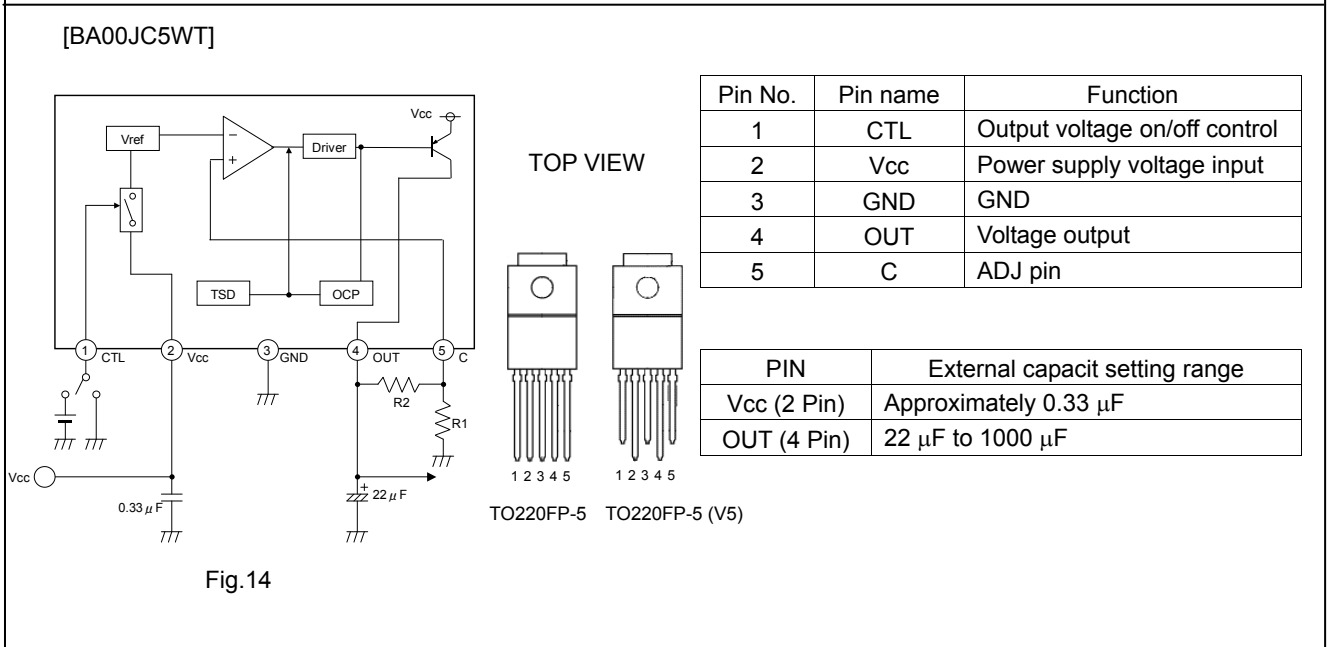
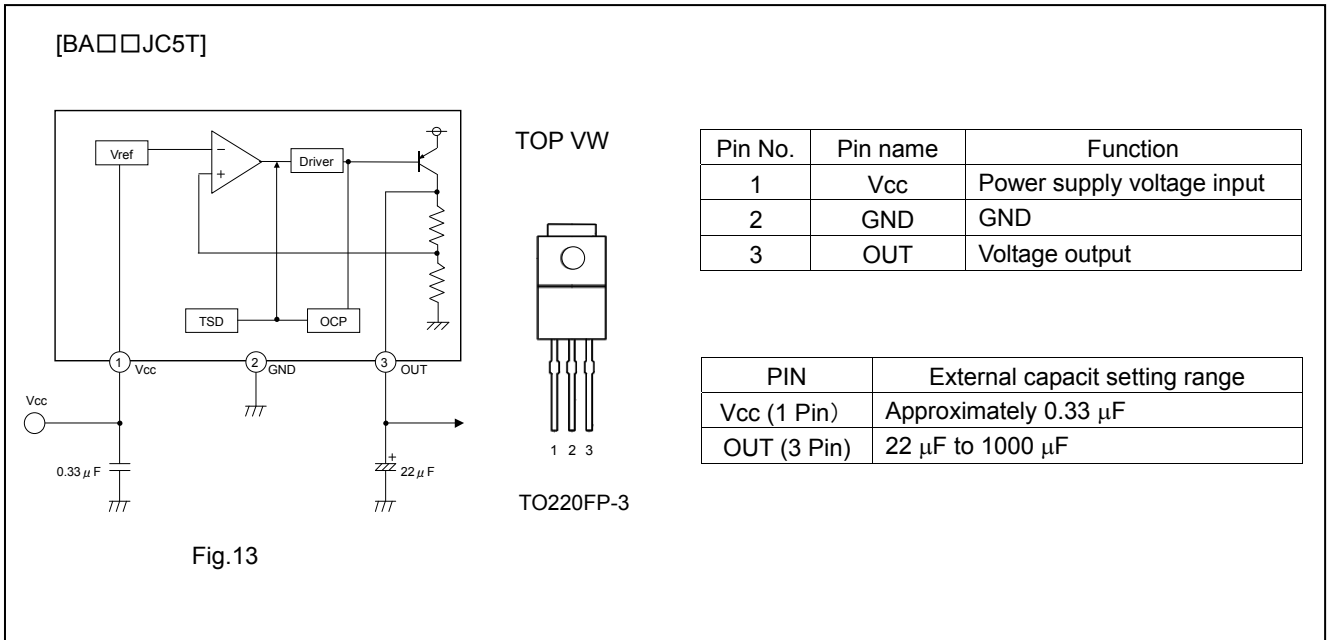
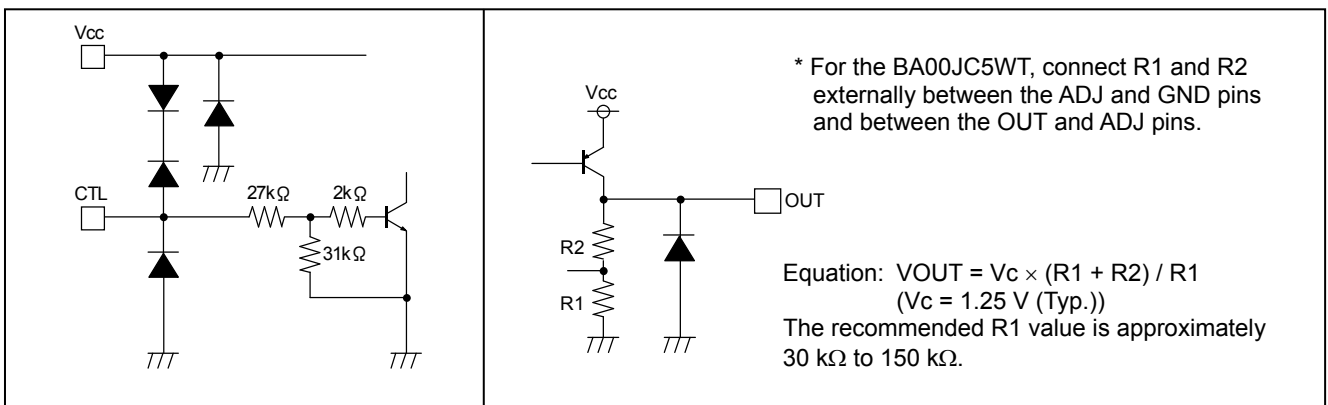

Fig.12 Thermal Shutdown Circuit (Io = 5 mA)

● Block Diagrams / Standard Example Application Circuits



● Input / Output Equivalent Circuits



● Thermal Derating Curve

- TO220FP-3/TO220FP-5/TO220FP-5 (V5)

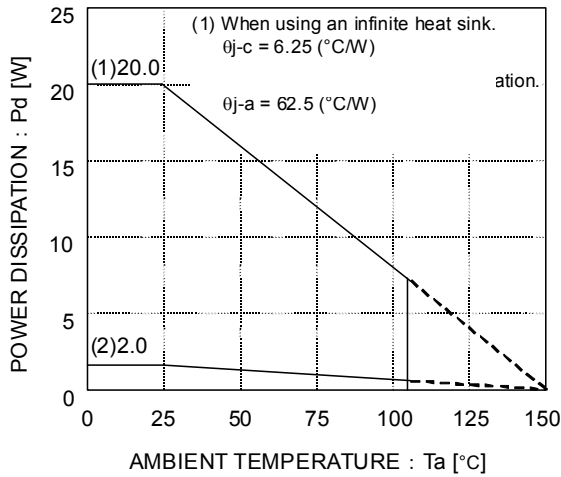

Fig.17

The characteristics of the IC are greatly influenced by the operating temperature. If the temperature exceeds the maximum junction temperature  $T_{jmax}$ , deterioration or damage may occur. Implement proper thermal designs to ensure that power dissipation is within the permissible range in order to prevent instantaneous damage resulting from heat and maintain the reliability of the IC for long-term operation.

The following method is used to calculate the power consumption  $P_c$  (W):

$$P_c = (V_{cc} - V_o) \times I_o + V_{cc} \times I_{cca}$$

$$\text{Power dissipation } P_d \geq P_c$$

- $V_{cc}$  : Input voltage
- $V_o$  : Output current
- $I_o$  : Load current
- $I_{cca}$  : Circuit current

The load current  $I_o$  is calculated:

$$I_o \leq \frac{P_d - V_{cc} \times I_{cca}}{V_{cc} - V_o}$$

Calculation Example:

$V_{cc} = 6.0V$  and  $V_o = 5.0V$  at  $T_a = 85^\circ C$

$$\frac{1.040 - 6.0 \times I_{cca}}{6.0 - 5.0}$$

$$\left[ \begin{array}{l} \theta_{ja} = 62.5^\circ C/W \rightarrow -16.0mW/^\circ C \\ 25^\circ C = 2000mW \rightarrow 85^\circ C = 1040mW \end{array} \right]$$

$$I_o \leq 860mA \quad (I_{cca} \approx 30mA)$$

Refer to the above and implement proper thermal designs so that the IC will not be used under excessive power dissipation conditions under the entire operating temperature range.

The power consumption  $P_c$  of the IC in the event of shorting (i.e. the  $V_o$  and GND pins are shorted) can be obtained from the following equation:  $P_c = V_{cc} \times (I_{cca} + I_{short})$  ( $I_{short}$ : short current)

●Operation Notes

- Vcc pin  
Insert a capacitor (0.33 μF approx.) between VCC and GND.  
The capacitance will vary depending on the application.  
Use a suitable capacitance and implement designs with sufficient margins.
- GND pin  
Verify that there is no potential difference between the ground of the application board and the IC.  
If there is a potential difference, the set voltage will not be output accurately, resulting in unstable IC operation.  
Therefore, lower the impedance by designing the ground pattern as wide and as short as possible.
- CTL pin  
The CTL pin turns on at an operating power supply voltage of 2.0 V or higher and turns off at 0.8 V or lower.  
There is no particular order when turning the power supply and CTL pins on or off.

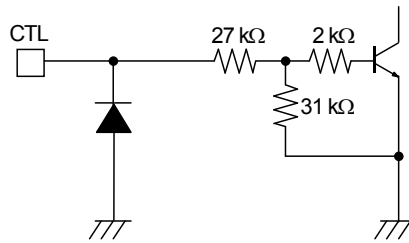

Fig.18 Input Equivalent Circuit

●Vo pin

Insert a capacitor between the Vo and GND pins in order to prevent output oscillation.

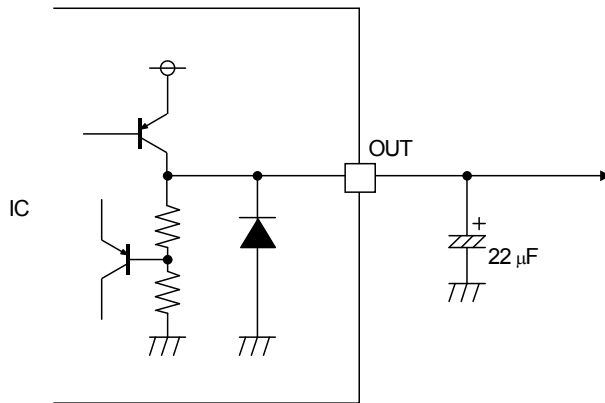

Fig.19 Output Equivalent Circuit

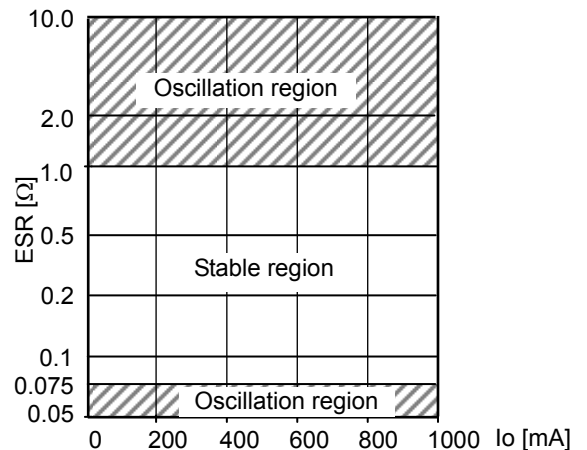

Fig. 20 IO vs ESR

The capacitance may vary greatly with temperature changes, thus making it impossible to completely prevent oscillation. Therefore, use a tantalum aluminum electrolytic capacitor with a low ESR (Equivalent Serial Resistance). The output will oscillate if the ESR is too high or too low, so refer to the ESR characteristics in Fig. 20 and operate the IC within the stable region. Use a capacitor within a capacitance between 22μF and 1,000μF.

●Notes for use

1. Absolute maximum ratings  
An excess in the absolute maximum ratings, such as supply voltage, temperature range of operating conditions, etc., can break down the devices, thus making impossible to identify breaking mode, such as a short circuit or an open circuit. If any over rated values will expect to exceed the absolute maximum ratings, consider adding circuit protection devices, such as fuses.
2. GND voltage  
The potential of GND pin must be minimum potential in all operating conditions.
3. Thermal design  
Use a thermal design that allows for a sufficient margin in light of the power dissipation (Pd) in actual operating conditions.
4. Inter-pin shorts and mounting errors  
Use caution when positioning the IC for mounting on printed circuit boards. The IC may be damaged if there is any connection error or if pins are shorted together.
5. Actions in strong electromagnetic field  
Use caution when using the IC in the presence of a strong electromagnetic field as doing so may cause the IC to malfunction.
6. Testing on application boards  
When testing the IC on an application board, connecting a capacitor to a pin with low impedance subjects the IC to stress. Always discharge capacitors after each process or step. Always turn the IC's power supply off before connecting it to or removing it from a jig or fixture during the inspection process. Ground the IC during assembly steps as an antistatic measure. Use similar precaution when transporting or storing the IC.
7. Regarding input pin of the IC  
This monolithic IC contains P+ isolation and P substrate layers between adjacent elements in order to keep them isolated. P-N junctions are formed at the intersection of these P layers with the N layers of other elements, creating a parasitic diode or transistor. For example, the relation between each potential is as follows:  
When GND > Pin A and GND > Pin B, the P-N junction operates as a parasitic diode.  
When GND > Pin B, the P-N junction operates as a parasitic transistor.  
Parasitic diodes can occur inevitable in the structure of the IC. The operation of parasitic diodes can result in mutual interference among circuits, operational faults, or physical damage. Accordingly, methods by which parasitic diodes operate, such as applying a voltage that is lower than the GND (P substrate) voltage to an input pin, should
8. Ground Wiring Pattern  
When using both small signal and large current GND patterns, it is recommended to isolate the two ground patterns, placing a single ground point at the ground potential of application so that the pattern wiring resistance and voltage variations caused by large currents do not cause variations in the small signal ground voltage. Be careful not to change the GND wiring pattern of any external components, either.
9. Thermal shutdown circuit  
The IC incorporates a built-in thermal shutdown circuit (TSD circuit). The thermal shutdown circuit (TSD circuit) is designed only to shut the IC off to prevent thermal runaway. It is not designed to protect the IC or guarantee its operation. Do not continue to use the IC after operating this circuit or use the IC in an environment where the operation of this circuit is assumed.
10. Overcurrent Protection Circuit  
An overcurrent protection circuit is incorporated in order to prevention destruction due to short-time overload currents. Continued use of the protection circuits should be avoided. Please note that the current increases negatively impact the temperature.
11. Damage to the internal circuit or element may occur when the polarity of the Vcc pin is opposite to that of the other pins in applications. (I.e. Vcc is shorted with the GND pin while an external capacitor is charged.) Use a maximum capacitance of 1000μF for the output pins. Inserting a diode to prevent back-current flow in series with Vcc or bypass diodes between Vcc and each pin is recommended.

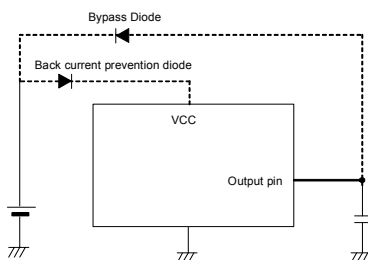

Fig. 21 Bypass Diode

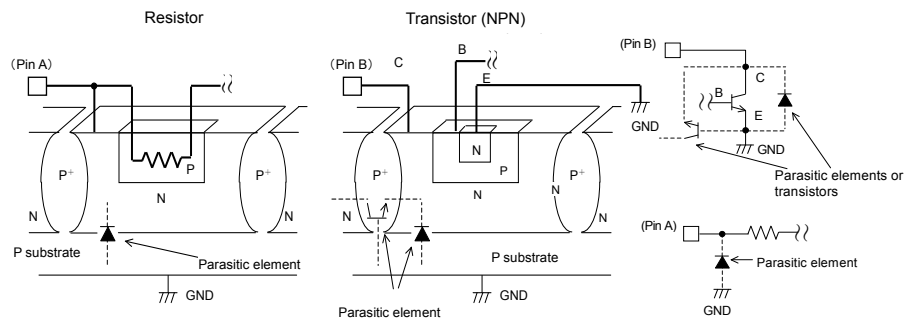
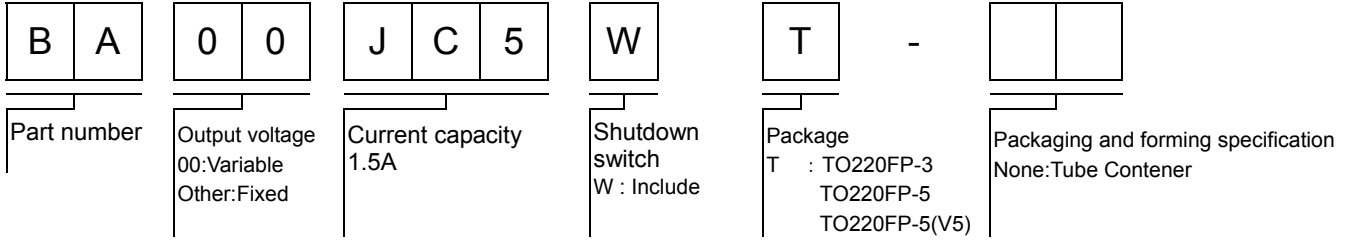

Fig. 22 Example of Simple Bipolar IC Architecture



●Ordering part number



TO220FP-3

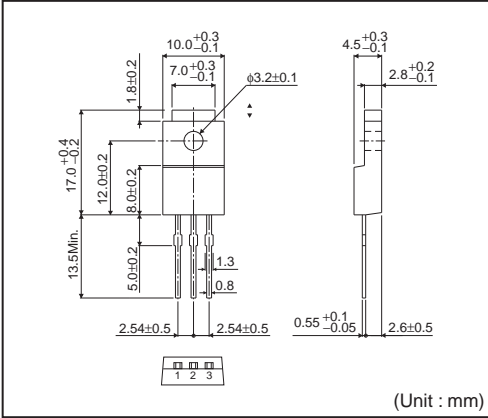

<Tape and Reel information>

Container	Tube
Quantity	500pcs
Direction of feed	Direction of products is fixed in a container tube

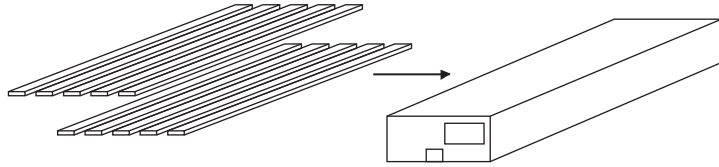

\*Order quantity needs to be multiple of the minimum quantity.

TO220FP-5

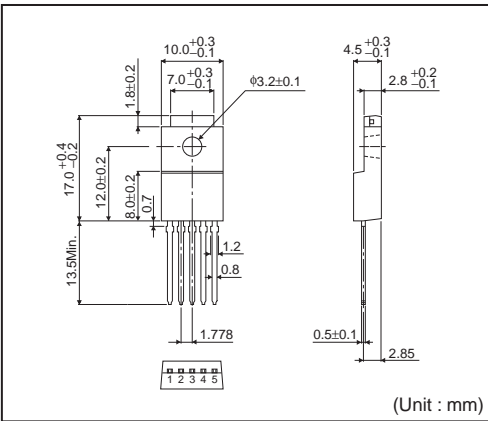

<Tape and Reel information>

Container	Tube
Quantity	500pcs
Direction of feed	Direction of products is fixed in a container tube

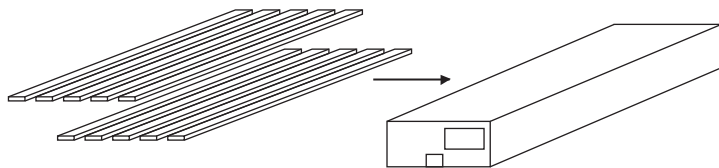

\*Order quantity needs to be multiple of the minimum quantity.

TO220FP-5(V5)

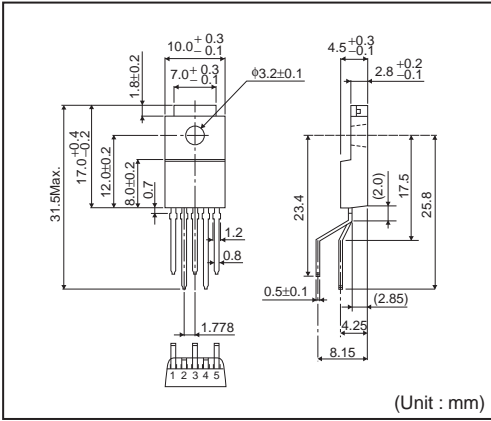

<Tape and Reel information>

Container	Tube
Quantity	500pcs
Direction of feed	Direction of products is fixed in a container tube

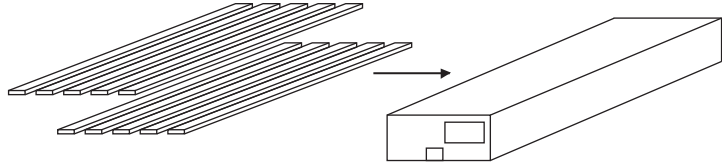

\* Order quantity needs to be multiple of the minimum quantity.

## Notes

No copying or reproduction of this document, in part or in whole, is permitted without the consent of ROHM Co.,Ltd.

The content specified herein is subject to change for improvement without notice.

The content specified herein is for the purpose of introducing ROHM's products (hereinafter "Products"). If you wish to use any such Product, please be sure to refer to the specifications, which can be obtained from ROHM upon request.

Examples of application circuits, circuit constants and any other information contained herein illustrate the standard usage and operations of the Products. The peripheral conditions must be taken into account when designing circuits for mass production.

Great care was taken in ensuring the accuracy of the information specified in this document. However, should you incur any damage arising from any inaccuracy or misprint of such information, ROHM shall bear no responsibility for such damage.

The technical information specified herein is intended only to show the typical functions of and examples of application circuits for the Products. ROHM does not grant you, explicitly or implicitly, any license to use or exercise intellectual property or other rights held by ROHM and other parties. ROHM shall bear no responsibility whatsoever for any dispute arising from the use of such technical information.

The Products specified in this document are intended to be used with general-use electronic equipment or devices (such as audio visual equipment, office-automation equipment, communication devices, electronic appliances and amusement devices).

The Products specified in this document are not designed to be radiation tolerant.

While ROHM always makes efforts to enhance the quality and reliability of its Products, a Product may fail or malfunction for a variety of reasons.

Please be sure to implement in your equipment using the Products safety measures to guard against the possibility of physical injury, fire or any other damage caused in the event of the failure of any Product, such as derating, redundancy, fire control and fail-safe designs. ROHM shall bear no responsibility whatsoever for your use of any Product outside of the prescribed scope or not in accordance with the instruction manual.

The Products are not designed or manufactured to be used with any equipment, device or system which requires an extremely high level of reliability the failure or malfunction of which may result in a direct threat to human life or create a risk of human injury (such as a medical instrument, transportation equipment, aerospace machinery, nuclear-reactor controller, fuel-controller or other safety device). ROHM shall bear no responsibility in any way for use of any of the Products for the above special purposes. If a Product is intended to be used for any such special purpose, please contact a ROHM sales representative before purchasing.

If you intend to export or ship overseas any Product or technology specified herein that may be controlled under the Foreign Exchange and the Foreign Trade Law, you will be required to obtain a license or permit under the Law.



Thank you for your accessing to ROHM product informations.  
More detail product informations and catalogs are available, please contact us.

### ROHM Customer Support System

<http://www.rohm.com/contact/>