



MMBT1815

NPN SILICON TRANSISTOR

HIGH FREQUENCY NPN AMPLIFIER TRANSISTOR

FEATURES

- *Collector-Emitter Voltage:
BV_{CEO}=50V
- *Collector current up to 150mA
- *High h_{FE} linearity
- *Complement to MMBT1015

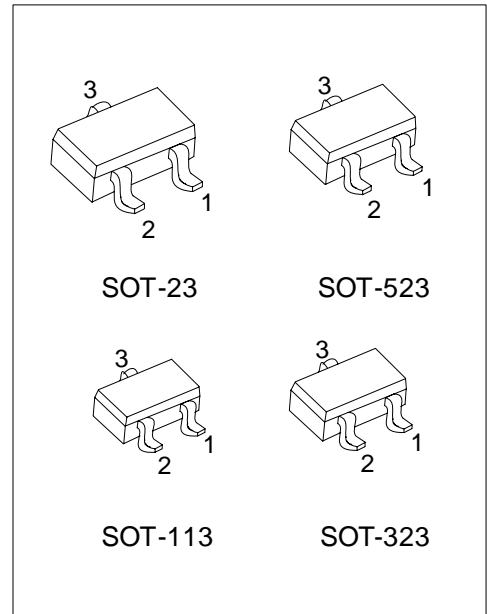

*Pb-free plating product number: MMBT1815L

ORDERING INFORMATION

Order Number		Package	Pin Assignment			Packing
Normal	Lead Free Plating		1	2	3	
MMBT1815-x-AC3-R	MMBT1815L-x-AC3-R	SOT-113	E	B	C	Tape Reel
MMBT1815-x-AE3-R	MMBT1815L-x-AE3-R	SOT-23	E	B	C	Tape Reel
MMBT1815-x-AL3-R	MMBT1815L-x-AL3-R	SOT-323	E	B	C	Tape Reel
MMBT1815-x-AN3-R	MMBT1815L-x-AN3-R	SOT-523	E	B	C	Tape Reel

<p>MMBT1815L-x-AC3-R</p>	<p>(1) R: Tape Reel (2) AC3: SOT-113, AE3: SOT-23, AL3: SOT-323, AN3: SOT-523 (3) x: refer to Classification of h_{FE1} (4) L: Lead Free Plating, Blank: Pb/Sn</p>
--------------------------	---

MARKING

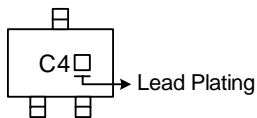

MMBT1815

NPN SILICON TRANSISTOR

■ ABSOLUTE MAXIMUM RATING (Ta=25°C, unless otherwise specified)

PARAMETER	SYMBOL	RATINGS	UNIT
Collector-Base Voltage	V _{CBO}	60	V
Collector-Emitter Voltage	V _{CEO}	50	V
Emitter-Base Voltage	V _{EBO}	5	V
Collector Dissipation (Ta=25°C)	SOT-23	250	mW
	SOT-523/SOT-113/SOT-323	200	mW
Collector Current	I _C	150	mA
Base Current	I _B	50	mA
Junction Temperature	T _J	150	
Storage Temperature	T _{STG}	-55 ~ +150	

Note Absolute maximum ratings are those values beyond which the device could be permanently damaged. Absolute maximum ratings are stress ratings only and functional device operation is not implied.

■ ELECTRICAL CHARACTERISTICS (Ta=25°C, unless otherwise specified)

PARAMETER	SYMBOL	TEST CONDITIONS	MIN	TYP	MAX	UNIT
Collector-Emitter Saturation Voltage	V _{CE(SAT)}	I _C = 100mA, I _B = 10mA		0.1	0.25	V
Base-Emitter Saturation Voltage	V _{BE(SAT)}	I _C = 100mA, I _B = 10mA			1.0	V
Collector Cut-off Current	I _{CBO}	V _{CB} = 60V, I _E = 0			100	nA
Emitter Cut-off Current	I _{EBO}	V _{EB} = 5V, I _C = 0			100	nA
DC Current Gain	h _{FE1}	V _{CE} = 6V, I _C = 2mA	120		700	
	h _{FE2}	V _{CE} = 6V, I _C = 150mA	25			
Transition Frequency	f _T	V _{CE} = 10V, I _C = 50mA	80			MHz
Output Capacitance	C _{OB}	V _{CB} = 10V, I _E = 0, f = 1MHz		2.0	3.0	pF
Noise Figure	NF	I _C = -0.1mA, V _{CE} = 6V R _G = 10kΩ, f = 100Hz		1.0	1.0	dB

■ CLASSIFICATION OF h_{FE1}

RANK	Y	GR	BL
RANGE	120-240	200-400	350-700

TYPICAL CHARACTERISTICS

Static Characteristics

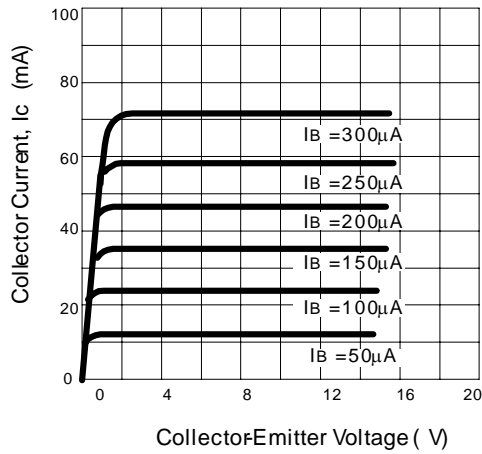

DC Current Gain

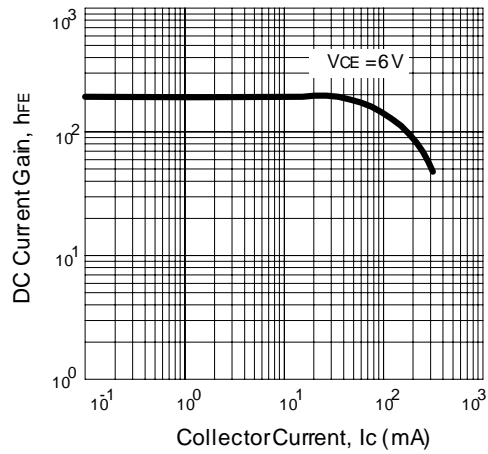

Base-Emitter On Voltage

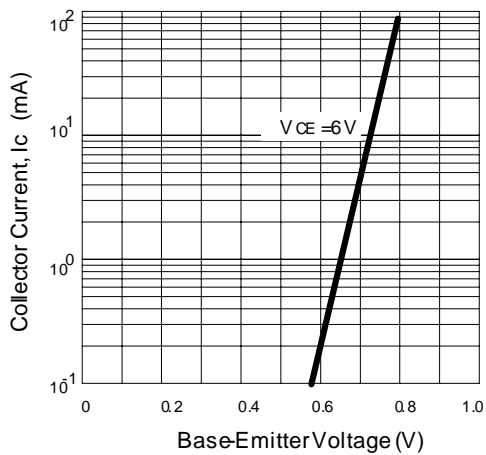

Saturation Voltage

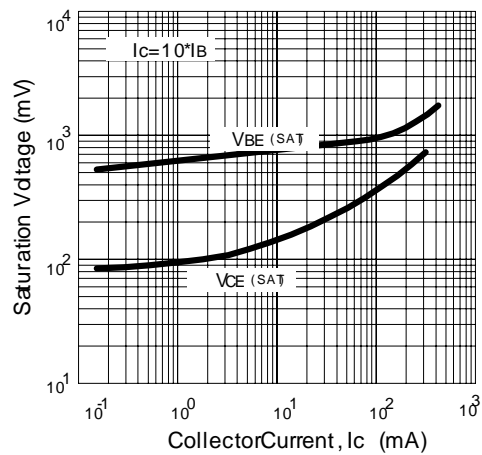

Current Gain-Bandwidth Product

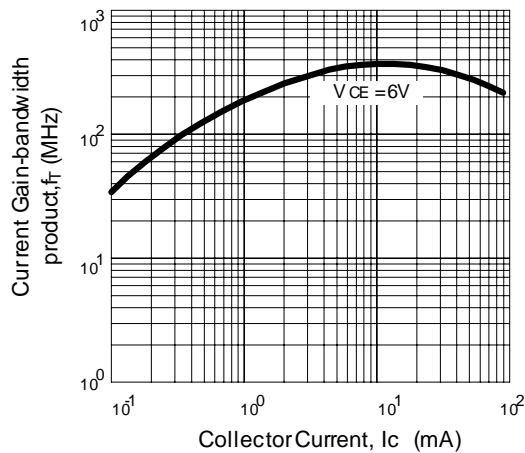

Collector Output Capacitance

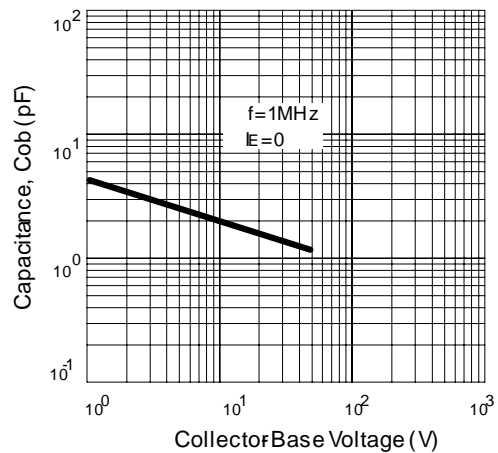

UTC assumes no responsibility for equipment failures that result from using products at values that exceed, even momentarily, rated values (such as maximum ratings, operating condition ranges, or other parameters) listed in products specifications of any and all UTC products described or contained herein. UTC products are not designed for use in life support appliances, devices or systems where malfunction of these products can be reasonably expected to result in personal injury. Reproduction in whole or in part is prohibited without the prior written consent of the copyright owner. The information presented in this document does not form part of any quotation or contract, is believed to be accurate and reliable and may be changed without notice.