

Piezo Buzzer (DC)

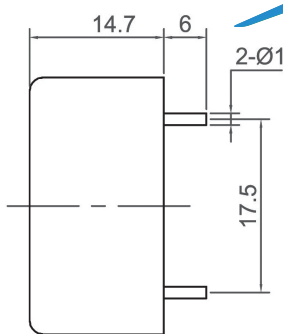

CPB3015

Canopus Part no.	Operating Voltage (VDC)	Rated Voltage (VDC)	Max Rated Current (mA)	Min Sound Output (dBA)	Resonant Frequency (Hz)	Tone Nature	Operating Temperature (°C)	Housing	Weight (g)
CPB3015EC30BP	3 ~ 12	5	6	80 at 30cm	3000 ± 500	Continuous	-20 ~ +60	ABS	3
CPB3015HC30BP	3 ~ 20	12	10	90 at 30cm	3000 ± 500	Continuous	-20 ~ +60	ABS	3

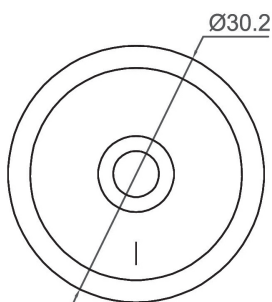

CPB3017

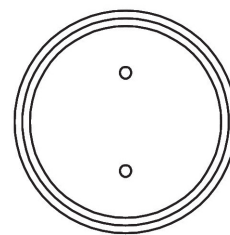
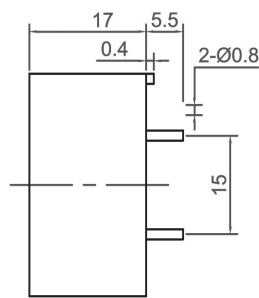
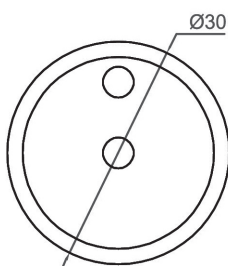

Canopus Part no.	Operating Voltage (VDC)	Rated Voltage (VDC)	Max Rated Current (mA)	Min Sound Output (dBA)	Resonant Frequency (Hz)	Tone Nature	Operating Temperature (°C)	Housing	Weight (g)
CPB3017HC18BP	3 ~ 30	12	12	87 at 10cm	1800 ± 500	Continuous	-20 ~ +60	ABS	5

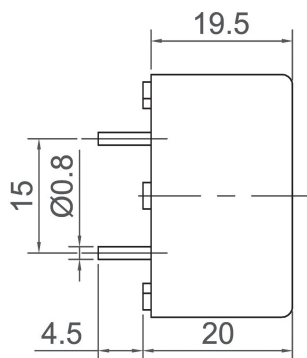
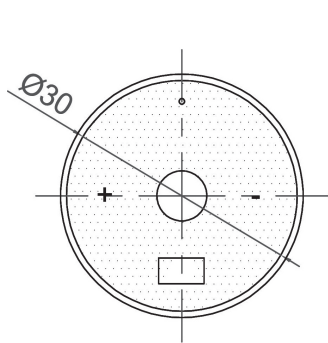

CPB3019

Canopus Part no.	Operating Voltage (VDC)	Rated Voltage (VDC)	Max Rated Current (mA)	Min Sound Output (dBA)	Resonant Frequency (Hz)	Tone Nature	Operating Temperature (°C)	Housing	Weight (g)
CPB3019CC35TP	2 ~ 5	3	10	90 at 30cm	3500 ± 500	Continuous	-20 ~ +60	PBT	10
CPB3019HC35TP	3 ~ 20	12	10	90 at 30cm	3500 ± 500	Continuous	-20 ~ +60	PBT	10

CANOPUS

Your Efficient Supplier
www.canopus.com.hk

TEL.: (852) 2806 2812

Fax: (852) 2652 2216