

JVC

SERVICE MANUAL

COLOUR TELEVISION

AV28BT5ENS / AV28BT5ENB
AV28BT5EES / AV28BT5EEB

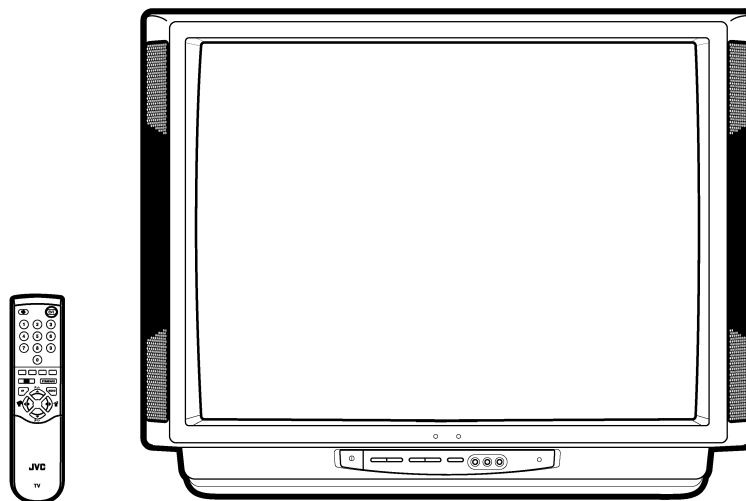

CONTENTS

■ SPECIFICATIONS	2
■ SAFETY PRECAUTIONS	4
■ FEATURES	5
■ MAIN DIFFERENCE PARTS LIST	5
■ SPECIFIC SERVICE INSTRUCTIONS	6
■ SERVICE ADJUSTMENTS	9
■ PARTS LIST	17
★ OPERATING INSTRUCTIONS	
★ STANDARD CIRCUIT DIAGRAM	2-1

SPECIFICATIONS

ITEM	Content	
	AV28BT5ENS (Silver) AV28BT5ENB (Black)	AV28BT5EES (Silver) AV28BT5EEB (Black)
Dimensions (WxHxD)	69 x 54 x 47 cm	
Weight	34.6 kg	
TV RF System	B/G	B/G, D/K, K1
Colour System	TV Mode	PAL
	Video Mode	PAL / NTSC 3.58 / NTSC 4.43
Teletext System	Fastext / Toptext	
Stereo System	A2 / German + NICAM	
Tuning System	Frequency Synthesizer Tuning System	
Number Of CH memory position	100 ch	
Receiving Frequency	VHF (VL)	46.25MHz ~ 168.25MHz
	VHF (VH)	175.25MHz ~ 463.25MHz
	UHF	471.25MHz ~ 863.25MHz
	CATV	Super (S11-S20) & Hyper (S21-S41) bands receivable
Intermediate Frequency	VIF Carrier	38.9MHz
	SIF Carrier	32.4MHz (6.5MHz)
		32.9MHz (6.0MHz)
		33.4MHz (5.5MHz)
Colour Sub Carrier Frequency	PAL (4.43MHz), SECAM (4.43MHz), NTSC (3.58MHz/4.43MHz)	
Aerial Input Terminal	75Ohm Unbalanced	
Power Input	AC 170 ~ 270V	
Power Consumption	126W(Max.)/103W(Avg.) Stand-by<5W	
Picture Tube	28 inch measured diagonally	
High Voltage	28kV (in cut-off service mode)	
Speaker	101 mm round type X 2	
Audio Output	8W + 8W	
Input	Video	1Vp-p, 75 Ohm
	S/Video	Y: 1Vp-p Positive C: 0.286Vp-p
	Audio (L/R)	500 mVrms, High Impedance
Output	Video	1 Vp-p, 75 Ohm
	Audio (L/R)	500 mVrms, Low Impedance
Input Terminal	Rear Side	AV1 (Video/Audio/RGB)
		AV2 (Video/Audio/S-VHS)
	Front Side	AV3 (Video/Audio)
Output Terminal	Front Side	Headphone jack (Stereo mini jack 3.5Ø)
	Rear Side	AV1 (Video/Audio)
		AV2 (Video/Audio) (Selected TV, AV1 or AV3)
Remote Control Unit	RM-C85, Battery size:AAA/R03 x 2	

Design & specifications are subject to change without notice.

■ 21-pin Euro connector (SCART socket) : AV-1 / AV-2

(P-P= Peak to Peak, S-W= Sync tip to white peak, B-W= Blanking to white peak)

Pin No.	Signal Designation	Matching Value	AV-1	AV-2
1	AUDIO R output	500mVrms(Nominal),Low impedance	○ (TV OUT)	○ (TV/LINE OUT)
2	AUDIO R input	500mVrms(Nominal),High impedance	○	○
3	AUDIO L output	500mVrms(Nominal),Low impedance	○ (TV OUT)	○ (TV/LINE OUT)
4	AUDIO GND		○	○
5	GND (B)		○	○
6	AUDIO L input	500mVrms(Nominal), High impedance	○	○
7	B input	700mVB-w, 75Ω	○	NC
8	FUNCTON SW (SLOW SW)	Low : 0-3V, High : 8-12V, High impedance	○	NC
9	GND (G)		○	○
10	-		NC	-
11	G input	700mVB-w, 75Ω	○	NC
12	-		NC	-
13	GND (R)		○	○
14	GND (YS)		○	NC
15	R / C input	R : 700mVB-w, 75Ω C : 300mVP-P, 75Ω	○ (R/C)	○ (only C)
16	Ys input	Low : 0 – 0.4, High : 1 - 3V, 75Ω	○	NC
17	GND(VIDEO output)		○	○
18	GND(VIDEO input)		○	○
19	VIDEO output	1Vs-w(Negative going sync), 75Ω	○ (TV)	○ (TV/LINE OUT)
20	VIDEO / Y input	1Vs-w(Negative going sync), 75Ω	○	○
21	COMMON GND		○	○

[Pin assignment]

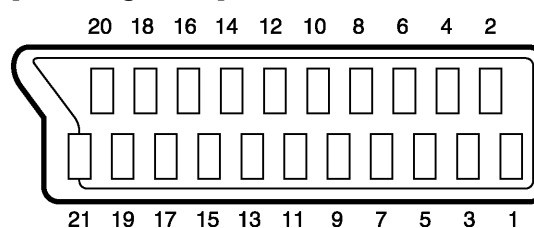

SAFETY PRECAUTIONS

1. The design of this product contains special hardware in many circuits and components specially for safety purposes. For continued protection, no changes should be made to the original design unless authorized in writing by the manufacturer. Replacement parts must be identical to those used in the original circuits. Service should be performed by qualified personnel only.
2. Alterations of the design or circuitry of the product should not be made. Any design alterations or additions will void the manufacturer's warranty and will further relieve the manufacturer of responsibility for personal injury or property damage resulting therefrom.
3. Many electrical and mechanical parts in the products have special safety-related characteristics. These characteristics are often not evident from visual inspection nor can the protection afforded by them necessary be obtained by using replacement components rated for higher voltage, wattage, etc. Replacement parts which have these special safety characteristics are identified in the Parts List of Service Manual. **Electrical components having such features are identified by shading on the schematics and by (Δ) on the Parts List in the Service Manual.** The use of a substitute replacement which does not have the same safety characteristics as the recommended replacement part shown in the Parts List of Service Manual may cause shock, fire, or other hazards.
4. **Don't short between the LIVE side ground and ISOLATED (NEUTRAL) side ground or EARTH side ground when repairing.**
Some models power circuit is partly different in the GND. The difference of the GND is shown by the LIVE : (⊥) side GND, the ISOLATED(NEUTRAL) : (⊕) side GND and EARTH : (⊕) side GND. Don't short between the LIVE side GND and ISOLATED (NEUTRAL) side GND or EARTH side GND and never measure with a measuring apparatus (oscilloscope etc.) the LIVE side GND and ISOLATED(NEUTRAL) side GND or EARTH side GND at the same time.
If above note will not be kept, a fuse or any parts will be broken.
5. If any repair has been made to the chassis, it is recommended that the B1 setting should be checked or adjusted (See ADJUSTMENT OF B1 POWER SUPPLY).
6. The high voltage applied to the picture tube must conform with that specified in Service manual. Excessive high voltage can cause an increase in X-Ray emission, arcing and possible component damage, therefore operation under excessive high voltage conditions should be kept to minimum, or should be prevented. If severe arcing occurs, remove the AC power immediately and determine the cause by visual inspection (incorrect installation, cracked or melted high voltage harness, poor soldering, etc.). To maintain the proper minimum level of soft X-Ray emission, components in the high voltage circuitry including the picture tube must be the exact replacements or alternatives approved by the manufacturer of the complete product.
7. Do not check high voltage by drawing an arc. Use a high voltage meter or a high voltage probe with a VTVM. Discharge the picture tube before attempting meter connection, by connecting a clip lead to the ground frame and connecting the other end of the lead through a 10kΩ 2W resistor to the anode button.

8. When service is required, observe the original lead dress. Extra precaution should be given to assure correct lead dress in the high voltage circuit area. Where a short circuit has occurred, those components that indicate evidence of overheating should be replaced. Always use the manufacturer's replacement components.

9. **Isolation Check
(Safety for Electrical Shock Hazard)**

After re-assembling the product, always perform an isolation check on the exposed metal parts of the cabinet (antenna terminals, video/audio input and output terminals, Control knobs, metal cabinet, screwheads, earphone jack, control shafts, etc.) to be sure the product is safe to operate without danger of electrical shock.

(1) **Dielectric Strength Test**

The isolation between the AC primary circuit and all metal parts exposed to the user, particularly any exposed metal part having a return path to the chassis should withstand a voltage of 3000V AC(r.m.s.) for a period of one second.

(. . .Withstand a voltage of 1100V AC (r.m.s.) to an appliance rated up to 120V, and 3000V AC (r.m.s.) to an appliance rated 200V or more, for a period of one second.)

This method of test requires a test equipment not generally found in the service trade.

(2) **Leakage Current Check**

Plug the AC line cord directly into the AC outlet (do not use a line isolation transformer during this check.). Using a "Leakage Current Tester", measure the leakage current from each exposed metal part of the cabinet, particularly any exposed metal part having a return path to the chassis, to a known good earth ground (water pipe, etc.). Any leakage current must not exceed 0.5mA AC(r.m.s.).

● **Alternate Check Method**

Plug the AC line cord directly into the AC outlet (do not use a line isolation transformer during this check.). Use an AC voltmeter having 1000 ohms per volt or more sensitivity in the following manner. Connect a 1500Ω 10W resistor paralleled by a 0.15μF AC-type capacitor between an exposed metal part and a known good earth ground (water pipe, etc.). Measure the AC voltage across the resistor with the AC voltmeter. Move the resistor connection to each exposed metal part, particularly any exposed metal part having a return path to the chassis, and measure the AC voltage across the resistor. Now, reverse the plug in the AC outlet and repeat each measurement. Any voltage measured must not exceed 0.35V AC (r.m.s.). This corresponds to 0.5mA AC (r.m.s.).

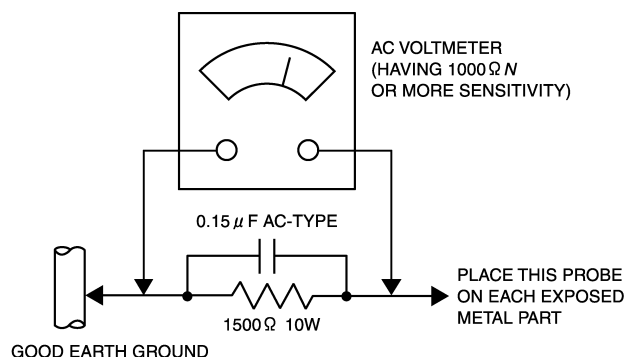

FEATURES

1. It is a remote controlled color television.
2. 100 programs from VHF, UHF bands or cable channels can be preset.
3. It can tune cable channels.
4. Controlling the TV is very easy by its menu driven system.
5. It has two Euroconnector sockets for external device (such as video recorder, video games, audio set, etc.)
6. Front AV Input available.
7. Stereo sound systems (German + Nicam) are available.
8. Full function Teletext (Fastext, Toptext).
9. It is possible to connect headphone.
10. Direct channel access.
11. APS (Automatic Programming System).
12. All programs can be named.
13. Forward or backward automatic tuning.
14. Automatic sound mute when no transmission.
15. 5 minutes after the broadcasting (closedown), the TV switches itself automatically to stand-by mode.

MAIN DIFFERENCE LIST

MODEL No. Parts Name	AV28BT5ENS (Silver)	AV28BT5ENB (Black)	AV28BT5EES (Silver)	AV28BT5EEB (Black)
MAIN PWB	VE-20073586	←	VE-20073447	←
F CARTON BOX	VE-20074229	VE-20073917	VE-20074101	VE-20074115
INST BOOK	VE-50021021	←	VE-50021020	←
RATING LABEL	VE-20074227	VE-20073915	VE-20074100	VE-20074113
FRONT CABINET	VE-20073707	VE-20003525	VE-20073707	VE-20003525
BACK COVER	VE-20004635	VE-20016402	VE-20004635	VE-20016402

SPECIFIC SERVICE INSTRUCTIONS

DISASSEMBLY PROCEDURE

REMOVING THE REAR COVER

1. Remove the 8 screws marked **A**.
2. Withdraw the rear cover toward you.

REMOVING THE HEADPHONE JACK BOARD ASS'Y

- After removing the rear cover.
1. Remove the 1 screw marked **B**.
 2. After pulling JACK BOARD back, it shifts rightward.

REMOVING THE SPEAKER

- After removing the rear cover.
1. Remove the 2 screws marked **C**, and remove the SPEAKER BKT ASS'Y.
 2. Remove the 4 screws marked **D**, and remove the SPEAKER BKT COVER.
 3. Remove the 4 screws marked **E**, and remove the SPEAKER.

REMOVING THE MAIN PWB & PROCEDURE TO DEVELOPMENT

- After removing the rear cover.
1. Remove the JACK BOARD ASS'Y.
 2. Remove the LEFT SPEAKER BKT ASS'Y.
 3. Remove the POWER SUPPLY TRANSFORMER.
 4. Remove the 2 screws marked **F** attached to the MAIN PWB ASS'Y.

CAUTIONS)

Be careful enough when developing a main chassis. The wire of a POWER TRANSFER does not separate and short-circuit with other parts.

REMOVING THE FRONT CONTROL PWB

- After removing the rear cover.
1. Remove the MAIN PWB ASS'Y.
 2. Remove the 6 screws marked **G**, and remove the FRONT CONTROL PWB.

REMOVING THE POWER SW

- After removing the rear cover.
1. Remove the MAIN PWB ASS'Y.
 2. Remove the 2 screws marked **H**, and remove the POWER SW.

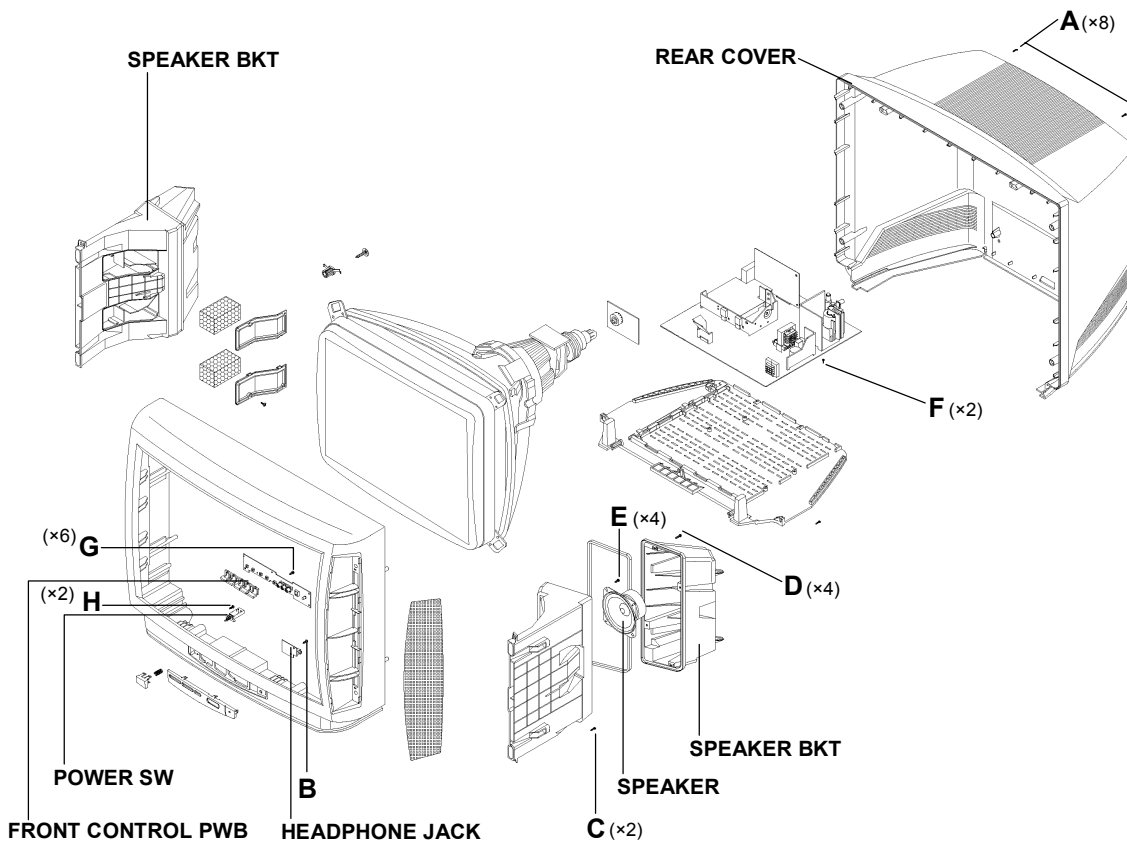

SETTING OF THE LAST MEMORY FOR SHIPMENT

■ USER SETTING VALUES

Setting Item	Setting Value	Setting Item	Setting Value
SOUND MENU		FEATURE MENU	
BASS	CENTER	SLEEP TIMER	OFF
TREBLE	↑	CHILD LOCK	OFF
BALANCE	↑		
EFFECT	OFF		
PICTURE MENU		INSTALL-> TV CONFIG. MENU	
BRIGHTNESS	These adjust are automatically restored when APS bit in Service menu is set. The procedure for selling APS bit is discribed below.	LANGUAGE	ENGLISH
COLOUR		COUNTRY	?
CONTRAST		AV-2 OUTPUT	TV
SHARPNESS			
HUE (only NTSC)			
PICTURE MODE	AUTO		

■ SETTING APS BIT IN SERVICE MENU

- 1) Enter service menu in TV mode by pressing "INFO" and "MUTING" keys simultaneously. Service Menu will appear.
- 2) Select OPTIONS by pressing Up/Down keys on remote control unit.
- 3) Enter OPTIONS by pressing Left/Right keys on remote control unit.
- 4) Select OPTION 8 by pressing Up/Down keys on remote control unit.
- 5) Selected bit in one OPTION is shown by blinking character. Select B2 by pressing Left/Right keys on remote control unit.
DO NOT CHANGE ANY OTHER BIT.
- 6) Press digit key "1" to set APS bit.
- 7) Press "STANDARD" key on remote control unit to exit service mode.

REPLACEMENT OF CHIP COMPONENT

■ CAUTIONS

1. Avoid heating for more than 3 seconds.
2. Do not rub the electrodes and the resist parts of the pattern.
3. When removing a chip part, melt the solder adequately.
4. Do not reuse a chip part after removing it.

■ SOLDERING IRON

1. Use a high insulation soldering iron with a thin pointed end of it.
2. A 30w soldering iron is recommended for easily removing parts.

■ REPLACEMENT STEPS

1. How to remove Chip parts

◆ Resistors, capacitors, etc.

- (1) As shown in the figure, push the part with tweezers and alternately melt the solder at each end.

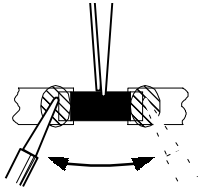

- (2) Shift with tweezers and remove the chip part.

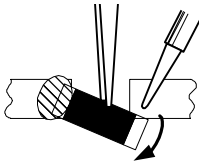

◆ Transistors, diodes, variable resistors, etc.

- (1) Apply extra solder to each lead.

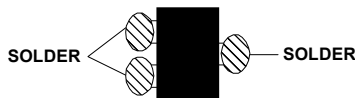

- (2) As shown in the figure, push the part with tweezers and alternately melt the solder at each lead. Shift and remove the chip part.

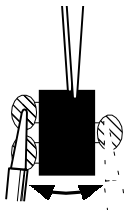

Note : After removing the part, remove remaining solder from the pattern.

2. How to install Chip parts

◆ Resistors, capacitors, etc.

- (1) Apply solder to the pattern as indicated in the figure.

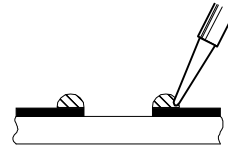

- (2) Grasp the chip part with tweezers and place it on the solder. Then heat and melt the solder at both ends of the chip part.

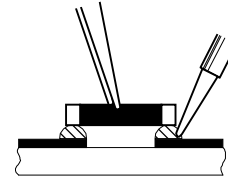

◆ Transistors, diodes, variable resistors, etc.

- (1) Apply solder to the pattern as indicated in the figure.
- (2) Grasp the chip part with tweezers and place it on the solder.
- (3) First solder lead **A** as indicated in the figure.

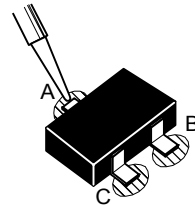

- (4) Then solder leads **B** and **C**.

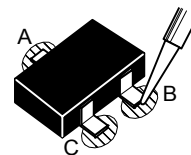

BASIC OPERATION SERVICE MENU

■ HOW TO ENTER THE SERVICE MODE

- 1) Press the **INFORMATION** key and **MUTING** key of REMOTE CONTROL UNIT, simultaneously.

■ SELECTION OF ADJUSTMENT ITEMS

- 1) Press the **UP** (▲) or **DOWN** (▼) key and select the ADJUSTMENT ITEM.
- 2) Press the **RIGHT** (▶) or **LEFT** (◀) key and enter ADJUSTMENT SCREEN.
- 3) To change the selected Parameter, use **RIGHT** (▶) and **LEFT** (◀) key.

■ HOW TO EXIT SERVICE MODE

- 1) Press the **STANDARD** Key on REMOTE CONTROL UNIT.

■ ADJUSTMENT SERVICE MENU

ADJUSTMENT ITEM	ADJUST No.	DISCRIPTION
WHITE BALANCE	00	White Point RED
	01	White Point GREEN
	02	White Point BLUE
AGC	03	AGC
IF-PLL NEGATIVE	04	IF-PLL Negative
IF-PLL POSITIVE	05	IF-PLL Positive
LUMINANCE DELAY	06	Y-Delay PAL
	07	Y-Delay SECAM
	08	Y-Delay NTSC
VERTICAL ZOOM	10	4 : 3 PICTURE MODE
	21	16 : 9 PICTURE MODE
VERTICAL SCROLL	11	4 : 3 PICTURE MODE
	22	16 : 9 PICTURE MODE
4 : 3 HORIZONTAL SHIFT	12	4 : 3 PICTURE MODE
	23	16 : 9 PICTURE MODE
VERTICAL SLOPE	13	4 : 3 PICTURE MODE
	24	16 : 9 PICTURE MODE
VERTICAL AMPLITUD	14	4 : 3 PICTURE MODE
	25	16 : 9 PICTURE MODE
S-CORRECTION	15	4 : 3 PICTURE MODE
	26	16 : 9 PICTURE MODE
VERTICAL SHIFT	16	4 : 3 PICTURE MODE
	27	16 : 9 PICTURE MODE
EW WIDTH	17	4 : 3 PICTURE MODE
	28	16 : 9 PICTURE MODE
EW PARABOLA WIDTH	18	4 : 3 PICTURE MODE
	29	16 : 9 PICTURE MODE
EW CORNER PARABOLA	19	4 : 3 PICTURE MODE
	30	16 : 9 PICTURE MODE
EW TRAPEZIUM	20	4 : 3 PICTURE MODE
	31	16 : 9 PICTURE MODE

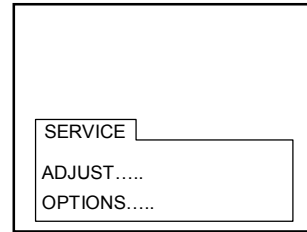

SERVICE MENU SCREEN

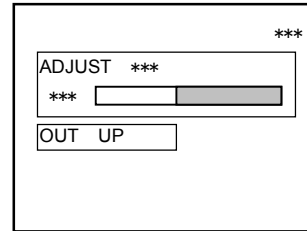

ADJUSTMENT SCREEN

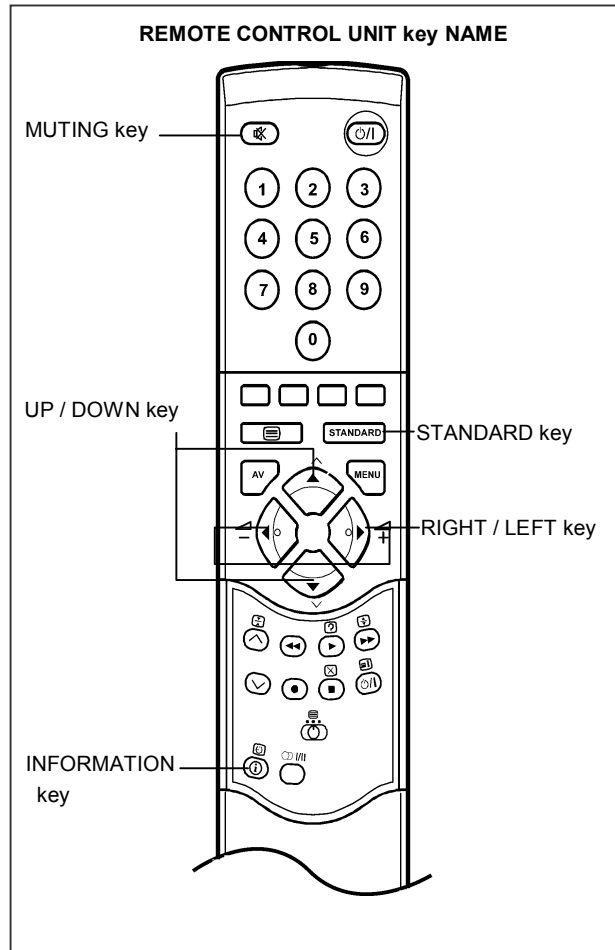

ADJUSTMENTS

Item	Measuring instrument	Test point	Adjustment part	Description
SCREEN VOLTAGE Adjustment	Signal Generator Remote Control unit		SCREEN VR [FBT] OPTION 02	<ol style="list-style-type: none"> 1. Receive a PAL colour bar. 2. Enter the Option settings in the SERVICE MENU. 3. Press the function ▲ / ▼ key, and Enter Option 02. 4. To change bit 6, come on to it by using function ◀ / ▶ and make it "1" by pressing "1" while bit 2 is blinking. 5. Observe the thin horizontal blue-white line in the middle of the screen, and adjust the lower VR of the FBT, until the line is in its thinnest visible thickness. 6. Then make Option 02 bit 6 "0" , by pressing "0" on the remote control unit, although you do not see any picture.
FOCUS Adjustment	Signal generator		FOCUS VR [FBT]	<ol style="list-style-type: none"> 1. Receive a PAL circle pattern. 2. Adjust the upper VR of the FBT, until you get the Optimum focus, the sharpest picture.
B1 VOLTAGE check	DC Voltmeter	Marked [150/115V] on the MAIN PWB		<ol style="list-style-type: none"> 1. Check whether the voltage at the point named and silk screened as "150 / 115V" on the MAIN PWB is 150V DC.

Item	Measuring instruments	Test point	Adjustment part	Description
WHITE BALANCE	Signal generator		ADJUST 00 (White point - RED) ADJUST 01 (White point - GREEN) ADJUST 02 (White point - BLUE)	[LOW LIGHT] 1. Receive a whole black signal. 2. Adjust the <Adjust 00>, <Adjust 01>, <Adjust 02>, in the SERVICE MENU so that the entire screen do not shine black. [HIGH LIGHT] 1. Receive a white and black signal (colour off). 2. Adjust the <Adjust 00>, <Adjust 01>, <Adjust 02>, in the SERVICE MENU so that the whiteness in the screen become sharp.
AGC Adjustment	DC voltmeter		ADJUST 03	1. Receive a any broadcast. 2. Select < ADJUST 03 > from SERVICE MENU 3. Connect a DC voltmeter to pin 1 of the tuner. Change the AGC parameter until you see 3.70VDC on voltmeter display.
IF-PLL NEGATIVE Adjustment			ADJUST 04	1. Select < ADJUST 04 > from SERVICE MENU. 2. Adjustment value is set to 80 as a default value.
IF-PLL POSITIVE Adjustment			ADJUST 05	1. Select < ADJUST 05 > from SERVICE MENU. 2. Adjustment value is set to 80 as a default value.

Item	Measuring instruments	Test point	Adjustment part	Description
LUMINANCE DELAY Adjustment	Signal generator		Adjust 06	<p>[Y-Delay PAL]</p> <ol style="list-style-type: none"> 1. Receive a PAL colour bar signal. 2. Select <Adjust 06> from SERVICE MENU. 3. Adjust Y-Delay PAL till the colour transients on the colour bar of the pattern become as sharper and colours between transients do not mix with each other as possible. <p>Note: If the SAW filter is one of the G1965M, J1951M, K2958M, K2962M, G3957M, K6256K, K6259K or M1963M, there is constant group delay distortion, so for an equal delay of the luminance and chrominance signal the delay must be set at a value of 160nS. This means the adjustment must be set to the maximum value.</p>
			Adjust 07	<p>[Y-Delay SECAM]</p> <ol style="list-style-type: none"> 1. Receive a SECAM colour bar signal. 2. Select <Adjust 07> from SERVICE MENU. 3. Adjust Y-Delay SECAM till the colour transients on the colour bar of the pattern become as sharper and colours between transients do not mix with each other as possible. <p>Note: If the SAW filter is one of the G1965M, K2958M, K2962M, G3957M, K6256K or K6259K, there is constant group delay distortion, so for an equal delay of the luminance and chrominance signal the delay must be set at a value of 160nS. This means the adjustment must be set to the maximum value.</p>
			Adjust 08	<p>[Y-Delay NTSC]</p> <ol style="list-style-type: none"> 1. Receive a NTSC colour bar signal. 2. Select <Adjust 08> from SERVICE MENU. 3. Adjust Y-Delay NTSC till the colour transients on the colour bar of the pattern become as sharper and colours between transients do not mix with each other as possible. <p>Note: If the SAW filter is M1963M, there is constant group delay distortion, so for an equal delay of the luminance and chrominance signal the delay must be set at a value of 160nS. This means the adjustment must be set to the maximum value.</p>

Item	Measuring instruments	Test point	Adjustment part	Description
VERTICAL ZOOM Adjustment	Signal generator		Adjust 10 (4 : 3) Adjust 21 (16 : 9)	<ol style="list-style-type: none"> 1. Receive a PAL circle test pattern. 2. Set < 4 : 3 aspect mode >. 3. Select < ADJUST 10 > from SERVICE MENU. 4. Change vertical zoom till you see the upper and olwer limit of the circle as close to the upper and lower limit of the picture tube as possible. 5. Set < 16 : 9 aspect mode >. 6. Adjusts with the step which is the same above from 3 to 4 about the 16 : 9 aspect mode, too.
VERTICAL SCROLL Adjustment	Signal generator		Adjust 11 (4 : 3) Adjust 22 (16 : 9)	<ol style="list-style-type: none"> 1. Receive a PAL circle test pattern. 2. Set < 4 : 3 aspect mode >. 3. Select < ADJUST 11 > from SERVICE MENU. 4. Change vertical scroll till you see the circle exactly un the middle of the screen. 5. Set < 16 : 9 aspect mode >. 6. Adjusts with the step which is the same above from 3 to 4 about the 16 : 9 aspect mode, too.
4 : 3 HORIZONTAL SHIFT Adjustment	Signal generator		Adjust 12 (4 : 3) Adjust 23 (16 : 9)	<ol style="list-style-type: none"> 1. Receive a RED PURITY test pattern. 2. Set < 4 : 3 aspect mode >. 3. Select < ADJUST 12 > from SERVICE MENU. 4. Change horizontal shift till the picture is horizontally centered. Check whether this adjustment is correct after completing Service Mode Adjustment. 5. Set < 16 : 9 aspect mode >. 6. Adjusts with the step which is the same above from 3 to 4 about the 16 : 9 aspect mode, too.
VERTICAL SLOPE Adjustment	Signal generator		Adjust 13 (4 : 3) Adjust 24 (16 : 9)	<ol style="list-style-type: none"> 1. Receive a CROSS-HATCH signal. 2. Set < 4 : 3 aspect mode >. 3. Select < ADJUST 13 > from SERVICE MENU. 4. Change vertical slope till the size of squares on both the upper and lower part of test pattern become equal to the squares laying on the vertical centre of the test pattern. 5. Check and readjust VERTICAL SLOPE item if the adjustment becomes improper after some other geometric adjustments are done. 6. Set < 16 : 9 aspect mode >. 7. Adjusts with the step which is the same above from 3 to 5 about the 16 : 9 aspect mode, too.
VERTICAL AMPLITUDE Adjustment	Signal generator		Adjust 14 (4 : 3) Adjust 25 (16 : 9)	<ol style="list-style-type: none"> 1. Receive a PAL test pattern signal. 2. Set < 4 : 3 aspect mode >. 3. Select < ADJUST 14 > from SERVICE MENU. 4. Change vertical slope till horizontal black lines on both the upper and lower part of the test pattern become very close to the upper and lower horizontal sides of picture tube and nearly about to disappear. 5. Check and readjust VERTICAL AMPLITUDE item if the adjustment becomes improper after some other geometric adjustments are done. 6. Set < 16 : 9 aspect mode >. 7. Adjusts with the step which is the same above from 3 to 5 about the 16 : 9 aspect mode, too.

Item	Measuring instrument	Test point	Adjustment part	Description
S-CORRECTION Adjustment	Signal generator		Adjust 15 (4 : 3) Adjust 26 (16 : 9)	<ol style="list-style-type: none"> 1. Receive a PAL circle pattern signal. 2. Set < 4 : 3 aspect mode >. 3. Select < ADJUST 15 > from SERVICE MENU. 4. Change S-correction till the middle part of the circle is round as possible. 5. Set < 16 : 9 aspect mode >. 6. Adjusts with the step which is the same above from 3 to 4 about the 16 : 9 aspect mode, too.
VERTICAL SHIFT Adjustment	Signal generator		Adjust 16 (4 : 3) Adjust 27 (16 : 9)	<ol style="list-style-type: none"> 1. Receive a PAL test pattern signal (or the symmetrical signal in the top and the bottom and on either side to find). 2. Set < 4 : 3 aspect mode >. 3. Select < ADJUST 16 > from SERVICE MENU. 4. Change Vertical Shift till the test pattern is vertically centred, i.e. horizontal line at the centre pattern is in equal distance both to upper and lower side of the picture tube. 5. Check and readjust Vertical Shift item if the adjustment becomes improper after some other geometric adjustments are done. 6. Set < 16 : 9 aspect mode >. 7. Adjusts with the step which is the same above from 3 to 5 about the 16 : 9 aspect mode, too.
EW WIDTH Adjustment	Signal generator		Adjust 17 (4 : 3) Adjust 28 (16 : 9)	<ol style="list-style-type: none"> 1. Receive a PAL test pattern signal. 2. Set < 4 : 3 aspect mode >. 3. Select < ADJUST 17 > from SERVICE MENU. 4. Change EW Width till the vertical black and white bars on both left and right side of the pattern exactly disappear. 5. Set < 16 : 9 aspect mode >. 6. Adjusts with the step which is the same above from 3 to 4 about the 16 : 9 aspect mode, too.
EW PARABOLA WIDTH Adjustment	Signal generator		Adjust 18 (4 : 3) Adjust 29 (16 : 9)	<ol style="list-style-type: none"> 1. Receive a PAL test pattern signal. 2. Set < 4 : 3 aspect mode >. 3. Select < ADJUST 18 > from SERVICE MENU. 4. Change EW Parabola Width till vertical lines close to the both sides of the picture frame become parallel to vertical side of picture tube. 5. Check and readjust EW Parabola Width item if the adjustment becomes improper after some other geometric adjustments are done. 6. Set < 16 : 9 aspect mode >. 7. Adjusts with the step which is the same above from 3 to 5 about the 16 : 9 aspect mode, too.
EW CORNER PARABOLA Adjustment	Signal generator		Adjust 19 (4 : 3) Adjust 30 (16 : 9)	<ol style="list-style-type: none"> 1. Receive a PAL test pattern signal. 2. Set < 4 : 3 aspect mode >. 3. Select < ADJUST 19 > from SERVICE MENU. 4. Change EW Corner Parabola till vertical lines at the corners of both sides of picture frame become vertical and parallel to vertical corner sides of picture tube. 5. Check and readjust EW Corner Parabola item if the adjustment becomes improper after some other geometric adjustments are done. 6. Set < 16 : 9 aspect mode >. 7. Adjusts with the step which is the same above from 3 to 5 about the 16 : 9 aspect mode, too.

Item	Measuring instrument	Test point	Adjustment part	Description
EW TRAPEZIUM Adjustment	Signal generator		Adjust 20 (4 : 3) Adjust 31 (16 : 9)	1. Receive a PAL circle pattern signal. 2. Set < 4 : 3 aspect mode >. 3. Select < ADJUST 15 > from SERVICE MENU. 4. Change EW Trapezium till vertical lines, especially lines at the sides of the picture frame became parallel to the both sides of picture tube as possible. 5. Check and readjust EW Trapezium item if the adjustment becomes improper after some other geometric adjustment. 6. Set < 16 : 9 aspect mode >. 7. Adjusts with the step which is the same above from 3 to 5 about the 16 : 9 aspect mode, too.



JVC

VICTOR COMPANY OF JAPAN, LIMITED

HOME AV NETWORK BUSINESS UNIT 12, 3-chome, Moriya-cho, Kanagawa-ku, Yokohama, Kanagawa-prefecture, 221-8528, Japan



VP 0112
DP205180