

N-Channel Power MOSFET

10A, 400V, 0.55Ω

General Description

The N-Channel MOSFET is used an advanced termination scheme to provide enhanced voltage-blocking capability without degrading performance over time. This advanced technology has been especially tailored to minimize on-state resistance, provide superior switching performance. This device is well suited for high efficiency switched mode power suppliers, active power factor correction, electronic lamp ballasts based half bridge topology.

Features

- Robust high voltage termination
- Avalanche energy specified
- Diode is characterized for use in bridge circuits
- Source to Drain diode recovery time comparable to a discrete fast recovery diode.

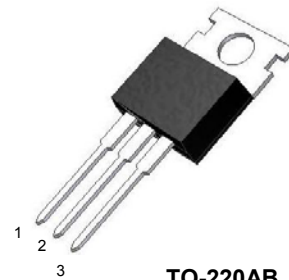

1 = Gate
2 = Drain
3 = Source

TO-220AB

DEVICE MARKING DIAGRAM

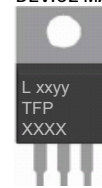

L = Tak Cheong Logo
xxyy = Monthly Date Code
TFPXXXX = Device Type

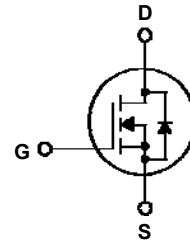

ABSOLUTE MAXIMUM RATINGS (T_C=25°C, unless otherwise noted)

Symbol	Parameter	Value	Units
V _{DSS}	Drain- Source Voltage	400	V
V _{GSS}	Gate-Source Voltage	±30	V
I _D	Drain Current	10	A
I _{DM}	Drain Current Pulsed	40	A
P _D	Power Dissipation (Note 2)	125	W
	Derating factor above 25°C	1.0	W/°C
E _{AS}	Single Pulsed Avalanche Energy (Note 1)	680	mJ
E _{AR}	Repetitive Avalanche Energy (Note 2)	12.5	mJ
T _J	Operating Junction Temperature	150	°C
T _{stg}	Storage Temperature Range	- 55 to +150	°C

Notes:

1. L=18.5mH, I_{AS}=10A, V_{DD}=50V, R_G=50 Ω, Starting T_J=25°C
2. Repetitive Rating: Pulse width limited by maximum junction temperature.

THERMAL CHARACTERISTICS

Symbol	Parameter	Value	Unit
R _{θJC}	Thermal Resistance, Junction-to-Case	1	°C/W
R _{θJA}	Thermal Resistance, Junction-to-Ambient	62	°C/W

ELECTRICAL CHARACTERISTICS
Off Characteristics ($T_A = 25^\circ\text{C}$ unless otherwise noted)

Symbol	Parameter	Test Conditions	Min.	Typ.	Max.	Unit
BV_{DSS}	Drain-Source Breakdown Voltage	$V_{GS} = 0V, I_D = 250\mu A$	400	--	--	V
I_{DSS}	Zero Gate Voltage Drain Current	$V_{DS} = 400V, V_{GS} = 0V$	--	--	1	μA
I_{GSSF}	Gate-Body Leakage Current, Forward	$V_{GS} = 30V, V_{DS} = 0V$	--	--	100	nA
I_{GSSR}	Gate-Body Leakage Current, Reverse	$V_{GS} = -30V, V_{DS} = 0V$	--	--	-100	nA

On Characteristics ($T_A = 25^\circ\text{C}$ unless otherwise noted)

Symbol	Parameter	Test Conditions	Min.	Typ.	Max.	Unit
$V_{GS(th)}$	Gate Threshold Voltage	$V_{DS} = V_{GS}, I_D = 250\mu A$	2.0	--	4.0	V
$R_{DS(on)}$	On-Resistance	$V_{GS} = 10V, I_D = 5A$	--	0.41	0.55	Ω

Dynamic Characteristics

Symbol	Parameter	Test Conditions	Min.	Typ.	Max.	Unit
C_{iss}	Input Capacitance	$V_{DS} = 25V, V_{GS} = 0V,$ $f = 1.0\text{MHz}$	--	830	--	pF
C_{oss}	Output Capacitance		--	140	--	pF
C_{rss}	Reverse Transfer Capacitance		--	40	--	pF

Switching Characteristics

Symbol	Parameter	Test Conditions	Min.	Typ.	Max.	Unit
$t_{d(on)}$	Turn-On Delay Time	$V_{DD} = 250V, I_D = 10A,$ $R_G = 50\Omega$ (Note 3 & 4)	--	22	--	nS
t_r	Turn-On Rise Time		--	25	--	nS
$t_{d(off)}$	Turn-Off Delay Time		--	130	--	nS
t_f	Turn-Off Fall Time		--	30	--	nS
Q_g	Total Gate Charge	$V_{DS} = 320V, I_D = 10A,$ $V_{GS} = 10V$ (Note 3 & 4)	--	48	--	nC
Q_{gs}	Gate-Source Charge		--	7	--	nC
Q_{gd}	Gate-Drain Charge		--	20	--	nC

Drain-Source Diode Characteristics and Maximum Ratings

Symbol	Parameter	Test Conditions	Min.	Typ.	Max.	Unit
I_S	Maximum Continuous Drain-Source Diode Forward Current		--	--	10	A
I_{SM}	Maximum Pulsed Drain-Source Diode Forward Current		--	--	40	A
V_{SD}	Drain-Source Diode Forward Voltage	$V_{GS} = 0V, I_S = 10A$	--	--	1.5	V
T_{rr}	Reverse Recovery Time	$V_{GS} = 0V, I_S = 10A,$ $di_F / dt = 100A/\mu S$ (Note 3)	--	335	--	nS
Q_{rr}	Reverse Recovery Charge		--	3.6	--	μC

Notes:

- Pulse Test: Pulse width < 300 μs , Duty cycle $\leq 2\%$.
- Basically not affected by working temperature.

TYPICAL CHARACTERISTICS
Fig 1. On-State Characteristics

Fig 2. Transfer Characteristics

Fig 3. On Resistance Variation vs. Drain Current and Gate Voltage

Fig 4. On State Current vs. Allowable Case Temperature

Fig 5. Capacitance Characteristics

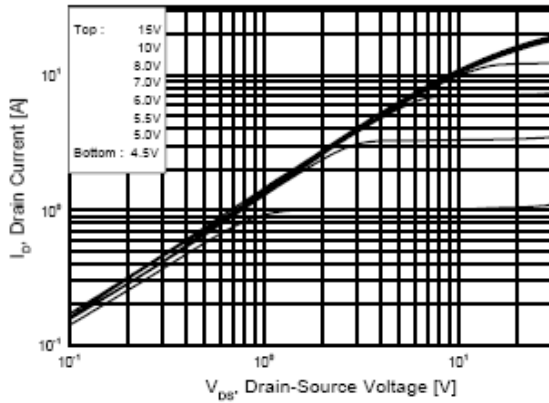
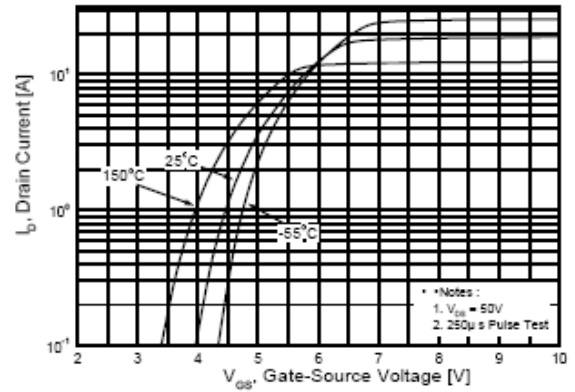
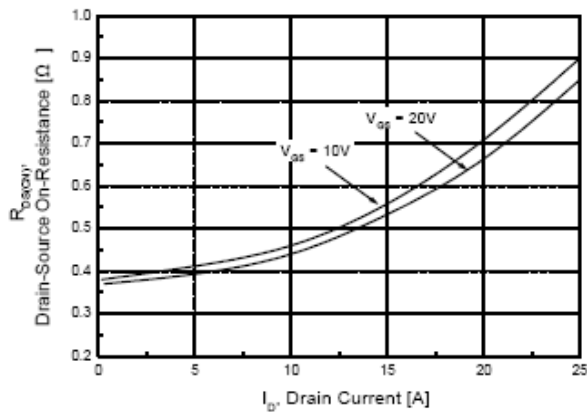
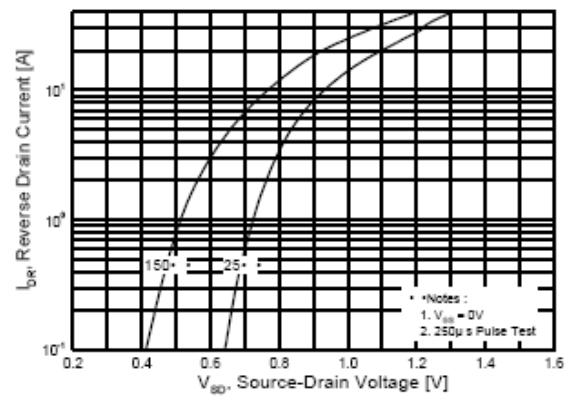
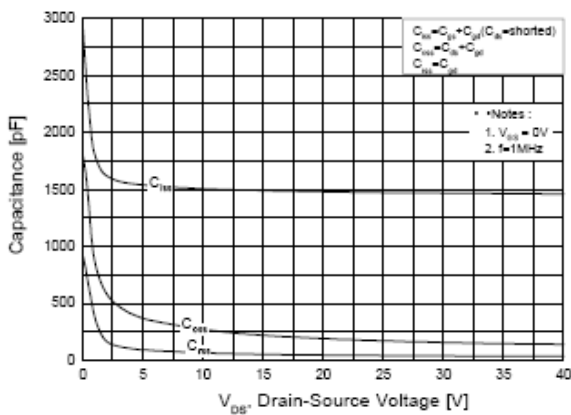
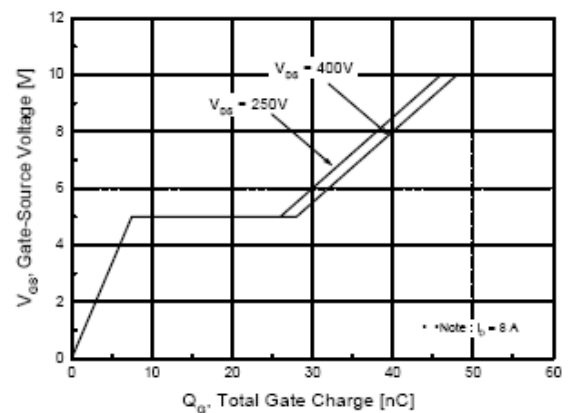
Fig 6. Gate Charge Characteristics

Fig 7. Breakdown Voltage Variation

Fig 8. On-Resistance Variation

Fig 9. Maximum Safe Operating Area

Fig 10. Maximum Drain Current vs. Case Temperature

Fig 11. Transient Thermal Response Curve

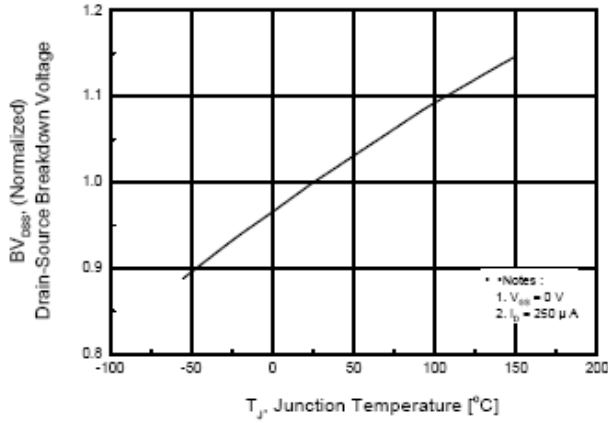
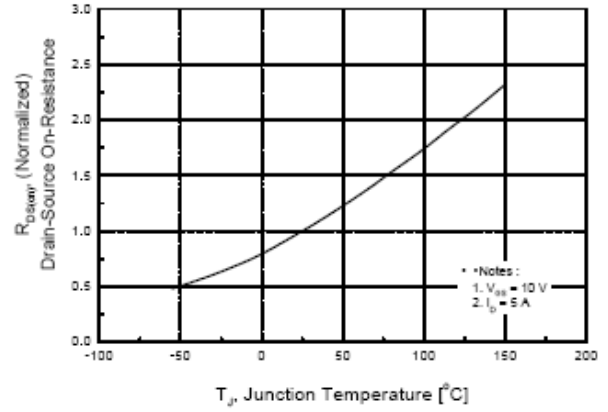
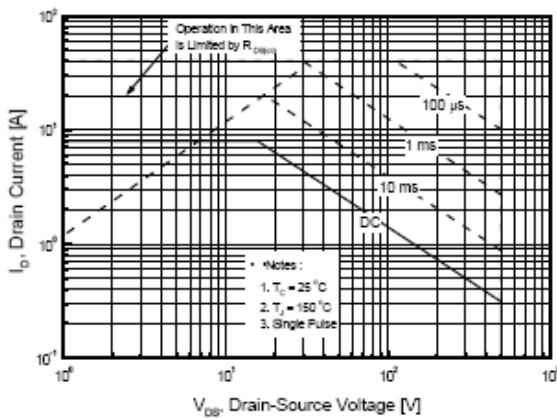
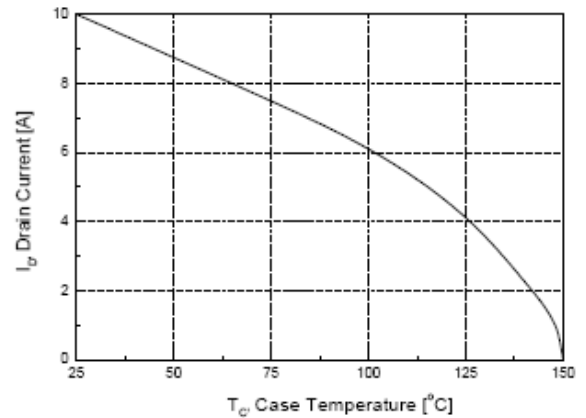
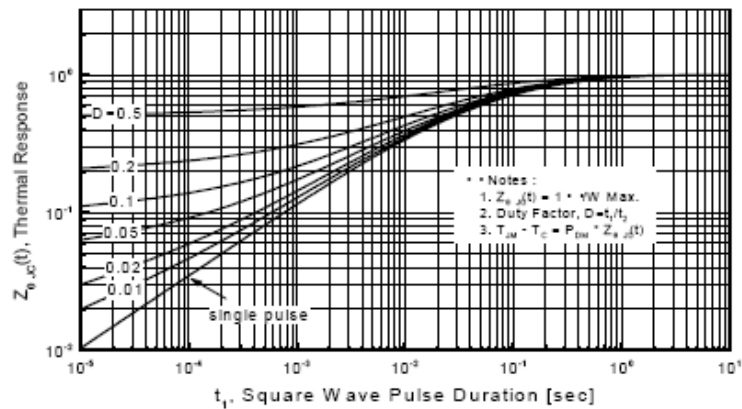
Fig. 12. Gate Charge Test Circuit & Waveforms

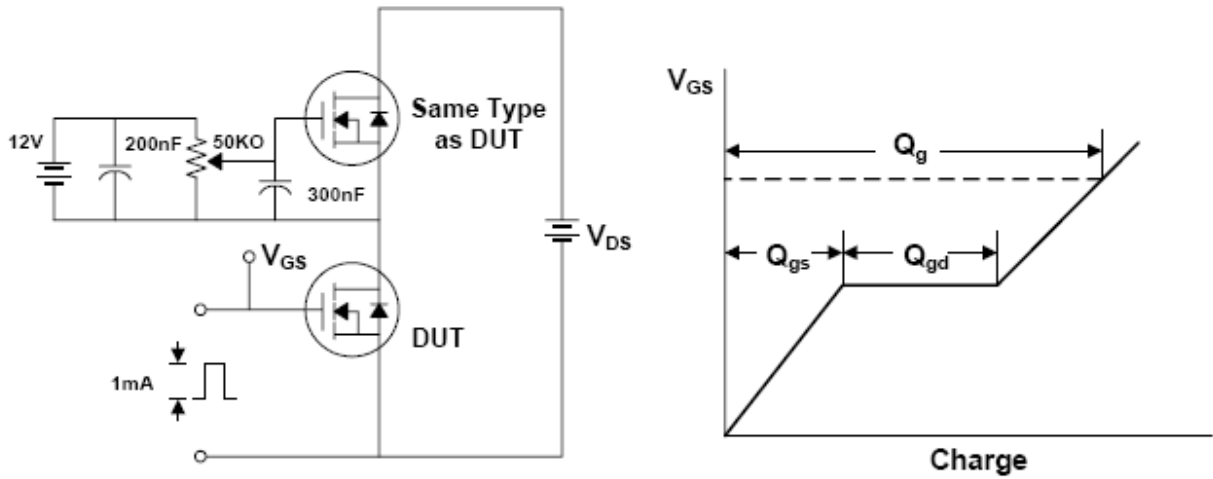

Fig 13. Switching Time Test Circuit & Waveforms

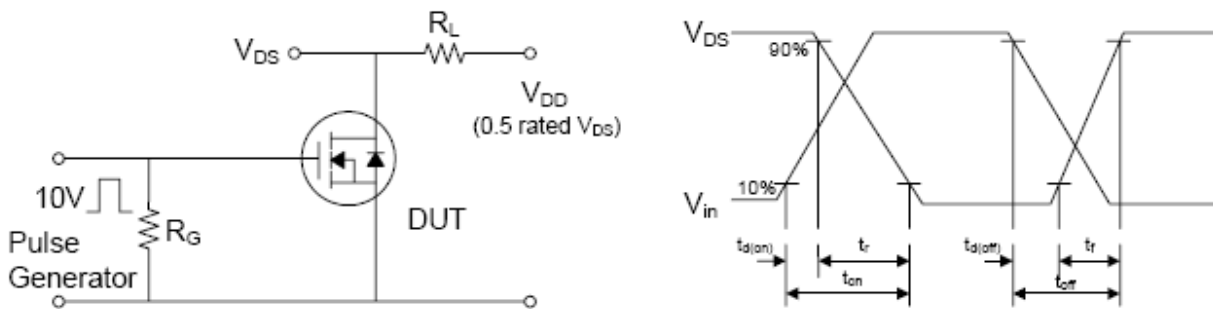
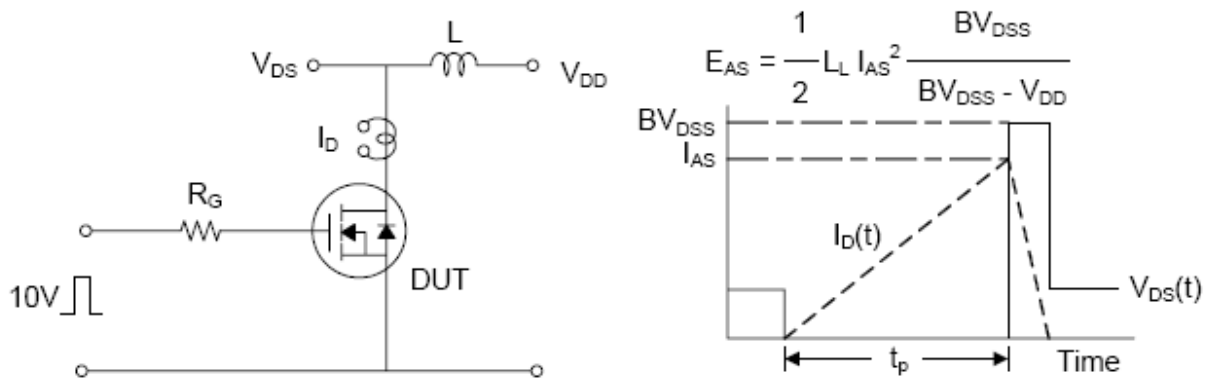
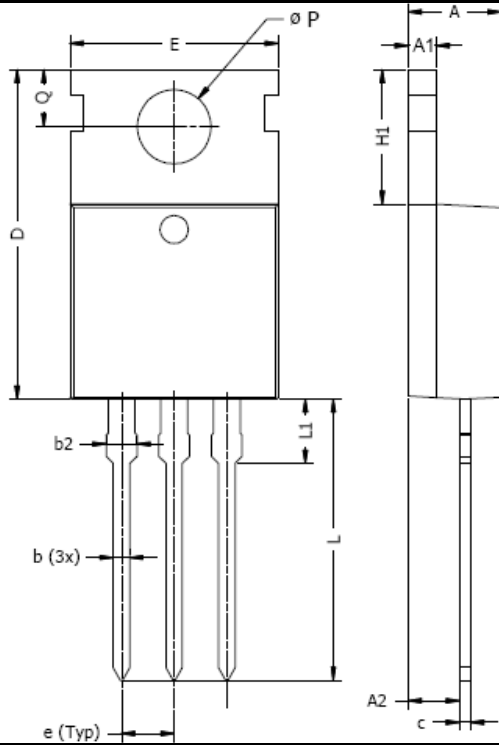

Fig 14. Unclamped Inductive Switching Test Circuit & Waveforms



TO220AB PACKAGE OUTLINE



DIM	MILLIMETERS		INCHES	
	MIN	MAX	MIN	MAX
A	3.60	4.80	0.142	0.189
A1	1.20	1.40	0.047	0.055
A2	2.03	2.90	0.080	0.114
b	0.40	1.00	0.016	0.039
b2	1.20	1.78	0.047	0.070
c	0.36	0.60	0.014	0.024
D	14.22	16.50	0.560	0.650
e	2.34	2.74	0.092	0.108
E	9.70	10.60	0.382	0.417
H1	5.84	6.85	0.230	0.270
L	12.70	14.70	0.500	0.579
L1	2.70	3.30	0.106	0.130
ØP	3.50	4.00	0.138	0.157
Q	2.54	3.40	0.100	0.134

NOTE: Above package outline conforms to JEDEC TO-220AB

NOTICE

The information presented in this document is for reference only. Tak Cheong reserves the right to make changes without notice for the specification of the products displayed herein.

The product listed herein is designed to be used with ordinary electronic equipment or devices, and not designed to be used with equipment or devices which require high level of reliability and the malfunction of which would directly endanger human life (such as medical instruments, transportation equipment, aerospace machinery, nuclear-reactor controllers, fuel controllers and other safety devices), Tak Cheong Semiconductor Co., Ltd., or anyone on its behalf, assumes no responsibility or liability for any damages resulting from such improper use of sale.

This publication supersedes & replaces all information previously supplied. For additional information, please visit our website <http://www.takcheong.com>, or consult your nearest Tak Cheong's sales office for further assistance.