

Features

- Wide Voltage Range: 2.7V to 3.6V
- Ultra Low Active Power
- Low Standby Power
- TTL-compatible Inputs and Outputs
- Automatic Power Down when deselected
- CMOS for optimum Speed and Power
- Package available in a 32-Pin TSOP II and a 32-Pin SOIC Package

Functional Description

The CY62148VN is a high performance CMOS static RAM organized as 512K words by eight bits. This device features advanced circuit design to provide ultra-low active current. This is ideal for providing More Battery Life™ (MoBL®) in portable

applications such as cellular telephones. The device also has an automatic power down feature that significantly reduces power consumption by 99 percent when addresses are not toggling. The device can be put into standby mode when deselected (CE HIGH).

Writing to the device is accomplished by taking Chip Enable (\overline{CE}) and Write Enable (\overline{WE}) inputs LOW. Data on the eight I/O pins (I/O₀ through I/O₇) is then written into the location specified on the address pins (A₀ through A₁₈).

Reading from the device is accomplished by taking Chip Enable (\overline{CE}) and Output Enable (\overline{OE}) LOW while forcing Write Enable (\overline{WE}) HIGH. Under these conditions, the contents of the memory location specified by the address pins appear on the I/O pins.

The eight input/output pins (I/O₀ through I/O₇) are placed in a high impedance state when the device is deselected (CE HIGH), the outputs are disabled (OE HIGH), or during a write operation (CE LOW and WE LOW).

For best practice recommendations, refer to the Cypress application note [AN1064, SRAM System Guidelines](#).

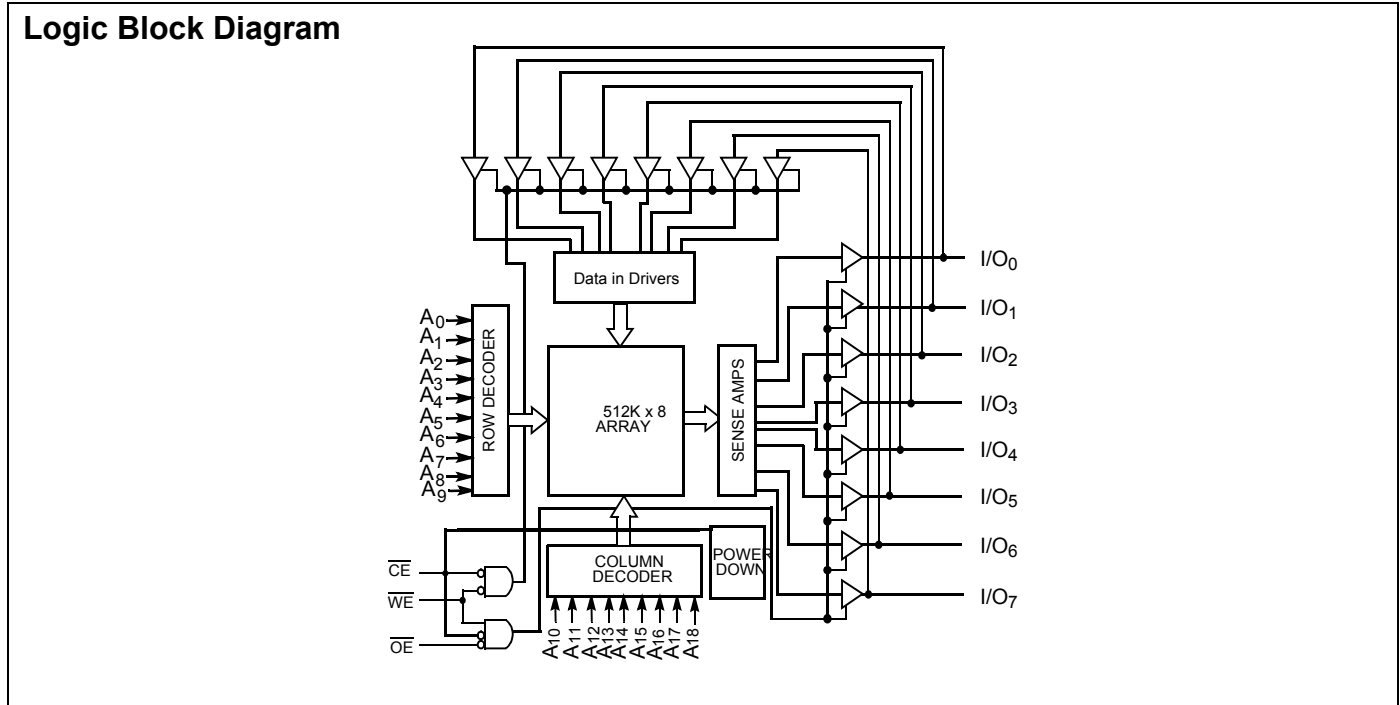

Pin Configuration

Figure 1. 32-Pin TSOP II/SOIC (Top View)

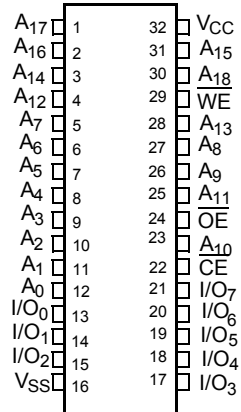

Product Portfolio

Product	V _{CC} Range (V)			Speed (ns)	Power Dissipation			
	Min	Typ ^[1]	Max		Operating I _{CC} (mA)		Standby I _{SB2} (μA)	
					Typ ^[1]	Max	Typ ^[1]	Max
CY62148VNLL	2.7	3.0	3.6	70	7	15	2	20

Note

1. Typical values are included for reference only and are not guaranteed or tested. Typical values are measured at V_{CC} = V_{CC(typ.)}, T_A = 25°C.

Maximum Ratings

Exceeding the maximum ratings may impair the useful life of the device. User guidelines are not tested.

Storage Temperature -65°C to +150°C
 Ambient Temperature with
 Power Applied 55°C to +125°C
 Supply Voltage to Ground Potential..... -0.5V to +4.6V
 DC Voltage Applied to Outputs
 in High-Z State^[2]..... -0.5V to $V_{CC} + 0.5V$

DC Input Voltage^[2] -0.5V to $V_{CC} + 0.5V$
 Output Current into Outputs (LOW)..... 20 mA
 Static Discharge Voltage..... > 2001V
 (per MIL-STD-883, Method 3015)
 Latch up Current..... > 200 mA

Operating Range

Range	Ambient Temperature	V_{CC}
Industrial	-40°C to +85°C	2.7V to 3.6V

Electrical Characteristics

Over the Operating Range

Parameter	Description	Test Conditions	CY62148VN-70			Unit
			Min.	Typ. ^[1]	Max.	
V_{OH}	Output HIGH Voltage	$I_{OH} = -1.0 \text{ mA}$ $V_{CC} = 2.7V$	2.4			V
V_{OL}	Output LOW Voltage	$I_{OL} = 2.1 \text{ mA}$ $V_{CC} = 2.7V$			0.4	V
V_{IH}	Input HIGH Voltage	$V_{CC} = 3.6V$	2.2		$V_{CC} + 0.5V$	V
V_{IL}	Input LOW Voltage	$V_{CC} = 2.7V$	-0.5		0.8	V
I_{IX}	Input Load Current	$GND \leq V_I \leq V_{CC}$	-1	+1	+1	μA
I_{OZ}	Output Leakage Current	$GND \leq V_O \leq V_{CC}$, Output Disabled	-1	+1	+1	μA
I_{CC}	V_{CC} Operating Supply Current	$I_{OUT} = 0 \text{ mA}$, $f = f_{MAX} = 1/t_{RC}$ CMOS Levels $V_{CC} = 3.6V$		7	15	mA
		$I_{OUT} = 0 \text{ mA}$, $f = 1 \text{ MHz}$ CMOS Levels		1	2	mA
I_{SB1}	Automatic CE Power down Current—CMOS Inputs	$CE \geq V_{CC} - 0.3V$, $V_{IN} \geq V_{CC} - 0.3V$ or $V_{IN} \leq 0.3V$, $f = f_{MAX}$		2	20	μA
I_{SB2}	Automatic CE Power down Current—CMOS Inputs	$CE \geq V_{CC} - 0.3V$ $V_{IN} \geq V_{CC} - 0.3V$ or $V_{IN} \leq 0.3V$, $f = 0$ $V_{CC} = 3.6V$				

Capacitance

Tested initially and after any design or process changes that may affect these parameters.

Parameter	Description	Test Conditions	Max	Unit
C_{IN}	Input Capacitance	$T_A = 25^\circ\text{C}$, $f = 1 \text{ MHz}$, $V_{CC} = 3.0V$	6	pF
C_{OUT}	Output Capacitance		8	pF

Thermal Resistance

Tested initially and after any design or process changes that may affect these parameters.

Parameter	Description	Test Conditions	TSOP II	SOIC	Unit
Θ_{JA}	Thermal Resistance (Junction to Ambient)	Still Air, soldered on a 4.25 x 1.125 inch, four-layer printed circuit board	TBD	TBD	$^\circ\text{C/W}$
Θ_{JC}	Thermal Resistance (Junction to Case)		TBD	TBD	$^\circ\text{C/W}$

Note

2. $V_{IL(\text{min.})} = -2.0V$ for pulse durations less than 20 ns.

Figure 2. AC Test Loads and Waveforms

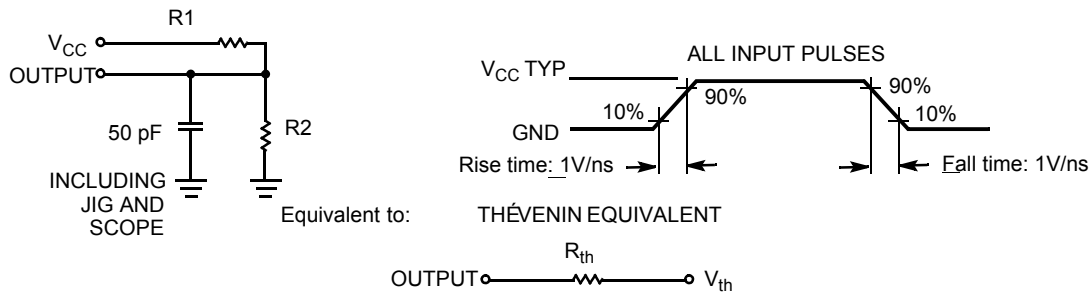

Parameters	3.0V	Unit
R1	1105	Ω
R2	1550	Ω
R _{TH}	645	Ω
V _{TH}	1.75V	V

Data Retention Characteristics

Over the Operating Range

Parameter	Description	Conditions	Min.	Typ. ^[1]	Max.	Unit
V _{DR}	V _{CC} for Data Retention		1.0		3.6	V
I _{CCDR}	Data Retention Current	V _{CC} = 1.0V, CE ≥ V _{CC} - 0.3V, V _{IN} ≥ V _{CC} - 0.3V or V _{IN} ≤ 0.3V; No input may exceed V _{CC} + 0.3V		0.2	5.5	μA
t _{CDR} ^[3]	Chip Deselect to Data Retention Time		0			ns
t _R ^[4]	Operation Recovery Time		t _{RC}			ns

Figure 3. Data Retention Waveform

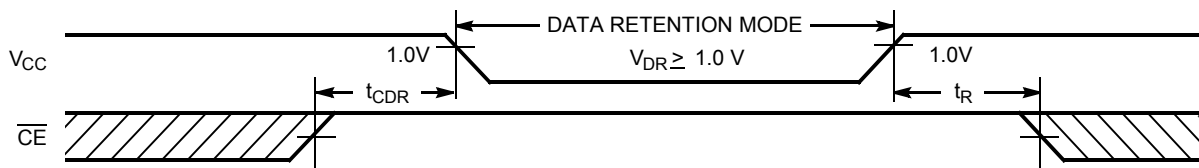

Notes

- 3. Tested initially and after any design or process changes that may affect these parameters.
- 4. Full-device AC operation requires linear V_{CC} ramp from V_{DR} to V_{CC(min.)} ≥ 10 μs or stable at V_{CC(min.)} ≥ 10 μs.

Switching Characteristics

Over the Operating Range^[5]

Parameter	Description	70 ns		Unit
		Min	Max	
Read Cycle				
t_{RC}	Read Cycle Time	70		ns
t_{AA}	Address to Data Valid		70	ns
t_{OHA}	Data Hold from Address Change	10		ns
t_{ACE}	\overline{CE} LOW to Data Valid		70	ns
t_{DOE}	\overline{OE} LOW to Data Valid		35	ns
t_{LZOE}	\overline{OE} LOW to Low Z ^[6]	5		ns
t_{HZOE}	\overline{OE} HIGH to High Z ^[7]		25	ns
t_{LZCE}	\overline{CE} LOW and to Low Z ^[6]	10		ns
t_{HZCE}	\overline{CE} HIGH to High Z ^[6, 7]		25	ns
t_{PU}	\overline{CE}_1 LOW and CE_2 HIGH to Power Up	0		ns
t_{PD}	\overline{CE}_1 HIGH and CE_2 LOW to Power Down		70	ns
Write Cycle^[8, 9]				
t_{WC}	Write Cycle Time	70		ns
t_{SCE}	\overline{CE}_1 LOW and CE_2 HIGH to Write End	60		ns
t_{AW}	Address Setup to Write End	60		ns
t_{HA}	Address Hold from Write End	0		ns
t_{SA}	Address Setup to Write Start	0		ns
t_{PWE}	\overline{WE} Pulse Width	50		ns
t_{SD}	Data Setup to Write End	30		ns
t_{HD}	Data Hold from Write End	0		ns
t_{HZWE}	\overline{WE} LOW to High Z ^[6, 7]		25	ns
t_{LZWE}	\overline{WE} HIGH to Low Z ^[6]	10		ns

Notes

- Test conditions assume signal transition time of 5 ns or less, timing reference levels of 1.5V, input pulse levels of 0 to $V_{CC(typ.)}$, and output loading of the specified I_{OL}/I_{OH} and 30 pF load capacitance.
- At any given temperature and voltage condition, t_{HZCE} is less than t_{LZCE} , t_{HZOE} is less than t_{LZOE} , and t_{HZWE} is less than t_{LZWE} for any given device.
- t_{HZOE} , t_{HZCE} , and t_{HZWE} are specified with $C_L = 5$ pF as in (b) of AC Test Loads. Transition is measured ± 200 mV from steady-state voltage.
- The internal write time of the memory is defined by the overlap of \overline{CE} LOW and \overline{WE} LOW. Both signals must be LOW to initiate a write and either signal can terminate a write by going HIGH. The data input set-up and hold timing should be referenced to the rising edge of the signal that terminates the write.
- The minimum write cycle time for Write Cycle #3 (\overline{WE} controlled, \overline{OE} LOW) is the sum of t_{HZWE} and t_{SD} .

Switching Waveforms

Figure 4. Read Cycle No. 1: Address Transition Controlled [10, 11]

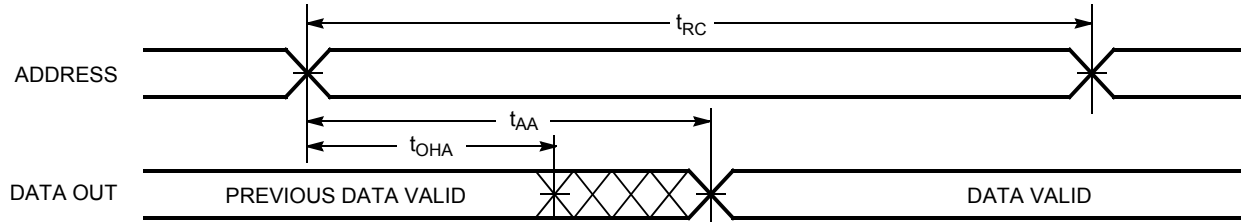

Figure 5. Read Cycle No. 2: \overline{OE} Controlled [11, 12]

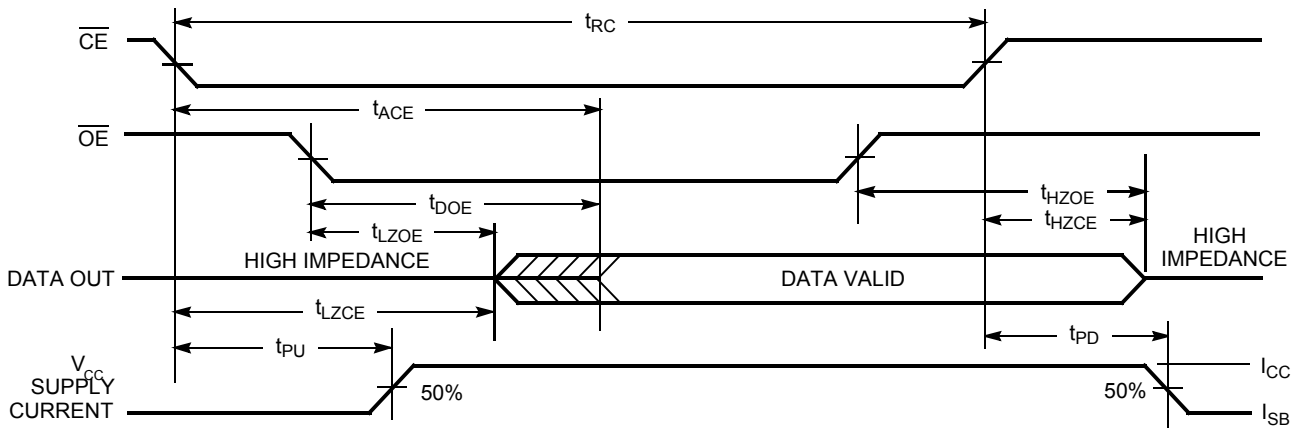
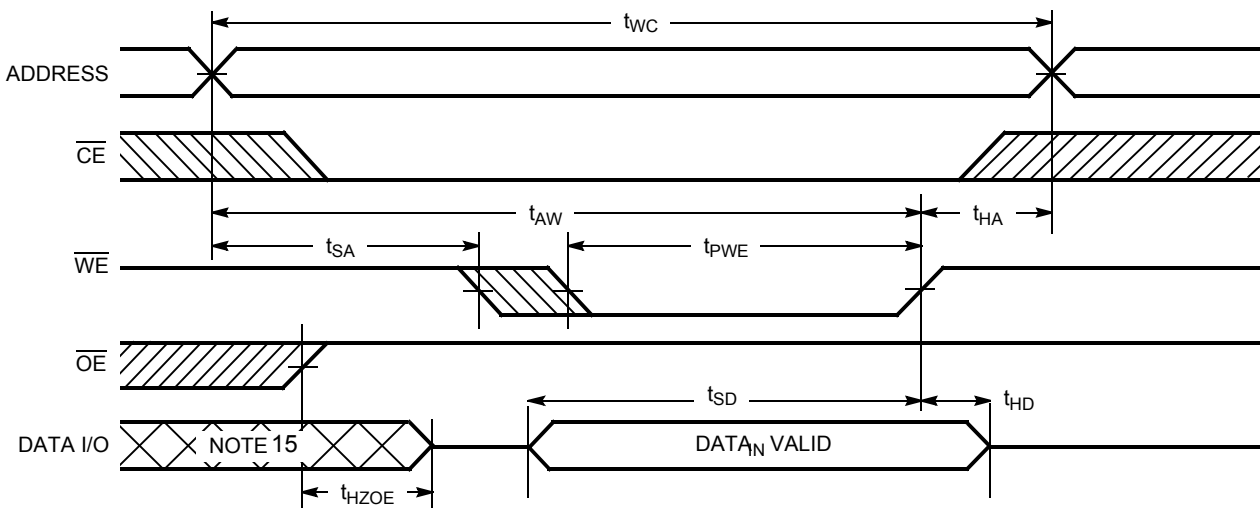

Figure 6. Write Cycle No 1: \overline{WE} Controlled [8, 13, 14]



Notes

- 10. The device is continuously selected. \overline{OE} , $\overline{CE} = V_{IL}$.
- 11. WE is HIGH for read cycle.
- 12. Address valid before or similar to \overline{CE} transition LOW.
- 13. Data I/O is high impedance if $\overline{OE} = V_{IH}$.
- 14. If CE goes HIGH simultaneously with WE = V_{IH} , the output remains in a high impedance state.

Switching Waveforms (continued)

Figure 7. Write Cycle 2: $\overline{\text{CE}}$ Controlled [8, 13, 14]

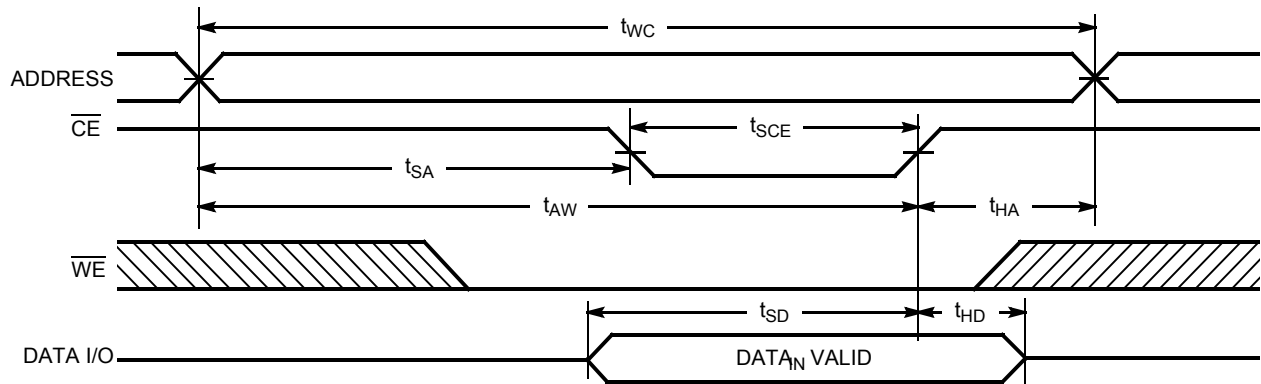
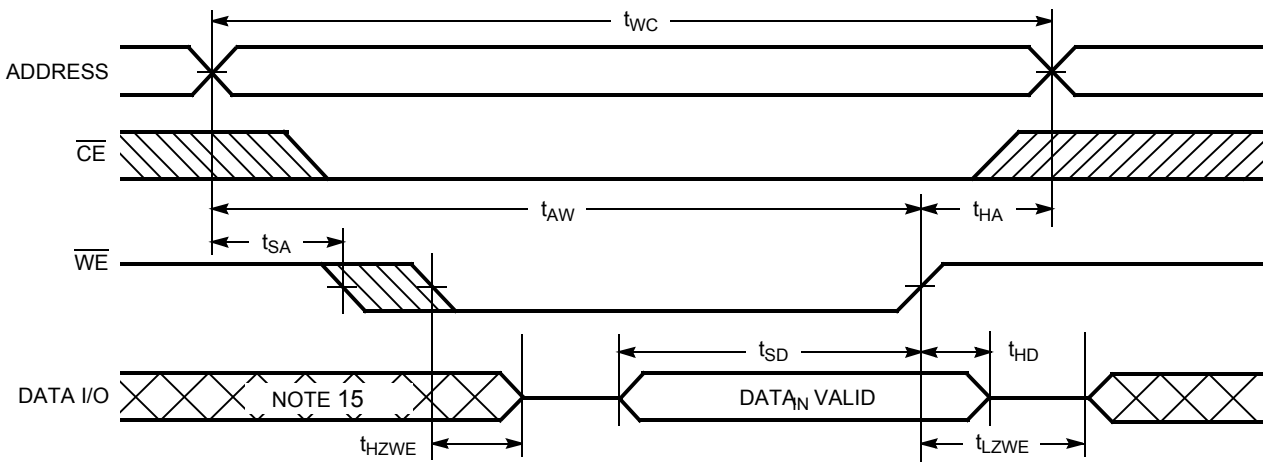
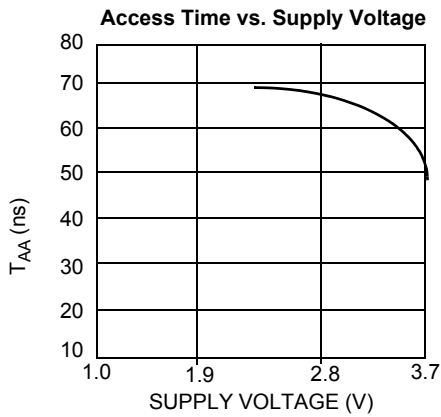
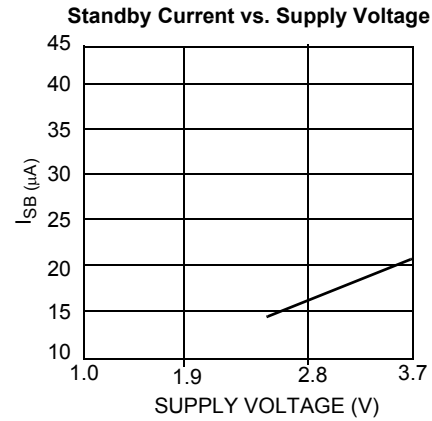
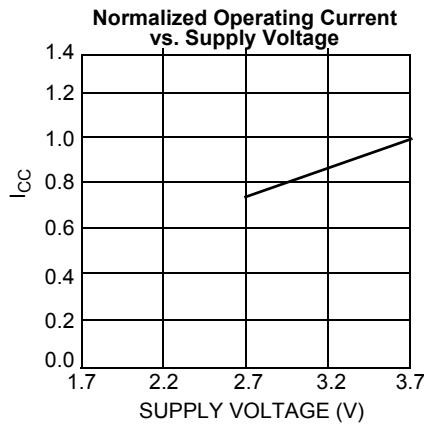

Figure 8. Write Cycle 3: $\overline{\text{WE}}$ controlled, $\overline{\text{OE}}$ LOW [14]



Note
15. During this period, the I/Os are in output state. Do not apply input signals.

Typical DC and AC Characteristics



Truth Table

\overline{CE}	\overline{WE}	\overline{OE}	Inputs/Outputs	Mode	Power
H	X	X	High-Z	Deselect/Power down	Standby (I_{SB})
L	H	L	Data Out	Read	Active (I_{CC})
L	L	X	Data In	Write	Active (I_{CC})
L	H	H	High-Z	Output Disabled	Active (I_{CC})

Ordering Information

Speed (ns)	Ordering Code	Package Name	Package Type	Operating Range
70	CY62148VNLL-70ZSXI	51-85095	32-Pin TSOP II	Industrial

Package Diagrams

Figure 9. 32-Pin TSOP II, 51-85095

32 Lead TSOP TYPE II

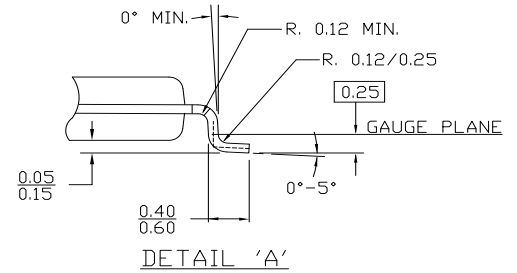
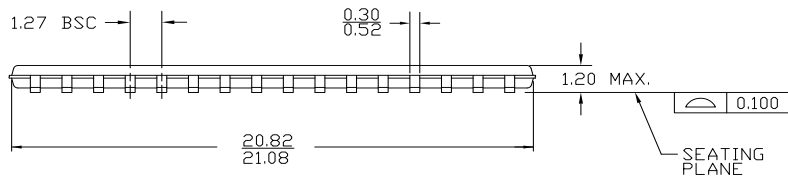
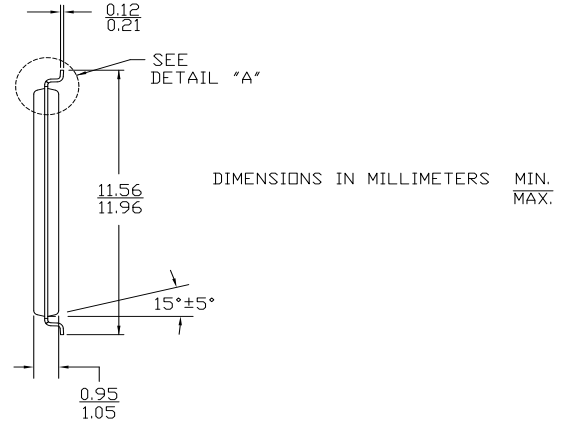
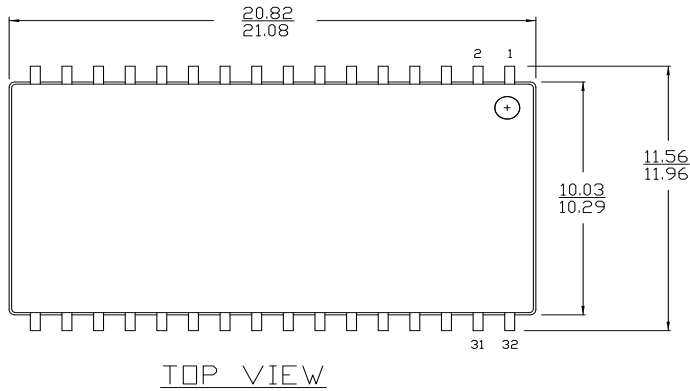

51-85095 *A

Document History Page

Document Title: CY62148VN MoBL®, 4 Mbit (512K x 8) Static RAM Document Number: 001-55636				
Rev.	ECN No.	Orig. of Change	Submission Date	Description of Change
**	2761558	VKN	09/09/2009	New data sheet
*A	2905443	VKN	06/04/2010	Removed inactive part CY62148VNLL-70SXI from ordering information. Updated Package Diagrams.

Sales, Solutions, and Legal Information

Worldwide Sales and Design Support

Cypress maintains a worldwide network of offices, solution centers, manufacturer's representatives, and distributors. To find the office closest to you, visit us at cypress.com/sales.

Products

PSoC	psoc.cypress.com
Clocks & Buffers	clocks.cypress.com
Wireless	wireless.cypress.com
Memories	memory.cypress.com
Image Sensors	image.cypress.com

© Cypress Semiconductor Corporation, 2009-2010. The information contained herein is subject to change without notice. Cypress Semiconductor Corporation assumes no responsibility for the use of any circuitry other than circuitry embodied in a Cypress product. Nor does it convey or imply any license under patent or other rights. Cypress products are not warranted nor intended to be used for medical, life support, life saving, critical control or safety applications, unless pursuant to an express written agreement with Cypress. Furthermore, Cypress does not authorize its products for use as critical components in life-support systems where a malfunction or failure may reasonably be expected to result in significant injury to the user. The inclusion of Cypress products in life-support systems application implies that the manufacturer assumes all risk of such use and in doing so indemnifies Cypress against all charges.

Any Source Code (software and/or firmware) is owned by Cypress Semiconductor Corporation (Cypress) and is protected by and subject to worldwide patent protection (United States and foreign), United States copyright laws and international treaty provisions. Cypress hereby grants to licensee a personal, non-exclusive, non-transferable license to copy, use, modify, create derivative works of, and compile the Cypress Source Code and derivative works for the sole purpose of creating custom software and or firmware in support of licensee product to be used only in conjunction with a Cypress integrated circuit as specified in the applicable agreement. Any reproduction, modification, translation, compilation, or representation of this Source Code except as specified above is prohibited without the express written permission of Cypress.

Disclaimer: CYPRESS MAKES NO WARRANTY OF ANY KIND, EXPRESS OR IMPLIED, WITH REGARD TO THIS MATERIAL, INCLUDING, BUT NOT LIMITED TO, THE IMPLIED WARRANTIES OF MERCHANTABILITY AND FITNESS FOR A PARTICULAR PURPOSE. Cypress reserves the right to make changes without further notice to the materials described herein. Cypress does not assume any liability arising out of the application or use of any product or circuit described herein. Cypress does not authorize its products for use as critical components in life-support systems where a malfunction or failure may reasonably be expected to result in significant injury to the user. The inclusion of Cypress' product in a life-support systems application implies that the manufacturer assumes all risk of such use and in doing so indemnifies Cypress against all charges.

Use may be limited by and subject to the applicable Cypress software license agreement.