

CM500HA-34A



Single

- I_C 500 A
- V_{CES} 1700 V
- Flat base Type
 Copper (non-plating) base plate
 No accessory (terminal screw) attach
- RoHS Directive compliant

APPLICATION

AC Motor Control, Motion/Servo Control, Power supply, etc.

OUTLINE DRAWING & INTERNAL CONNECTION

Dimension in mm

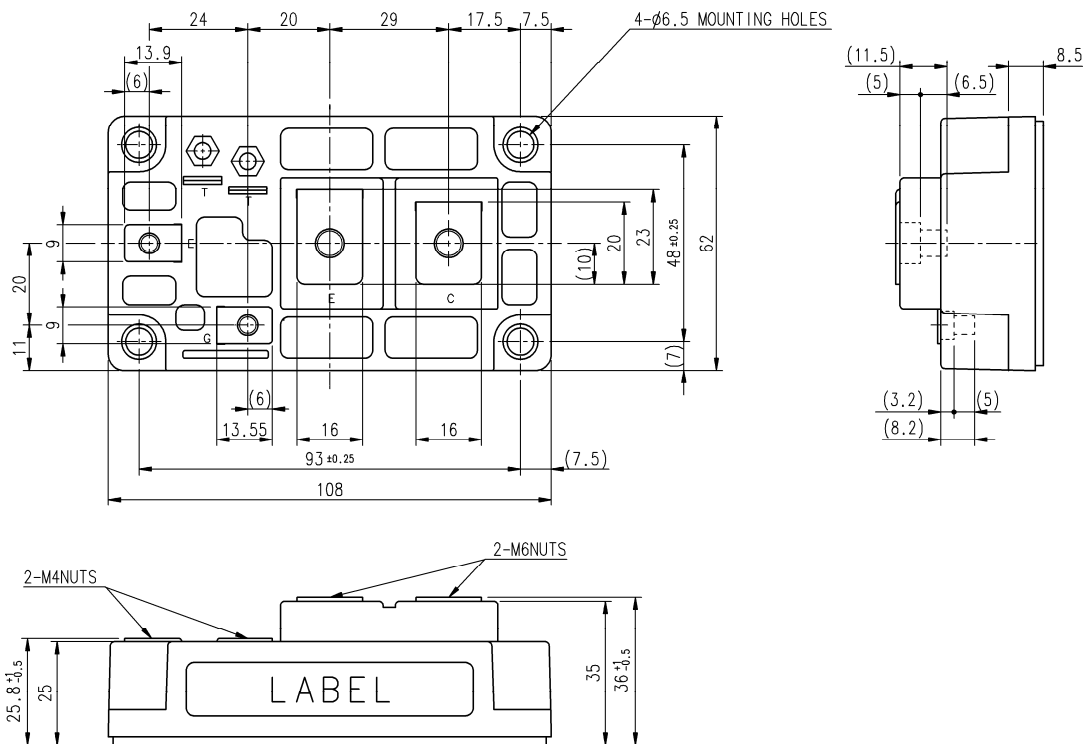

Tolerance otherwise specified	
Division of Dimension	Tolerance
0.5 to 3	±0.2
over 3 to 6	±0.3
over 6 to 30	±0.5
over 30 to 120	±0.8
over 120 to 400	±1.2

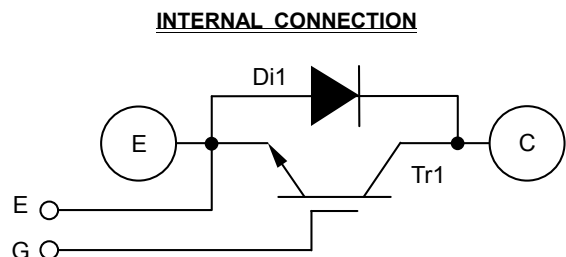

ABSOLUTE MAXIMUM RATINGS (T_j=25 °C, unless otherwise specified)

Symbol	Item	Conditions	Rating	Unit
V _{CES}	Collector-emitter voltage	G-E short-circuited	1700	V
V _{GES}	Gate-emitter voltage	C-E short-circuited	±20	V
I _C	Collector current	DC, T _C =87 °C (Note.2)	500	A
I _{CRM}		Pulse, Repetitive (Note.3)	1000	
P _{tot}	Total power dissipation	T _C =25 °C (Note.2, 4)	5000	W
I _E (Note.1)	Emitter current (Free wheeling diode forward current)	T _C =25 °C (Note.2, 4)	500	A
I _{ERM} (Note.1)		Pulse, Repetitive (Note.3)	1000	
T _j	Junction temperature	-	-40 ~ +150	°C
T _{stg}	Storage temperature	-	-40 ~ +125	
V _{isol}	Isolation voltage	Terminals to base plate, RMS, f=60 Hz, AC 1 min	3500	V

MECHANICAL CHARACTERISTICS

Symbol	Item	Conditions	Limits			Unit
			Min.	Typ.	Max.	
M _t	Mounting torque	Main terminals M 6 screw	1.96	2.45	2.94	N·m
M _t		Auxiliary terminals M 4 screw	0.98	1.18	1.47	
M _s		Mounting to heat sink M 6 screw	1.96	2.45	2.94	
m	Weight	-	-	480	-	g
e _c	Flatness of base plate	On the centerline X, Y (Note.5)	±0	-	+100	µm

ELECTRICAL CHARACTERISTICS (T_j=25 °C, unless otherwise specified)

Symbol	Item	Conditions	Limits			Unit	
			Min.	Typ.	Max.		
I _{CES}	Collector-emitter cut-off current	V _{GE} =V _{CES} , G-E short-circuited	-	-	1	mA	
I _{GES}	Gate-emitter leakage current	±V _{GE} =V _{GES} , C-E short-circuited	-	-	3	µA	
V _{GE(th)}	Gate-emitter threshold voltage	I _C =50 mA, V _{CE} =10 V	5.5	7	8.5	V	
V _{CEsat}	Collector-emitter saturation voltage	I _C =500 A (Note.6), V _{GE} =15 V	T _j =25 °C	-	2.2	3.0	V
			T _j =125 °C	-	2.45	-	
C _{ies}	Input capacitance	V _{CE} =10 V, G-E short-circuited	-	-	120	nF	
C _{oes}	Output capacitance		-	-	14		
C _{res}	Reverse transfer capacitance		-	-	2.6		
Q _G	Gate charge	V _{CC} =1000 V, I _C =500 A, V _{GE} =15 V	-	3300	-	nC	
t _{d(on)}	Turn-on delay time	V _{CC} =1000 V, I _C =500 A, V _{GE} =±15 V, R _G =3.0 Ω, Inductive load	-	-	900	ns	
t _r	Rise time		-	-	500		
t _{d(off)}	Turn-off delay time		-	-	700		
t _f	Fall time		-	-	350		
V _{EC} (Note.1)	Emitter-collector voltage	I _E =500 A (Note.6), G-E short-circuited	-	2.3	3.2	V	
t _{rr} (Note.1)	Reverse recovery time	V _{CC} =1000 V, I _E =500 A, V _{GE} =±15 V, R _G =3.0 Ω, Inductive load	-	-	650	ns	
Q _{rr} (Note.1)	Reverse recovery charge		-	50	-		µC
E _{on}	Turn-on switching energy per pulse	V _{CC} =1000 V, I _C =I _E =500 A, V _{GE} =±15 V, R _G =3.0 Ω, T _j =125 °C, Inductive load	-	267.8	-	mJ	
E _{off}	Turn-off switching energy per pulse		-	138.5	-		
E _{rr} (Note.1)	Reverse recovery energy per pulse		-	98.1	-		
r _g	Internal gate resistance	T _C =25 °C	-	1.0	-	Ω	
R _G	External gate resistance	-	3.0	-	10	Ω	

THERMAL RESISTANCE CHARACTERISTICS

Symbol	Item	Conditions	Limits			Unit
			Min.	Typ.	Max.	
R _{th(j-c)Q}	Thermal resistance (Note.2)	Junction to case, IGBT part	-	-	25	K/KW
R _{th(j-c)D}		Junction to case, FWDi part	-	-	42	
R _{th(c-s)}	Contact thermal resistance (Note.2)	Case to heat sink, Thermal grease applied (Note.7)	-	20	-	K/KW

Note.1: Represent ratings and characteristics of the anti-parallel, emitter-collector free wheeling diode (FWDi).
 Note.2: Case temperature (T_c) and heat sink temperature (T_s) are defined on the each surface of base plate and heat sink just under the chips. (Refer to the figure of chip location)

The heat sink thermal resistance $\{R_{th(s-a)}\}$ should measure just under the chips.

Note.3: Pulse width and repetition rate should be such that the device junction temperature (T_j) dose not exceed T_{jmax} rating.

Note.4: Junction temperature (T_j) should not increase beyond T_{jmax} rating.

Note.5: Base plate flatness measurement point is as in the following figure.

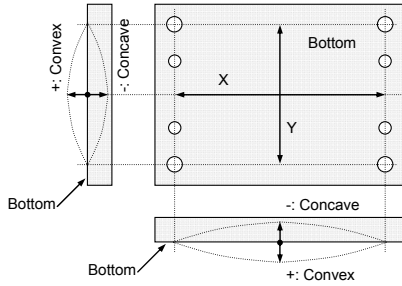

Note.6: Pulse width and repetition rate should be such as to cause negligible temperature rise. (Refer to the figure of test circuit)

Note.7: Typical value is measured by using thermally conductive grease of $\lambda=0.9$ W/(m·K).

CHIP LOCATION (Top view)

Dimension in mm, tolerance: ± 1 mm

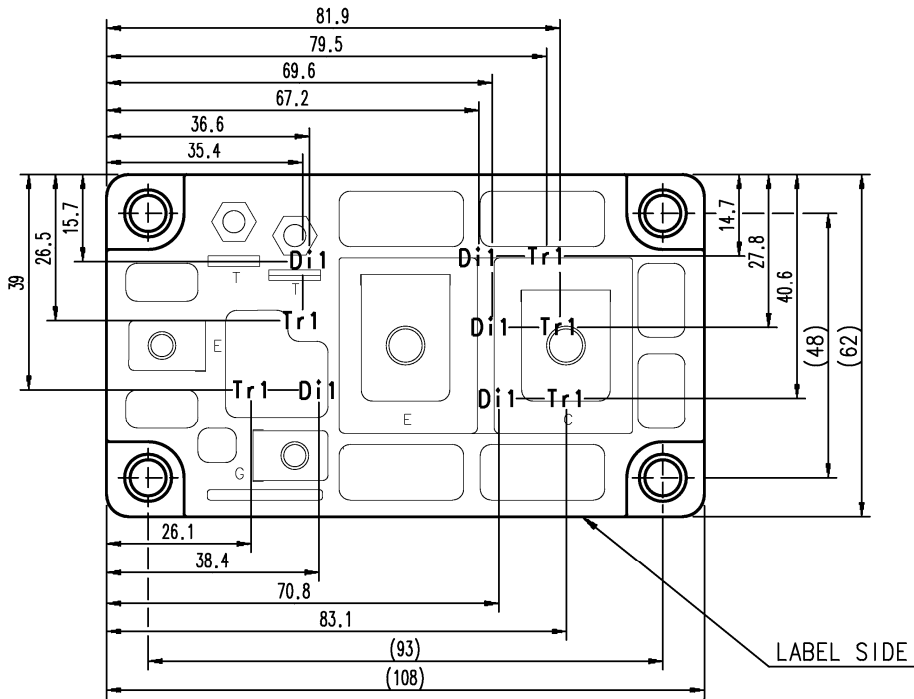

Tr1: IGBT, Di1: FWDi. Each mark points the center position of each chip.

TEST CIRCUIT AND WAVEFORMS

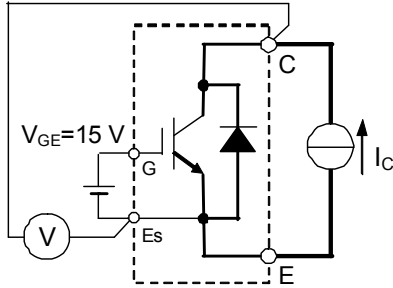

V_{CEsat} test circuit

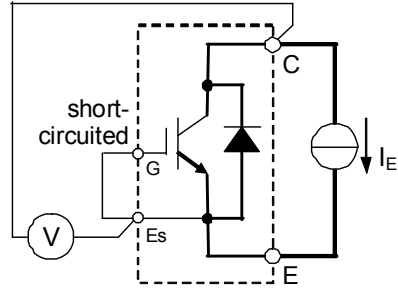

V_{EC} test circuit

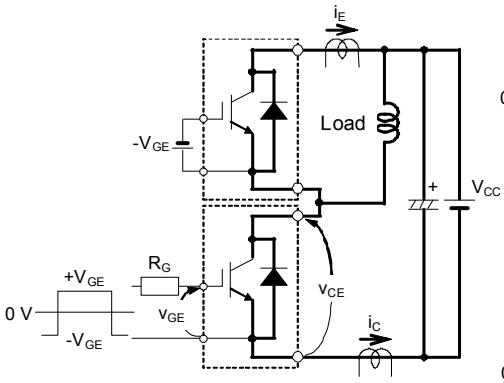

Switching characteristics test circuit and waveforms

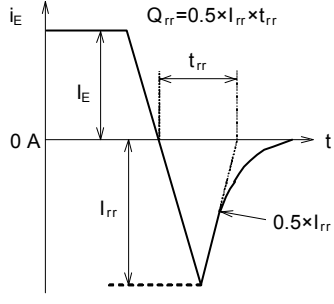
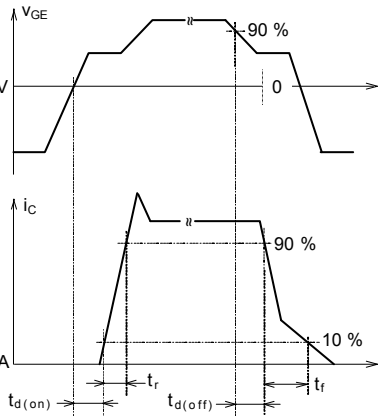

t_{rr} , Q_{rr} test waveform

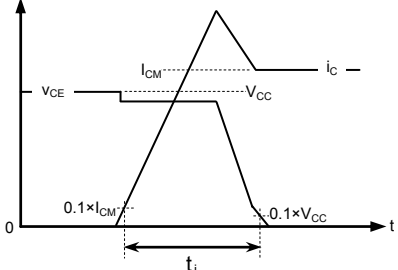

IGBT Turn-on switching energy

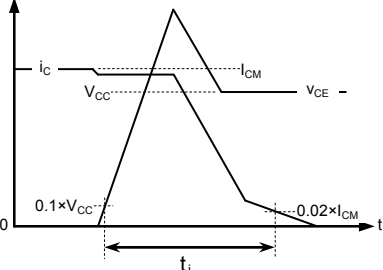

IGBT Turn-off switching energy

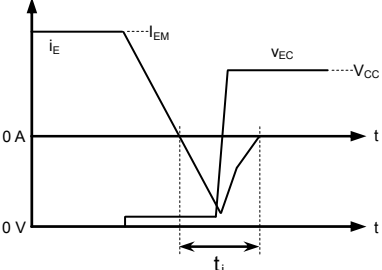

FWDi Reverse recovery energy

Turn-on, Turn-off switching and Reverse recovery energy test waveforms (integral range)

PERFORMANCE CURVES

OUTPUT CHARACTERISTICS
 (TYPICAL)

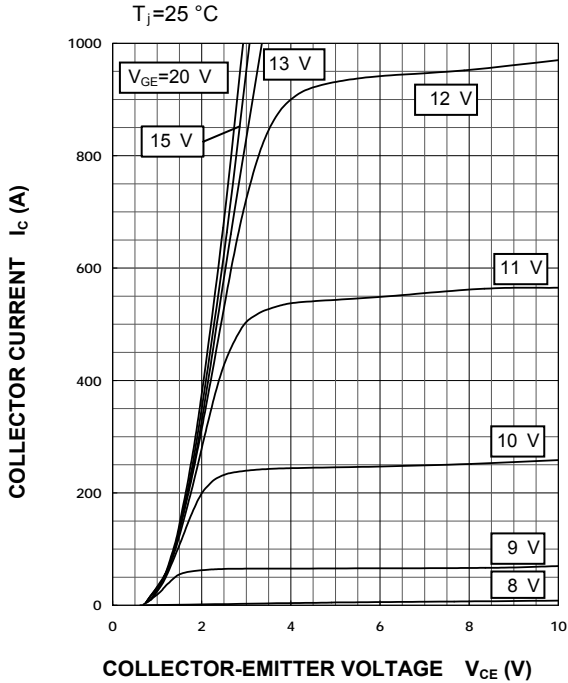

COLLECTOR-EMITTER SATURATION
 VOLTAGE CHARACTERISTICS
 (TYPICAL)

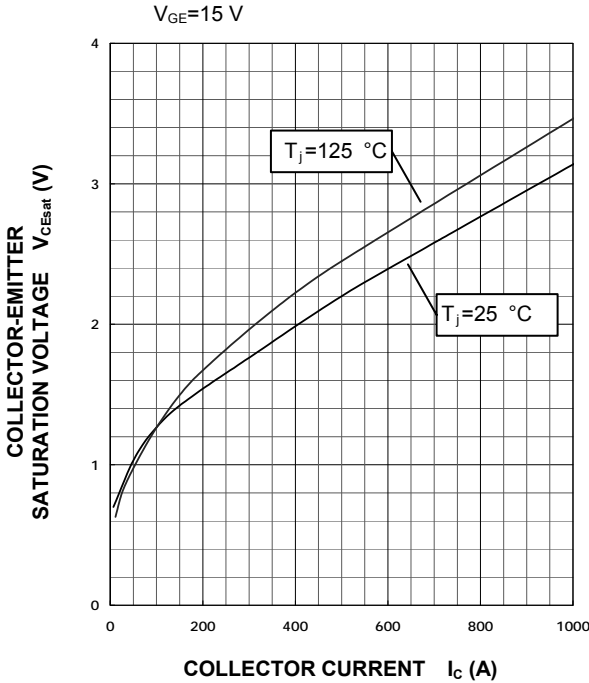

COLLECTOR-EMITTER SATURATION
 VOLTAGE CHARACTERISTICS
 (TYPICAL)

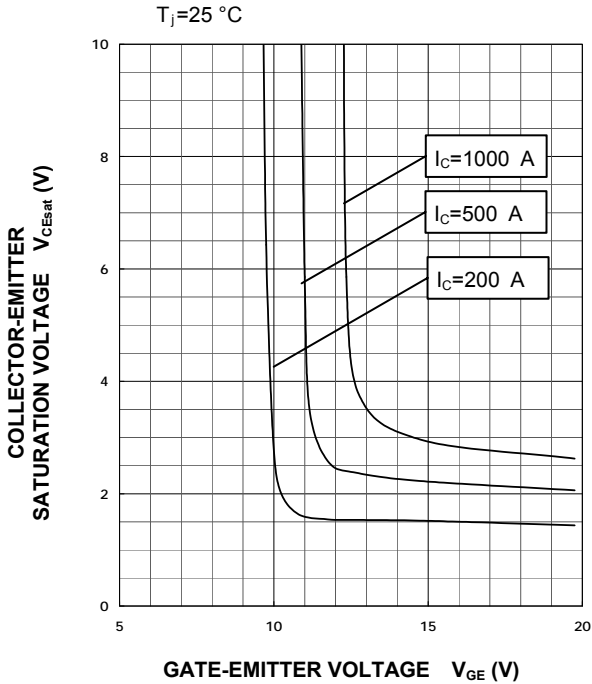

FREE WHEELING DIODE
 FORWARD CHARACTERISTICS
 (TYPICAL)

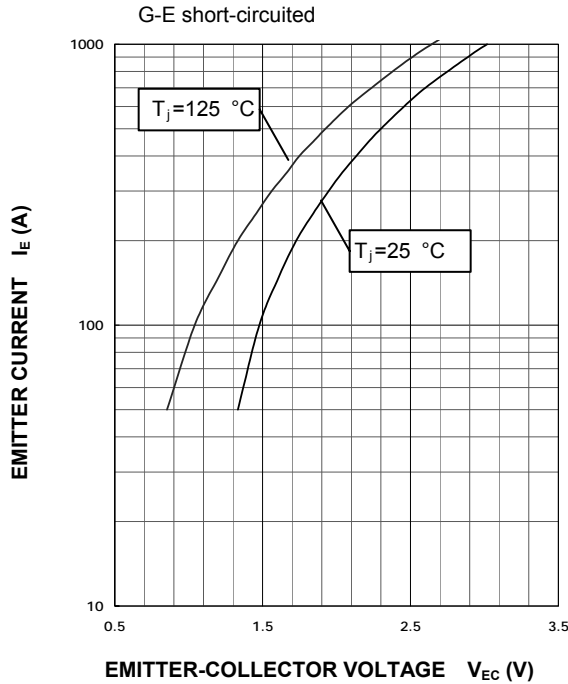

**HALF-BRIDGE
 SWITCHING CHARACTERISTICS
 (TYPICAL)**

$V_{CC}=1000\text{ V}$, $V_{GE}=\pm 15\text{ V}$, $R_G=3.0\ \Omega$, $T_j=125\text{ }^\circ\text{C}$
 INDUCTIVE LOAD

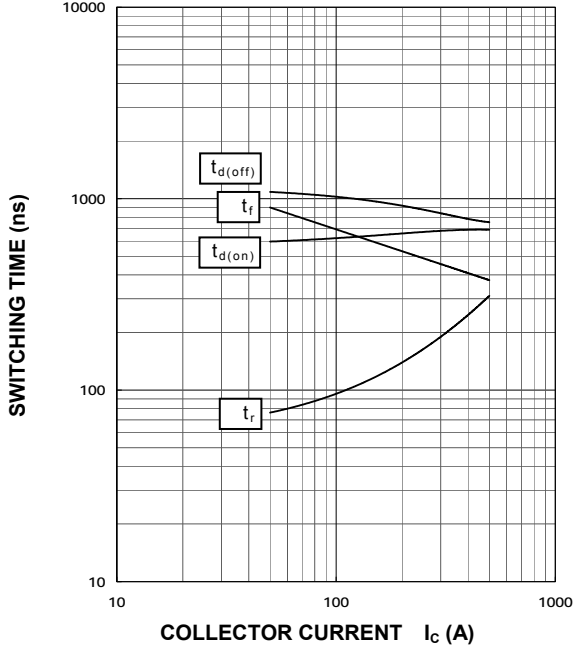

**HALF-BRIDGE
 SWITCHING CHARACTERISTICS
 (TYPICAL)**

$V_{CC}=1000\text{ V}$, $I_C=500\text{ A}$, $V_{GE}=\pm 15\text{ V}$, $T_j=125\text{ }^\circ\text{C}$
 INDUCTIVE LOAD

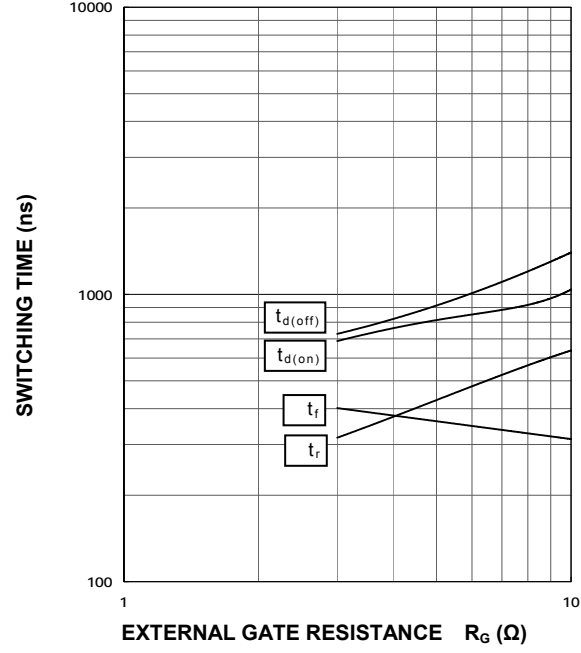

**HALF-BRIDGE
 SWITCHING CHARACTERISTICS
 (TYPICAL)**

$V_{CC}=1000\text{ V}$, $V_{GE}=\pm 15\text{ V}$, $R_G=3.0\ \Omega$, $T_j=125\text{ }^\circ\text{C}$
 INDUCTIVE LOAD, PER PULSE

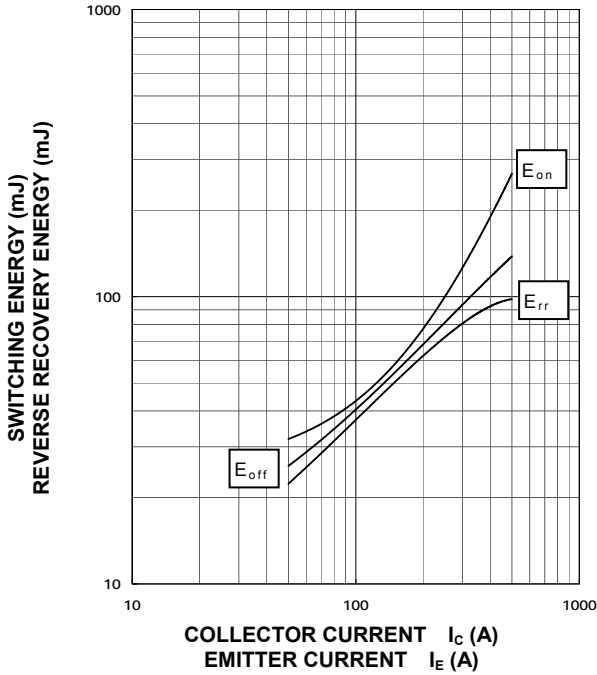

**HALF-BRIDGE
 SWITCHING CHARACTERISTICS
 (TYPICAL)**

$V_{CC}=1000\text{ V}$, $I_C/I_E=500\text{ A}$, $V_{GE}=\pm 15\text{ V}$, $T_j=125\text{ }^\circ\text{C}$
 INDUCTIVE LOAD, PER PULSE

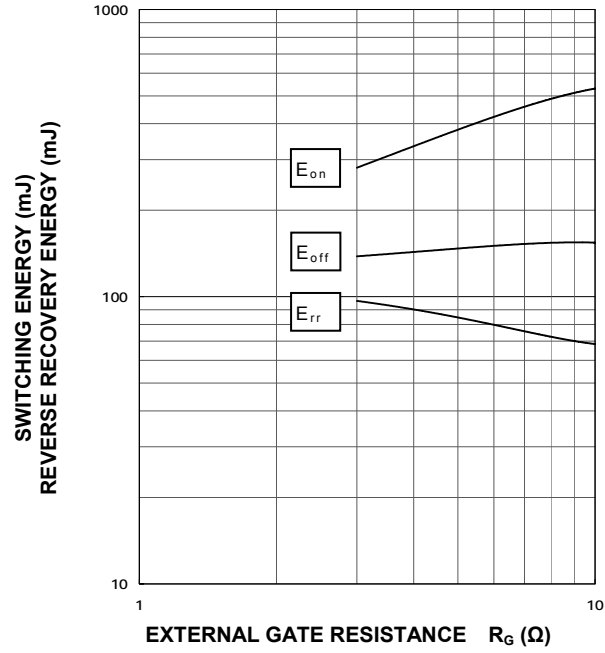

**CAPACITANCE CHARACTERISTICS
 (TYPICAL)**

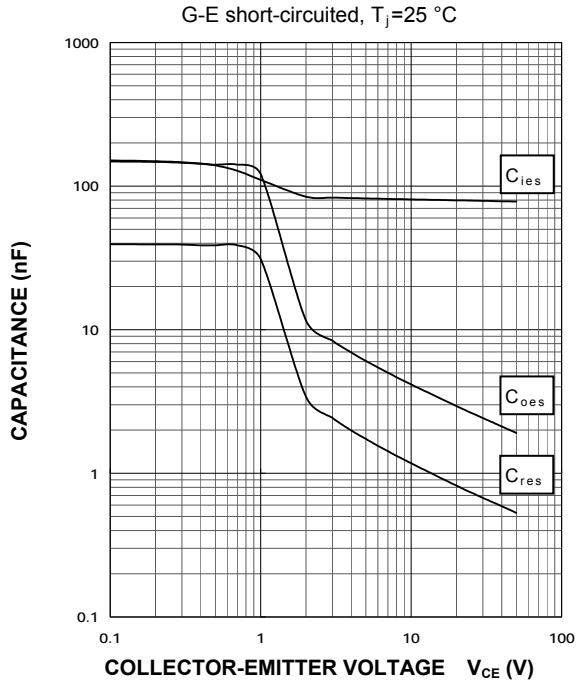

**GATE CHARGE CHARACTERISTICS
 (TYPICAL)**

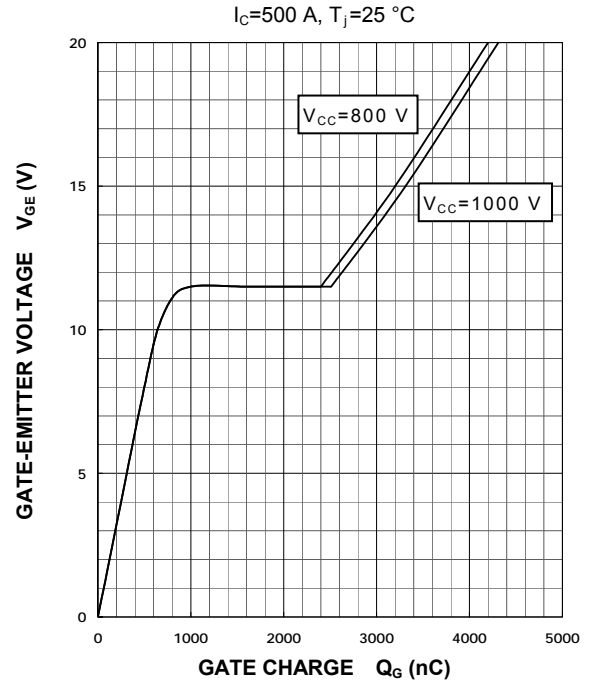

**FREE WHEELING DIODE
 REVERSE RECOVERY CHARACTERISTICS
 (TYPICAL)**
 $V_{CC}=1000\text{ V}$, $V_{GE}=\pm 15\text{ V}$, $R_G=3.0\text{ }\Omega$, $T_j=125\text{ }^\circ\text{C}$
 INDUCTIVE LOAD

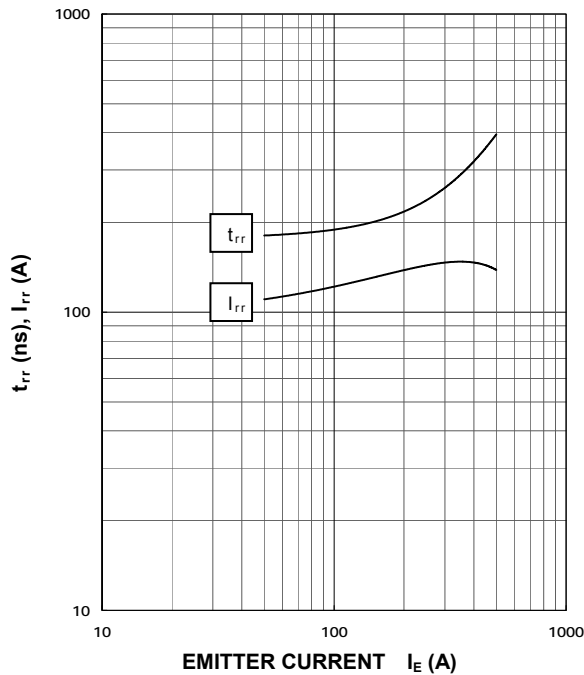

**TRANSIENT THERMAL IMPEDANCE
 CHARACTERISTICS
 (MAXIMUM)**

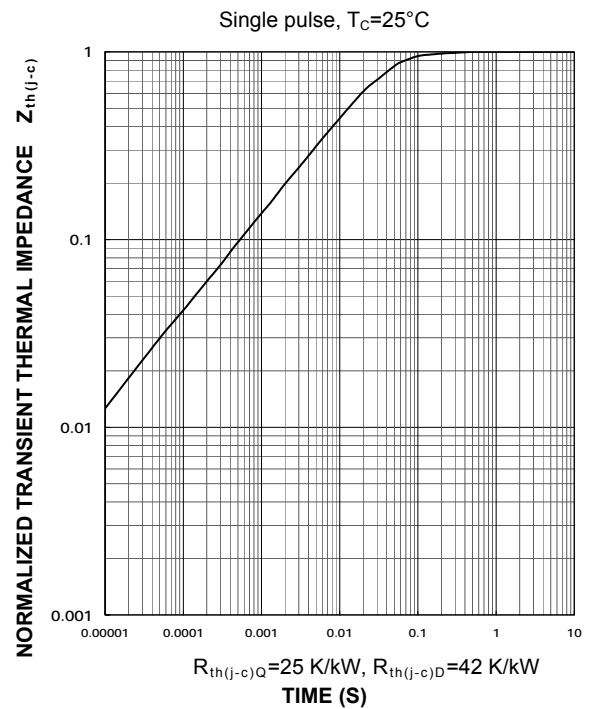

Keep safety first in your circuit designs!

·Mitsubishi Electric Corporation puts the maximum effort into making semiconductor products better and more reliable, but there is always the possibility that trouble may occur with them. Trouble with semiconductors may lead to personal injury, fire or property damage.

Remember to give due consideration to safety when making your circuit designs, with appropriate measures such as (i) placement of substitutive, auxiliary circuits, (ii) use of non-flammable material or (iii) prevention against any malfunction or mishap.

Notes regarding these materials

·These materials are intended as a reference to assist our customers in the selection of the Mitsubishi semiconductor product best suited to the customer's application; they do not convey any license under any intellectual property rights, or any other rights, belonging to Mitsubishi Electric Corporation or a third party.

·Mitsubishi Electric Corporation assumes no responsibility for any damage, or infringement of any third-party's rights, originating in the use of any product data, diagrams, charts, programs, algorithms, or circuit application examples contained in these materials.

·All information contained in these materials, including product data, diagrams, charts, programs and algorithms represents information on products at the time of publication of these materials, and are subject to change by Mitsubishi Electric Corporation without notice due to product improvements or other reasons. It is therefore recommended that customers contact Mitsubishi Electric Corporation or an authorized Mitsubishi Semiconductor product distributor for the latest product information before purchasing a product listed herein. The information described here may contain technical inaccuracies or typographical errors. Mitsubishi Electric Corporation assumes no responsibility for any damage, liability, or other loss rising from these inaccuracies or errors.

Please also pay attention to information published by Mitsubishi Electric Corporation by various means, including the Mitsubishi Semiconductor home page (<http://www.mitsubishichips.com/Global/index.html>).

·When using any or all of the information contained in these materials, including product data, diagrams, charts, programs, and algorithms, please be sure to evaluate all information as a total system before making a final decision on the applicability of the information and products. Mitsubishi Electric Corporation assumes no responsibility for any damage, liability or other loss resulting from the information contained herein.

·Mitsubishi Electric Corporation semiconductors are not designed or manufactured for use in a device or system that is used under circumstances in which human life is potentially at stake. Please contact Mitsubishi Electric Corporation or an authorized Mitsubishi Semiconductor product distributor when considering the use of a product contained herein for any specific purposes, such as apparatus or systems for transportation, vehicular, medical, aerospace, nuclear, or undersea repeater use.

·The prior written approval of Mitsubishi Electric Corporation is necessary to reprint or reproduce in whole or in part these materials.

·If these products or technologies are subject to the Japanese export control restrictions, they must be exported under a license from the Japanese government and cannot be imported into a country other than the approved destination.

Any diversion or reexport contrary to the export control laws and regulations of Japan and/or the country of destination is prohibited.

·Please contact Mitsubishi Electric Corporation or an authorized Mitsubishi Semiconductor product distributor for further details on these materials or the products contained therein.