

SRDA05-4R2

Advance Information

Low Capacitance Surface Mount TVS for High-Speed Data Interfaces

The SRDA05-4 transient voltage suppressor is designed to protect equipment attached to high speed communication lines from ESD, EFT, and lightning.

Features:

- SO-8 Package
- Peak Power – 500 Watts 8 x 20 μ S
- ESD Rating:
 - IEC 61000-4-2 (ESD) 15 kV (air) 8 kV (contact)
 - IEC 61000-4-4 (EFT) 40 A (5/50 ns)
 - IEC 61000-4-5 (lighting) 23 (8/20 μ s)
- UL Flammability Rating of 94V-0

Typical Applications:

- High Speed Communication Line Protection

MAXIMUM RATINGS

Rating	Symbol	Value	Unit
Peak Power Dissipation 8 x 20 μ S @ T _A = 25°C (Note 1)	P _{pk}	500	W
Junction and Storage Temperature Range	T _J , T _{stg}	-55 to +150	°C
Lead Solder Temperature – Maximum 10 Seconds Duration	T _L	260	°C

1. Non-repetitive current pulse 8 x 20 μ S exponential decay waveform

This document contains information on a new product. Specifications and information herein are subject to change without notice.



ON Semiconductor®

<http://onsemi.com>

SO-8 LOW CAPACITANCE VOLTAGE SUPPRESSOR 500 WATTS PEAK POWER 6 VOLTS

PIN CONFIGURATION AND SCHEMATIC

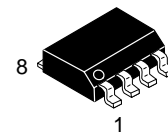
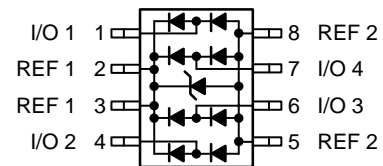

SO-8
CASE 751
PLASTIC

MARKING DIAGRAM

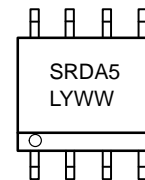

SRDA5= Device Code
L = Location Code
Y = Year
WW = Work Week

ORDERING INFORMATION

Device	Package	Shipping
SRDA05-4R2	SO-8	2500/Tape & Reel

ELECTRICAL CHARACTERISTICS

Characteristic	Symbol	Min	Typ	Max	Unit
Reverse Breakdown Voltage @ $I_T = 1.0 \text{ mA}$	V_{BR}	6.0	-	-	V
Reverse Leakage Current @ $V_{RWM} = 5.0 \text{ Volts}$	I_R	N/A	-	10	μA
Maximum Clamping Voltage @ $I_{PP} = 1.0 \text{ A}, 8 \times 20 \mu\text{S}$	V_C	N/A	-	9.8	V
Maximum Clamping Voltage @ $I_{PP} = 10 \text{ A}, 8 \times 20 \mu\text{S}$	V_C	N/A	-	12	V
Between I/O Pins and Ground @ $V_R = 0 \text{ Volts}, 1.0 \text{ MHz}$	Capacitance	-	-	15	pF
Between I/O Pins @ $V_R = 0 \text{ Volts}, 1.0 \text{ MHz}$	Capacitance	-	-	-	pF

ELECTRICAL CHARACTERISTICS

($T_A = 25^\circ\text{C}$ unless otherwise noted)

UNIDIRECTIONAL (Circuit tied to Pins 1 and 3 or 2 and 3)

Symbol	Parameter
I_{PP}	Maximum Reverse Peak Pulse Current
V_C	Clamping Voltage @ I_{PP}
V_{RWM}	Working Peak Reverse Voltage
I_R	Maximum Reverse Leakage Current @ V_{RWM}
V_{BR}	Breakdown Voltage @ I_T
I_T	Test Current
ΘV_{BR}	Maximum Temperature Coefficient of V_{BR}
I_F	Forward Current
V_F	Forward Voltage @ I_F
Z_{ZT}	Maximum Zener Impedance @ I_{ZT}
I_{ZK}	Reverse Current
Z_{ZK}	Maximum Zener Impedance @ I_{ZK}

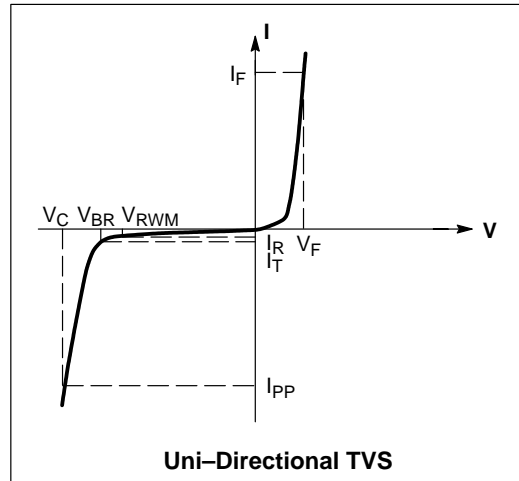

TYPICAL CHARACTERISTICS

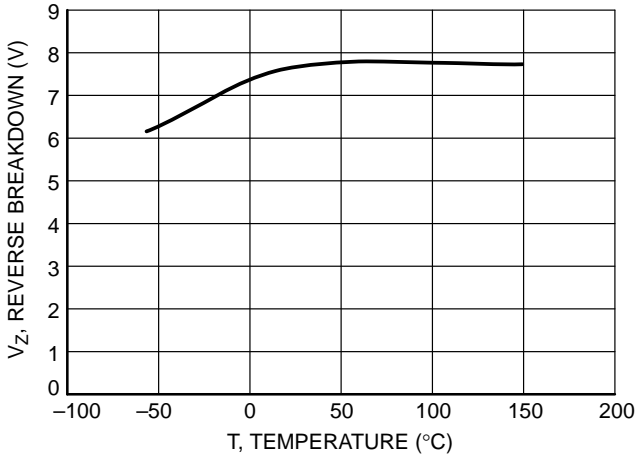

Figure 1. Reverse Breakdown versus Temperature

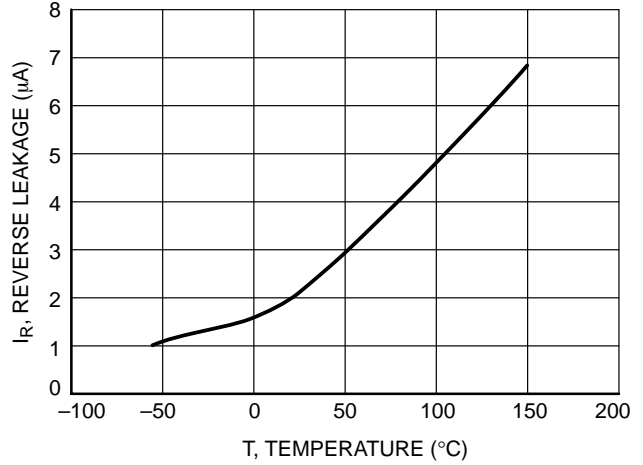

Figure 2. Reverse Leakage versus Temperature

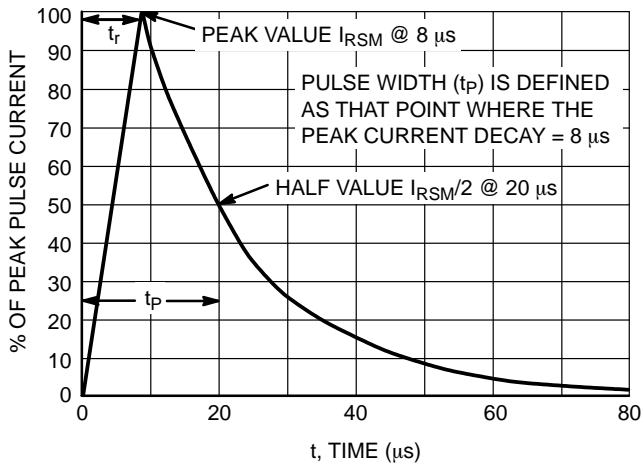

Figure 3. 8 × 20 µs Pulse Waveform

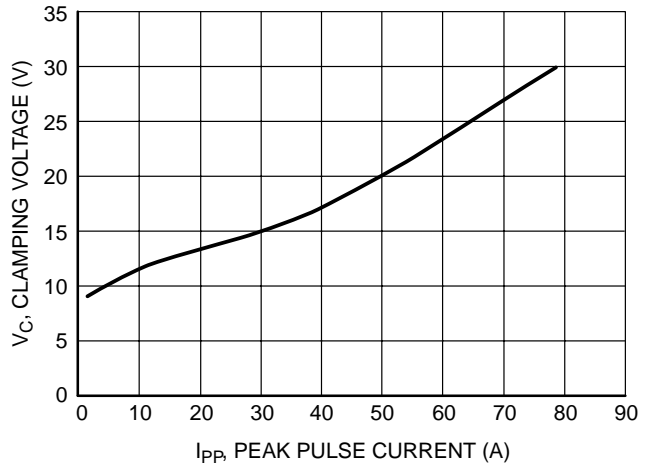
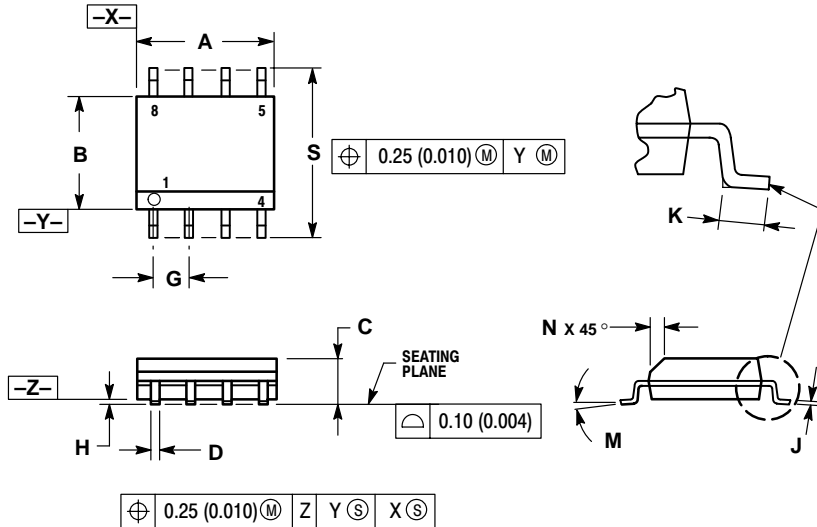

Figure 4. Clamping Voltage versus Peak Pulse Current

Transient Voltage Suppressor – Surface Mount

500 Watts Peak Power

SO-8
CASE 751-07
ISSUE W



- NOTES:
1. DIMENSIONING AND TOLERANCING PER ANSI Y14.5M, 1982.
 2. CONTROLLING DIMENSION: MILLIMETER.
 3. DIMENSION A AND B DO NOT INCLUDE MOLD PROTRUSION.
 4. MAXIMUM MOLD PROTRUSION 0.15 (0.006) PER SIDE.
 5. DIMENSION D DOES NOT INCLUDE DAMBAR PROTRUSION. ALLOWABLE DAMBAR PROTRUSION SHALL BE 0.127 (0.005) TOTAL IN EXCESS OF THE D DIMENSION AT MAXIMUM MATERIAL CONDITION.

DIM	MILLIMETERS		INCHES	
	MIN	MAX	MIN	MAX
A	4.80	5.00	0.189	0.197
B	3.80	4.00	0.150	0.157
C	1.35	1.75	0.053	0.069
D	0.33	0.51	0.013	0.020
G	1.27 BSC		0.050 BSC	
H	0.10	0.25	0.004	0.010
J	0.19	0.25	0.007	0.010
K	0.40	1.27	0.016	0.050
M	0°	8°	0°	8°
N	0.25	0.50	0.010	0.020
S	5.80	6.20	0.228	0.244

ON Semiconductor is a trademark and  is a registered trademark of Semiconductor Components Industries, LLC (SCILLC). SCILLC reserves the right to make changes without further notice to any products herein. SCILLC makes no warranty, representation or guarantee regarding the suitability of its products for any particular purpose, nor does SCILLC assume any liability arising out of the application or use of any product or circuit, and specifically disclaims any and all liability, including without limitation special, consequential or incidental damages. "Typical" parameters which may be provided in SCILLC data sheets and/or specifications can and do vary in different applications and actual performance may vary over time. All operating parameters, including "Typicals" must be validated for each customer application by customer's technical experts. SCILLC does not convey any license under its patent rights nor the rights of others. SCILLC products are not designed, intended, or authorized for use as components in systems intended for surgical implant into the body, or other applications intended to support or sustain life, or for any other application in which the failure of the SCILLC product could create a situation where personal injury or death may occur. Should Buyer purchase or use SCILLC products for any such unintended or unauthorized application, Buyer shall indemnify and hold SCILLC and its officers, employees, subsidiaries, affiliates, and distributors harmless against all claims, costs, damages, and expenses, and reasonable attorney fees arising out of, directly or indirectly, any claim of personal injury or death associated with such unintended or unauthorized use, even if such claim alleges that SCILLC was negligent regarding the design or manufacture of the part. SCILLC is an Equal Opportunity/Affirmative Action Employer.

PUBLICATION ORDERING INFORMATION

Literature Fulfillment:

Literature Distribution Center for ON Semiconductor
P.O. Box 5163, Denver, Colorado 80217 USA
Phone: 303-675-2175 or 800-344-3860 Toll Free USA/Canada
Fax: 303-675-2176 or 800-344-3867 Toll Free USA/Canada
Email: ONlit@hibbertco.com

N. American Technical Support: 800-282-9855 Toll Free USA/Canada

JAPAN: ON Semiconductor, Japan Customer Focus Center
4-32-1 Nishi-Gotanda, Shinagawa-ku, Tokyo, Japan 141-0031
Phone: 81-3-5740-2700
Email: r14525@onsemi.com

ON Semiconductor Website: <http://onsemi.com>

For additional information, please contact your local Sales Representative.