

RoHS Compliant Product

A suffix of "-C" specifies halogen & lead-free

FEATURES

Power dissipation

$P_{CM} : 1 \text{ W}$

Collector Current

$I_{CM} : -1.5 \text{ A}$

Collector-base voltage

$V_{(BR)CBO} : -40 \text{ V}$

Operating & storage junction temperature

$T_j, T_{stg} : -55^{\circ}\text{C} \sim +150^{\circ}\text{C}$

TO-92

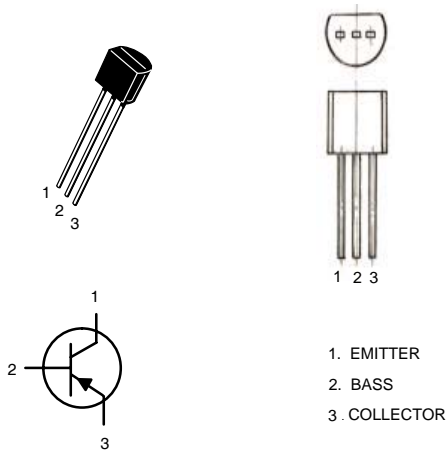

ELECTRICAL CHARACTERISTICS ($T_{amp}=25^{\circ}\text{C}$ unless otherwise specified)

Parameter	Symbol	Test conditions	MIN	TYP	MAX	UNIT
Collector-base breakdown voltage	$V_{(BR)CBO}$	$I_C = -100 \mu\text{A}, I_E = 0$	-40			V
Collector-emitter breakdown voltage	$V_{(BR)CEO}$	$I_C = -0.1\text{mA}, I_B = 0$	-25			V
Emitter-base breakdown voltage	$V_{(BR)EBO}$	$I_E = -100 \mu\text{A}, I_C = 0$	-5			V
Collector cut-off current	I_{CBO}	$V_{CB} = -40 \text{ V}, I_E = 0$			-0.1	μA
Collector cut-off current	I_{CEO}	$V_{CE} = -20\text{V}, I_B = 0$			-0.1	μA
Emitter cut-off current	I_{EBO}	$V_{EB} = -5\text{V}, I_C = 0$			-0.1	μA
DC current gain	$H_{FE(1)}$	$V_{CE} = -1\text{V}, I_C = -100\text{mA}$	85		400	
	$H_{FE(2)}$	$V_{CE} = -1\text{V}, I_C = -800\text{mA}$	40			
Collector-emitter saturation voltage	$V_{CE(sat)}$	$I_C = -800 \text{ mA}, I_B = -80\text{mA}$			-0.5	V
Base-emitter saturation voltage	$V_{BE(sat)}$	$I_C = -800 \text{ mA}, I_B = -80\text{mA}$			-1.2	V
Transition frequency	f_T	$V_{CE} = -10\text{V}, I_C = -50\text{mA}$ $f = 30\text{MHz}$	100			MHz

CLASSIFICATION OF $h_{FE(1)}$

Rank	B	C	D	E
Range	85-160	120-200	160-300	300-400

Typical Characteristics

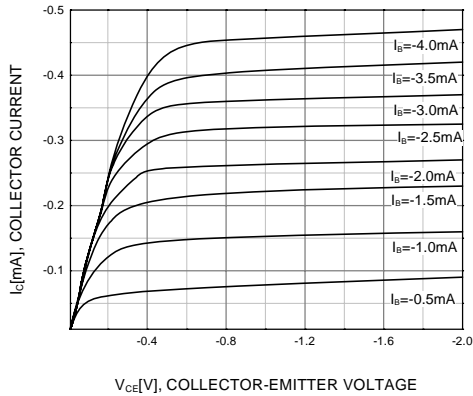

Figure 1. Static Characteristic

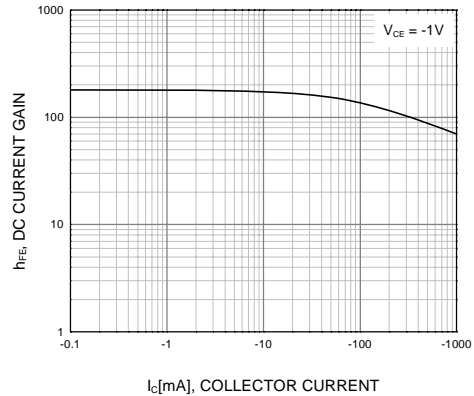
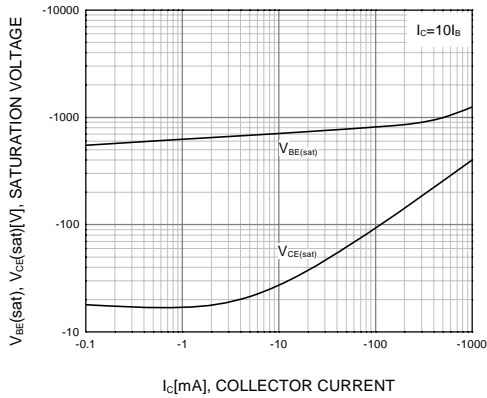

Figure 2. DC current Gain



**Figure 3. Base-Emitter Saturation Voltage
Collector-Emitter Saturation Voltage**

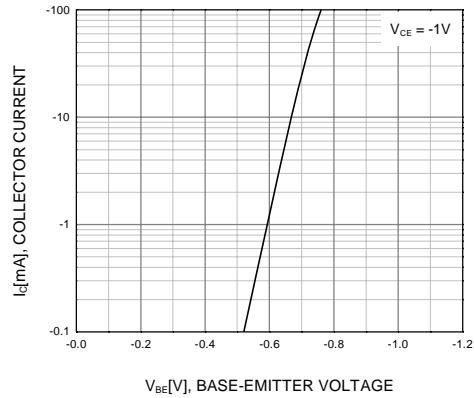

Figure 4. Base-Emitter On Voltage

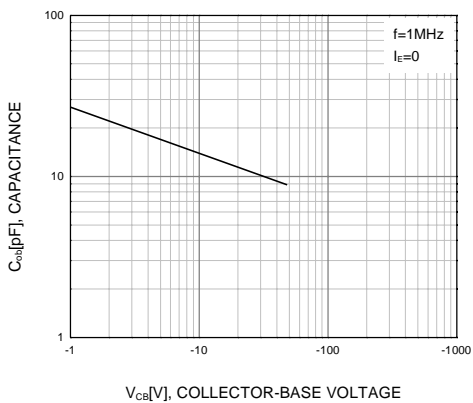

Figure 5. Collector Output Capacitance

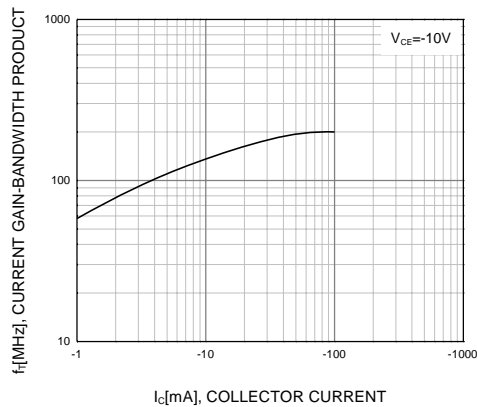

Figure 6. Current Gain Bandwidth Product