

# TMS27C256 262144-BIT UV ERASABLE PROGRAMMABLE TMS27PC256 262144-BIT PROGRAMMABLE READ-ONLY MEMORY

SMLS256G - SEPTEMBER 1984 - REVISED JUNE 1995

*This Data Sheet is Applicable to All  
TMS27C256s and TMS27PC256s Symbolized  
With Code "B" as Described on Page 157.*

- Organization . . . 32K × 8
  - Single 5-V Power Supply
  - Pin Compatible With Existing 256K MOS ROMs, PROMs, and EPROMs
  - All Inputs /Outputs Fully TTL Compatible
  - Max Access/Min Cycle Time
- V<sub>CC</sub> ± 10%**
- |               |        |
|---------------|--------|
| '27C/PC256-10 | 100 ns |
| '27C/PC256-12 | 120 ns |
| '27C/PC256-15 | 150 ns |
| '27C/PC256-17 | 170 ns |
| '27C/PC256-20 | 200 ns |
| '27C/PC256-25 | 250 ns |
- Power Saving CMOS Technology
  - Very High-Speed SNAP! Pulse Programming
  - 3-State Output Buffers
  - 400-mV Minimum DC Noise Immunity With Standard TTL Loads
  - Latchup Immunity of 250 mA on All Input and Output Lines
  - Low Power Dissipation (V<sub>CC</sub> = 5.5 V)
    - Active . . . 165 mW Worst Case
    - Standby . . . 1.4 mW Worst Case (CMOS Input Levels)
  - PEP4 Version Available With 168-Hour Burn-In, and Choices of Operating Temperature Ranges
  - 256K EPROM Available With MIL-STD-883C Class B High Reliability Processing (SMJ27C256)

### description

The TMS27C256 series are 262144-bit, ultra-violet-light erasable, electrically programmable read-only memories.

The TMS27PC256 series are 262144-bit, one-time electrically programmable read-only memories.

**J AND N PACKAGES  
(TOP VIEW)**

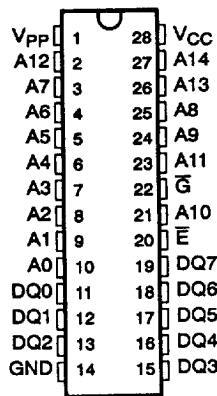

**FM PACKAGE  
(TOP VIEW)**

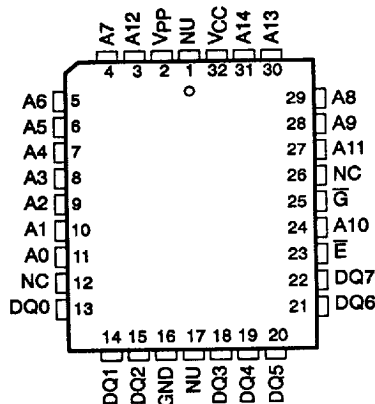

**PIN NOMENCLATURE**

A0-A14	Address Inputs
DQ0-DQ7	Inputs (programming)/Outputs
E	Chip Enable/Powerdown
G-bar	Output Enable
GND	Ground
NC	No Internal Connection
NU	Make No External Connection
VCC	5-V Power Supply
VPP	13-V Power Supply

PRODUCTION DATA Information is current as of publication date. Products conform to specifications per the terms of Texas Instruments standard warranty. Production processing does not necessarily include testing of all parameters.



POST OFFICE BOX 1443 • HOUSTON, TEXAS 77251-1443

Copyright © 1995, Texas Instruments Incorporated

7-143

8961725 0085636 036

**TMS27C256 262144-BIT UV ERASABLE PROGRAMMABLE  
TMS27PC256 262144-BIT PROGRAMMABLE  
READ-ONLY MEMORY**

SMLS256G - SEPTEMBER 1984 - REVISED JUNE 1995

**description (continued)**

These devices are fabricated using power-saving CMOS technology for high speed and simple interface with MOS and bipolar circuits. All inputs (including program data inputs) can be driven by Series 74 TTL circuits without the use of external pull-up resistors. Each output can drive one Series 74 TTL circuit without external resistors.

The data outputs are three-state for connecting multiple devices to a common bus. The TMS27C256 and the TMS27PC256 are pin compatible with 28-pin 256K MOS ROMs, PROMs, and EPROMs.

The TMS27C256 EPROM is offered in a dual-in-line ceramic package (J suffix) designed for insertion in mounting-hole rows on 15.2-mm (600-mil) centers. The TMS27PC256 OTP PROM is offered in a dual-in-line plastic package (N suffix) designed for insertion in mounting-hole rows on 15.2-mm (600-mil) centers. The TMS27PC256 OTP PROM is also supplied in a 32-lead plastic leaded chip-carrier package using 1,25-mm (50-mil) lead spacing (FM suffix).

The TMS27C256 and TMS27PC256 are offered with two choices of temperature ranges of 0°C to 70°C (JL, NL, and FML suffixes) and -40°C to 85°C (JE, NE, and FME suffixes). The TMS27C256 and the TMS27PC256 are also offered with 168-hour burn-in on both temperature ranges (JL4, FML4, JE4, and FME4 suffixes); see table below.

All package styles conform to JEDEC standards.

EPROM AND OTP PROM	SUFFIX FOR OPERATING TEMPERATURE RANGES WITHOUT PEP4 BURN-IN		SUFFIX FOR PEP4 168-HR. BURN-IN VS TEMPERATURE RANGES	
	0°C TO 70°C	-40°C TO 85°C	0°C TO 70°C	-40°C TO 85°C
TMS27C256-XXX	JL	JE	JL4	JE4
TMS27PC256-XXX	NL	NE	NL4	NE4
TMS27PC256-XXX	FML	FME	FML4	FME4

These EPROMs and OTP PROMs operate from a single 5-V supply (in the read mode), thus are ideal for use in microprocessor-based systems. One other 13-V supply is needed for programming. All programming signals are TTL level. These devices are programmable by the SNAP I Pulse programming algorithm. The SNAP I Pulse programming algorithm uses a  $V_{PP}$  of 13 V and a  $V_{CC}$  of 6.5 V for a nominal programming time of four seconds. For programming outside the system, existing EPROM programmers can be used. Locations can be programmed singly, in blocks, or at random.



POST OFFICE BOX 1443 • HOUSTON, TEXAS 77251-1443

7-144

8961725 0085637 T72

**TMS27C256 262 144-BIT UV ERASABLE PROGRAMMABLE  
TMS27PC256 262 144-BIT PROGRAMMABLE  
READ-ONLY MEMORY**

SMLS256G – SEPTEMBER 1984 – REVISED JUNE 1985

**operation**

The seven modes of operation are listed in the following table. The read mode requires a single 5-V supply. All inputs are TTL level except for  $V_{PP}$  during programming (13 V for SNAP! Pulse), and 12 V on A9 for the signature mode.

FUNCTION	MODE†							
	READ	OUTPUT DISABLE	STANDBY	PROGRAMMING	VERIFY	PROGRAM INHIBIT	SIGNATURE MODE	
$\bar{E}$	$V_{IL}$	$V_{IL}$	$V_{IH}$	$V_{IL}$	$V_{IH}$	$V_{IH}$	$V_{IL}$	
$\bar{G}$	$V_{IL}$	$V_{IH}$	X	$V_{IH}$	$V_{IL}$	X	$V_{IL}$	
$V_{PP}$	$V_{CC}$	$V_{CC}$	$V_{CC}$	$V_{PP}$	$V_{PP}$	$V_{PP}$	$V_{CC}$	
$V_{CC}$	$V_{CC}$	$V_{CC}$	$V_{CC}$	$V_{CC}$	$V_{CC}$	$V_{CC}$	$V_{CC}$	
A9	X	X	X	X	X	X	$V_{H}‡$ $V_{H}‡$	
A0	X	X	X	X	X	X	$V_{IL}$ $V_{IH}$	
DQ0–DQ7	Data Out	Hi-Z	Hi-Z	Data In	Data Out	Hi-Z	CODE	
							MFG	DEVICE
							97	04

† X can be  $V_{IL}$  or  $V_{IH}$ .

‡  $V_{H} = 12 V \pm 0.5 V$ .

**read/output disable**

When the outputs of two or more TMS27C256s or TMS27PC256s are connected in parallel on the same bus, the output of any particular device in the circuit can be read with no interference from the competing outputs of the other devices. To read the output of a single device, a low-level signal is applied to the  $\bar{E}$  and  $\bar{G}$  pins. All other devices in the circuit should have their outputs disabled by applying a high-level signal to one of these pins. Output data is accessed at pins DQ0 through DQ7.

**latchup immunity**

Latchup immunity on the TMS27C256 and TMS27PC256 is a minimum of 250 mA on all inputs and outputs. This feature provides latchup immunity beyond any potential transients at the P.C. board level when the devices are interfaced to industry-standard TTL or MOS logic devices. Input-output layout approach controls latchup without compromising performance or packing density.

**power down**

Active  $I_{CC}$  supply current can be reduced from 30 mA to 500  $\mu A$  (TTL-level inputs) or 250  $\mu A$  (CMOS-level inputs) by applying a high TTL or CMOS signal to the  $\bar{E}$  pin. In this mode all outputs are in the high-impedance state.

**erasure (TMS27C256)**

Before programming, the TMS27C256 EPROM is erased by exposing the chip through the transparent lid to a high intensity ultraviolet light (wavelength 2537 Å). EPROM erasure before programming is necessary to assure that all bits are in the logic high state. Logic lows are programmed into the desired locations. A programmed logic low can be erased only by ultraviolet light. The recommended minimum exposure dose (UV intensity  $\times$  exposure time) is 15-W $\cdot$ s/cm<sup>2</sup>. A typical 12-mW/cm<sup>2</sup>, filterless UV lamp erases the device in 21 minutes. The lamp should be located about 2.5 cm above the chip during erasure. It should be noted that normal ambient light contains the correct wavelength for erasure. Therefore, when using the TMS27C256, the window should be covered with an opaque label.



POST OFFICE BOX 1443 • HOUSTON, TEXAS 77251-1443

8961725 0085638 909

7-145

**TMS27C256 262 144-BIT UV ERASABLE PROGRAMMABLE**  
**TMS27PC256 262 144-BIT PROGRAMMABLE**  
**READ-ONLY MEMORY**

SMLS256G - SEPTEMBER 1984 - REVISED JUNE 1995

**Initializing (TMS27PC256)**

The one-time programmable TMS27PC256 PROM is provided with all bits in the logic high state, then logic lows are programmed into the desired locations. Logic lows programmed into an OTP PROM cannot be erased.

**SNAPI Pulse programming**

The 256K EPROM and OTP PROM are programmed using the TI SNAPI Pulse programming algorithm illustrated by the flowchart in Figure 1, which programs in a nominal time of four seconds. Actual programming time varies as a function of the programmer used.

Data is presented in parallel (eight bits) on pins DQ0 to DQ7. Once addresses and data are stable,  $\bar{E}$  is pulsed.

The SNAPI Pulse programming algorithm uses initial pulses of 100 microseconds ( $\mu\text{s}$ ) followed by a byte verification to determine when the addressed byte has been successfully programmed. Up to 10 (ten) 100- $\mu\text{s}$  pulses per byte are provided before a failure is recognized.

The programming mode is achieved when  $V_{PP} = 13\text{ V}$ ,  $V_{CC} = 6.5\text{ V}$ ,  $\bar{G} = V_{IH}$ , and  $\bar{E} = V_{IL}$ . More than one device can be programmed when the devices are connected in parallel. Locations can be programmed in any order. When the SNAPI Pulse programming routine is complete, all bits are verified with  $V_{CC} = V_{PP} = 5\text{ V}$ .

**program inhibit**

Programming can be inhibited by maintaining a high level input on the  $\bar{E}$  pin.

**program verify**

Programmed bits can be verified with  $V_{PP} = 13\text{ V}$  when  $\bar{G} = V_{IL}$  and  $\bar{E} = V_{IH}$ .

**signature mode**

The signature mode provides access to a binary code identifying the manufacturer and type. This mode is activated when A9 is forced to  $12\text{ V} \pm 0.5\text{ V}$ . Two identifier bytes are accessed by A0; i.e.,  $A0 = V_{IL}$  accesses the manufacturer code, which is output on DQ0-DQ7;  $A0 = V_{IH}$  accesses the device code, which is output on DQ0-DQ7. All other addresses must be held at  $V_{IL}$ . The manufacturer code for these devices is 97, and the device code is 04.



POST OFFICE BOX 1443 • HOUSTON, TEXAS 77251-1443

7-146

8961725 0085639 845

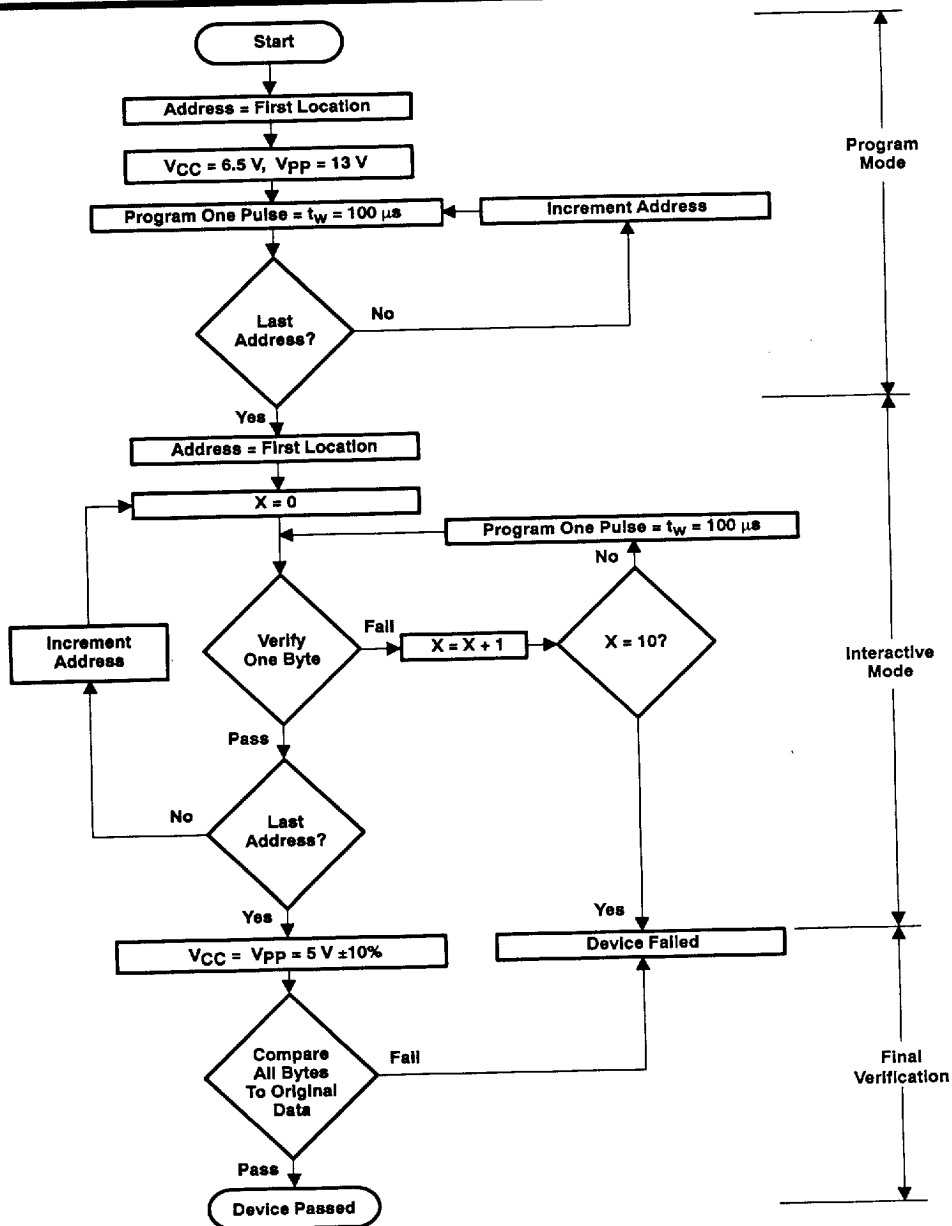

Figure 1. SNAPI Pulse Programming Flowchart



**TMS27C256 262144-BIT UV ERASABLE PROGRAMMABLE  
TMS27PC256 262144-BIT PROGRAMMABLE  
READ-ONLY MEMORY**

SMLS256G - SEPTEMBER 1984 - REVISED JUNE 1995

**logic symbol†**

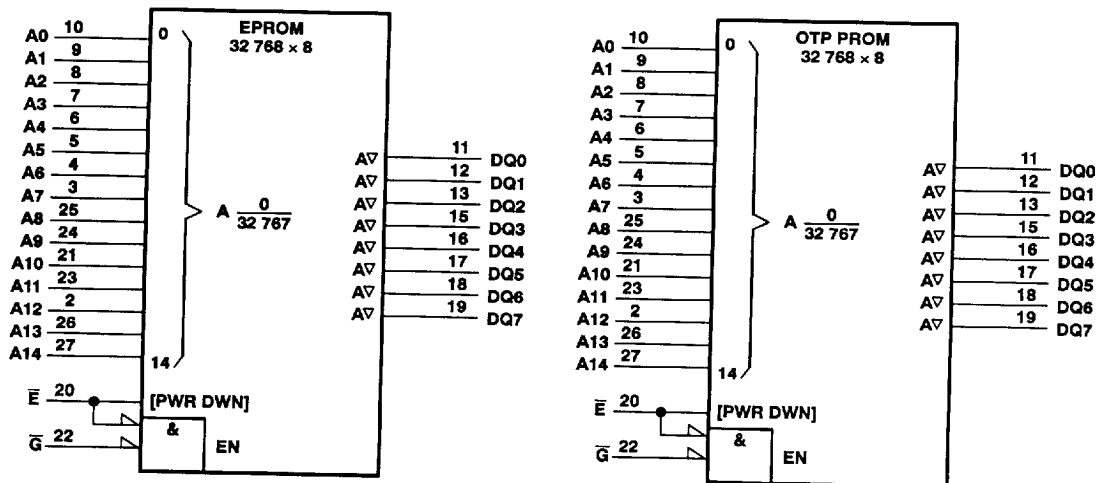

† These symbols are in accordance with ANSI/IEEE Std 91-1984 and IEC Publication 617-12. Pin numbers shown are for J and N packages.

**absolute maximum ratings over operating free-air temperature range (unless otherwise noted)‡**

Supply voltage range, $V_{CC}$ (see Note 1)	-0.6 V to 7 V
Supply voltage range, $V_{pp}$	-0.6 V to 14 V
Input voltage range (see Note 1): All inputs except A9	-0.6 V to $V_{CC} + 1$ V
A9	-0.6 V to 13.5 V
Output voltage range (see Note 1)	-0.6 V to $V_{CC} + 1$ V
Operating free-air temperature range ('27C256-__JL and JL4, '27PC256-__NL, NL4, FML, and FML4)	0° C to 70° C
Operating free-air temperature range ('27C256-__JE and JE4, '27PC256-__NE, NE4, FME, and FME4)	-40° C to 85° C
Storage temperature range, $T_{stg}$	-65° C to 150° C

‡ Stresses beyond those listed under "absolute maximum ratings" may cause permanent damage to the device. These are stress ratings only, and functional operation of the device at these or any other conditions beyond those indicated under "recommended operating conditions" is not implied. Exposure to absolute-maximum-rated conditions for extended periods may affect device reliability.

NOTE 1: All voltage values are with respect to GND.



POST OFFICE BOX 1443 • HOUSTON, TEXAS 77251-1443

7-148

8961725 0085641 4T3

**TMS27C256 262 144-BIT UV ERASABLE PROGRAMMABLE  
TMS27PC256 262 144-BIT PROGRAMMABLE  
READ-ONLY MEMORY**

SMLS256G - SEPTEMBER 1984 - REVISED JUNE 1995

**recommended operating conditions**

		MIN	NOM	MAX	UNIT	
V <sub>CC</sub>	Supply voltage	Read mode (see Note 2)	4.5	5	5.5	V
		SNAPI Pulse programming algorithm	6.25	6.5	6.75	
V <sub>PP</sub>	Supply voltage	Read mode	V <sub>CC</sub> -0.6		V <sub>CC</sub> +0.6	V
		SNAPI Pulse programming algorithm	12.75	13	13.25	
V <sub>IH</sub>	High-level dc input voltage	TTL	2		V <sub>CC</sub> +1	V
		CMOS	V <sub>CC</sub> -0.2		V <sub>CC</sub> +1	
V <sub>IL</sub>	Low-level dc input voltage	TTL	-0.5		0.8	V
		CMOS	-0.5		0.2	
T <sub>A</sub>	Operating free-air temperature		0		70	°C
T <sub>A</sub>	Operating free-air temperature		-40		85	°C

NOTE 2: V<sub>CC</sub> must be applied before or at the same time as V<sub>PP</sub> and removed after or at the same time as V<sub>PP</sub>. The device must not be inserted into or removed from the board when V<sub>PP</sub> or V<sub>CC</sub> is applied.

**electrical characteristics over recommended ranges of operating conditions**

PARAMETER		TEST CONDITIONS	MIN	TYP†	MAX	UNIT	
V <sub>OH</sub>	High-level dc output voltage	I <sub>OH</sub> = -2.5 mA		3.5		V	
		I <sub>OH</sub> = -20 μA	V <sub>CC</sub> -0.1				
V <sub>OL</sub>	Low-level dc output voltage	I <sub>OL</sub> = 2.1 mA			0.4	V	
		I <sub>OL</sub> = 20 μA			0.1		
I <sub>I</sub>	Input current (leakage)	V <sub>I</sub> = 0 V to 5.5 V			±1	μA	
I <sub>O</sub>	Output current (leakage)	V <sub>O</sub> = 0 V to V <sub>CC</sub>			±1	μA	
I <sub>PP1</sub>	V <sub>PP</sub> supply current	V <sub>PP</sub> = V <sub>CC</sub> = 5.5 V			1	10	μA
I <sub>PP2</sub>	V <sub>PP</sub> supply current (during program pulse)	V <sub>PP</sub> = 13 V			35	50	mA
I <sub>CC1</sub>	V <sub>CC</sub> supply current (standby)	TTL-input level	V <sub>CC</sub> = 5.5 V,	$\bar{E} = V_{IH}$	250	500	μA
		CMOS-input level	V <sub>CC</sub> = 5.5 V,	$\bar{E} = V_{CC}$	100	250	
I <sub>CC2</sub>	V <sub>CC</sub> supply current (active)	V <sub>CC</sub> = 5.5 V, t <sub>cycle</sub> = minimum cycle time, outputs open			15	30	mA

**capacitance over recommended ranges of supply voltage and operating free-air temperature,  
f = 1 MHz‡**

PARAMETER		TEST CONDITIONS	MIN	TYP†	MAX	UNIT
C <sub>I</sub>	Input capacitance	V <sub>I</sub> = 0, f = 1 MHz		6	10	pF
C <sub>O</sub>	Output capacitance	V <sub>O</sub> = 0, f = 1 MHz		10	14	pF

† Typical values are at T<sub>A</sub> = 25°C and nominal voltages.

‡ Capacitance measurements are made on a sample basis only.



POST OFFICE BOX 1443 • HOUSTON, TEXAS 77251-1443

7-149

8961725 0085642 33T

**TMS27C256 262144-BIT UV ERASABLE PROGRAMMABLE  
TMS27PC256 262144-BIT PROGRAMMABLE  
READ-ONLY MEMORY**

SMLS256G - SEPTEMBER 1984 - REVISED JUNE 1995

**switching characteristics over recommended range of operating conditions**

PARAMETER	TEST CONDITIONS (SEE NOTES 3 AND 4)	'27C256-10 '27PC256-10		'27C256-12 '27PC256-12		'27C256-15 '27PC256-15		UNIT	
		MIN	MAX	MIN	MAX	MIN	MAX		
$t_{a(A)}$ Access time from address	$C_L = 100$ pF, 1 Series 74 TTL Load, Input $t_r \leq 20$ ns, Input $t_f \leq 20$ ns		100		120		150	ns	
$t_{a(E)}$ Access time from chip enable			100		120		150	ns	
$t_{en(G)}$ Output enable time from $\bar{G}$			55		55		75	ns	
$t_{dis}$ Output disable time from $\bar{G}$ or $\bar{E}$ , whichever occurs first†			0	45	0	45	0	60	ns
$t_{v(A)}$ Output data valid time after change of address, $\bar{E}$ , or $\bar{G}$ , whichever occurs first†			0		0		0		ns

PARAMETER	TEST CONDITIONS (SEE NOTES 3 AND 4)	'27C256-17 '27PC256-17		'27C256-20 '27PC256-20		'27C256-25 '27PC256-25		UNIT	
		MIN	MAX	MIN	MAX	MIN	MAX		
$t_{a(A)}$ Access time from address	$C_L = 100$ pF, 1 Series 74 TTL Load, Input $t_r \leq 20$ ns, Input $t_f \leq 20$ ns		170		200		250	ns	
$t_{a(E)}$ Access time from chip enable			170		200		250	ns	
$t_{en(G)}$ Output enable time from $\bar{G}$			75		75		100	ns	
$t_{dis}$ Output disable time from $\bar{G}$ or $\bar{E}$ , whichever occurs first†			0	60	0	60	0	60	ns
$t_{v(A)}$ Output data valid time after change of address, $\bar{E}$ , or $\bar{G}$ , whichever occurs first†			0		0		0		ns

† Value calculated from 0.5 V delta to measured level. This parameter is only sampled and not 100% tested.

**switching characteristics for programming:  $V_{CC} = 6.50$  V and  $V_{pp} = 13$  V (SNAPI Pulse),  $T_A = 25^\circ\text{C}$  (see Note 3)**

PARAMETER	MIN	MAX	UNIT
$t_{dis(G)}$ Output disable time from $\bar{G}$	0	130	ns
$t_{en(G)}$ Output enable time from $\bar{G}$		150	ns

NOTES: 3. For all switching characteristics the input pulse levels are 0.4 V to 2.4 V. Timing measurements are made at 2 V for logic high and 0.8 V for logic low. (Reference page 9.)

4. Common test conditions apply for the  $t_{dis}$  except during programming.

**recommended timing requirements for programming:  $V_{CC} = 6.5$  V and  $V_{pp} = 13$  V,  $T_A = 25^\circ\text{C}$  (see Note 3)**

	MIN	NOM	MAX	UNIT
$t_{h(A)}$ Hold time, address	0			$\mu\text{s}$
$t_{h(D)}$ Hold time, data	2			$\mu\text{s}$
$t_w(\text{IPGM})$ Pulse duration, initial program	95	100	105	$\mu\text{s}$
$t_{su(A)}$ Setup time, address	2			$\mu\text{s}$
$t_{su(G)}$ Setup time, $\bar{G}$	2			$\mu\text{s}$
$t_{su(E)}$ Setup time, $\bar{E}$	2			$\mu\text{s}$
$t_{su(D)}$ Setup time, data	2			$\mu\text{s}$
$t_{su(VPP)}$ Setup time, $V_{pp}$	2			$\mu\text{s}$
$t_{su(VCC)}$ Setup time, $V_{CC}$	2			$\mu\text{s}$

NOTE 3: For all switching characteristics the input pulse levels are 0.4 V to 2.4 V. Timing measurements are made at 2 V for logic high and 0.8 V for logic low. (Reference page 9.)



POST OFFICE BOX 1443 • HOUSTON, TEXAS 77251-1443

7-150

8961725 0085643 276



PARAMETER MEASUREMENT INFORMATION

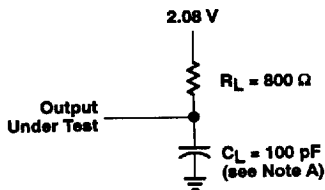

NOTE A:  $C_L$  includes probe and fixture capacitance.

Figure 2. AC Testing Output Load Circuit

AC testing input/output wave forms

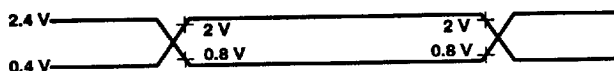

A.C. testing inputs are driven at 2.4 V for logic high and 0.4 V for logic low. Timing measurements are made at 2 V for logic high and 0.8 V for logic low for both inputs and outputs.

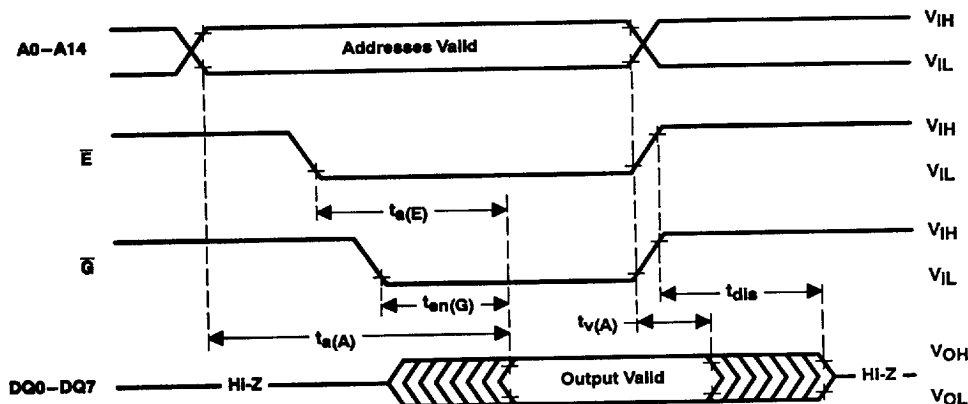

Figure 3. Read-Cycle Timing



POST OFFICE BOX 1449 • HOUSTON, TEXAS 77251-1449

**TMS27C256 262144-BIT UV ERASABLE PROGRAMMABLE  
TMS27PC256 262144-BIT PROGRAMMABLE  
READ-ONLY MEMORY**

SMLS256G - SEPTEMBER 1984 - REVISED JUNE 1995

**PARAMETER MEASUREMENT INFORMATION**

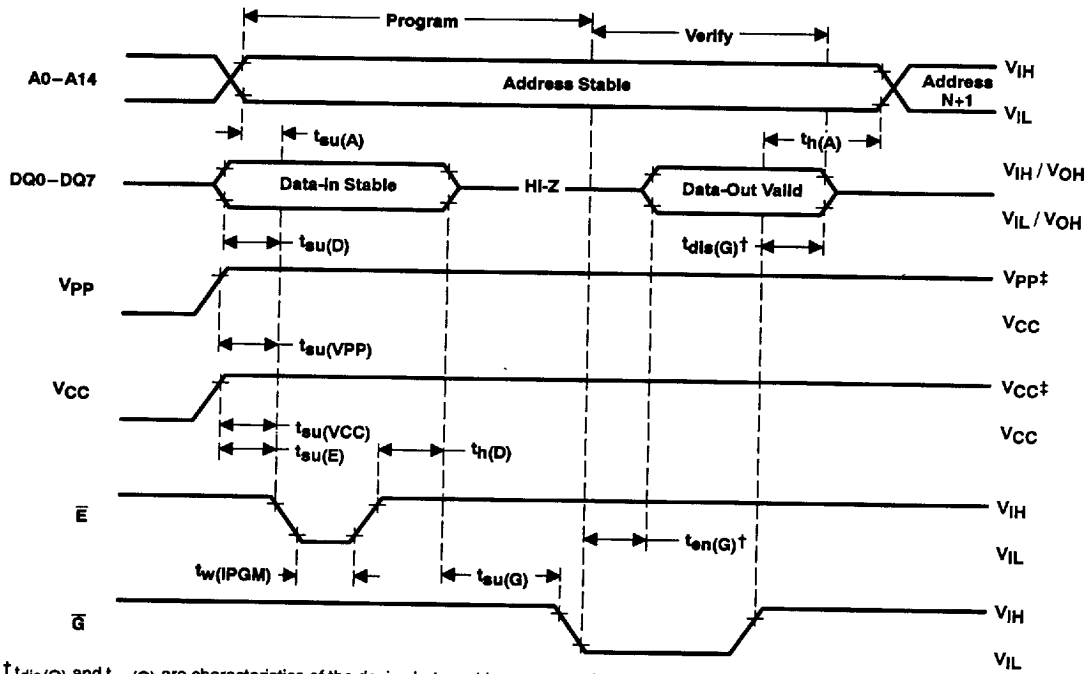

†  $t_{dis}(G)$  and  $t_{en}(G)$  are characteristics of the device but must be accommodated by the programmer  
‡ 13-V  $V_{PP}$  and 6.5-V  $V_{CC}$  for SNAPI Pulse programming

**Figure 4. Program-Cycle Timing (SNAPI Pulse Programming)**



POST OFFICE BOX 1443 • HOUSTON, TEXAS 77251-1443

7-152

8961725 0085645 049

TMS27C256 262144-BIT UV ERASABLE PROGRAMMABLE  
TMS27PC256 262144-BIT PROGRAMMABLE  
READ-ONLY MEMORY

SMLS256G - SEPTEMBER 1984 - REVISED JUNE 1995

device symbolization

This data sheet is applicable to all TI TMS27C256 CMOS EPROMs and TMS27PC256 CMOS OTP PROMs with the data sheet revision code "B" as shown below.

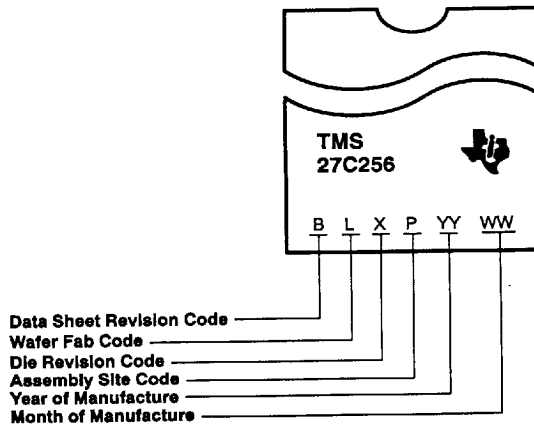
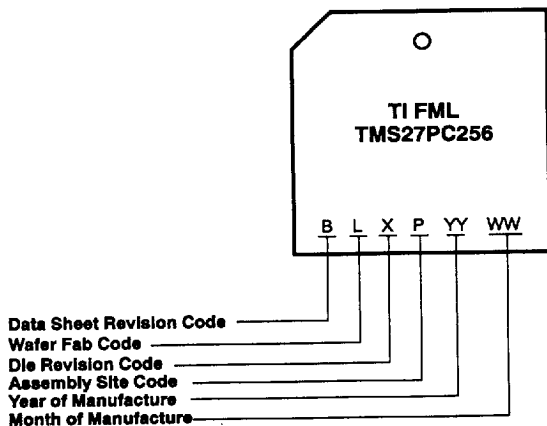

POST OFFICE BOX 1443 • HOUSTON, TEXAS 77251-1443

7-153

8961725 0085646 T85

**TMS27C256 262 144-BIT UV ERASABLE PROGRAMMABLE  
TMS27PC256 262 144-BIT PROGRAMMABLE  
READ-ONLY MEMORY**

SMLS256G - SEPTEMBER 1984 - REVISED JUNE 1995

**TYPICAL TMS27C/PC256 CHARACTERISTICS**

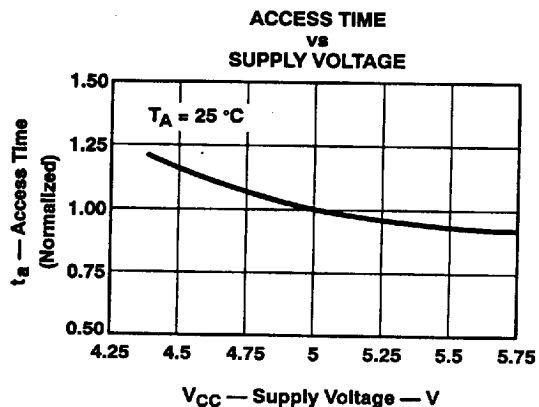
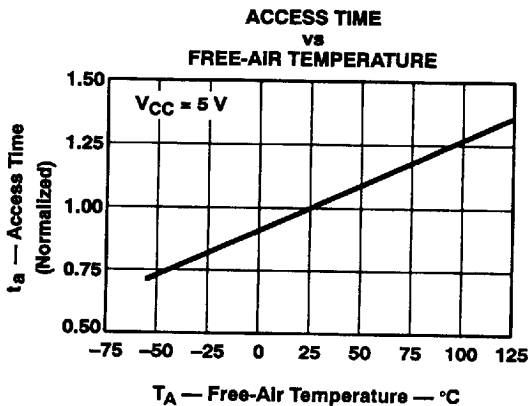
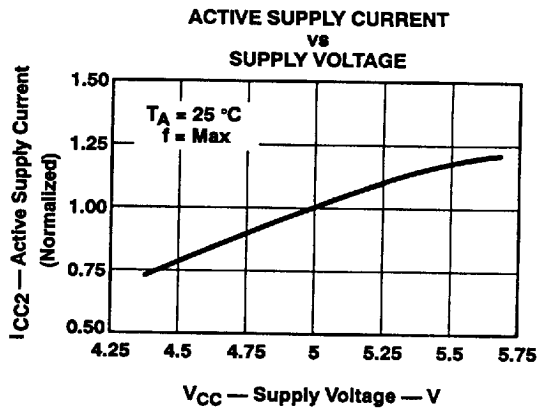
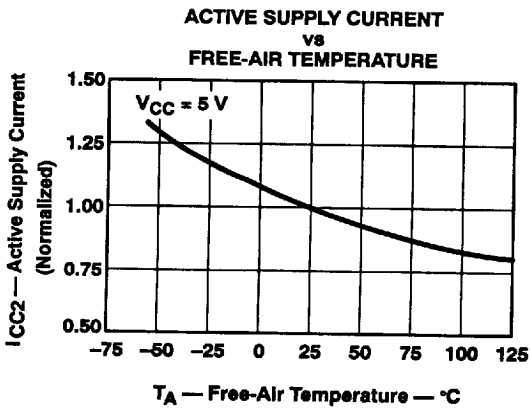
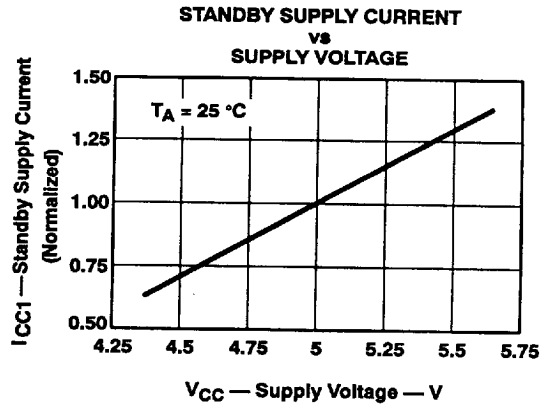
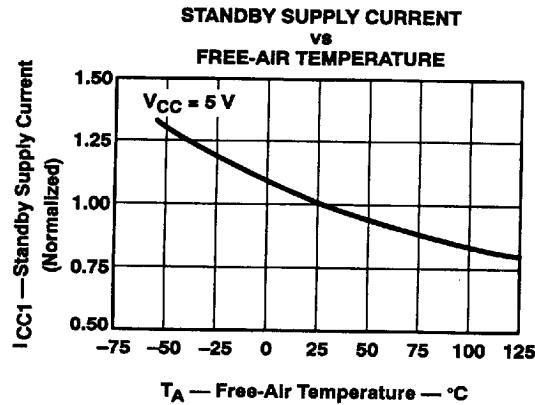

7-154

POST OFFICE BOX 1443 • HOUSTON, TEXAS 77251-1443

8961725 0085647 911