

Component General, Inc.

■ Stripline Base Mounted Terminations

■ MECHANICAL SPECIFICATIONS



Heat Sink : Copper, Nickel Plated per QQ-N-290.

Substrate : Beryllium Oxide Ceramic.

Contact : Beryllium Copper, Gold Plated per MIL-G-45204.

Thickness : .004" ± .002".

Cover : Alumina Ceramic.

Tolerance : ± .010" unless specified

2 hole base mounted terminations product selection chart

CGI P/N	Power	Resistance (Ohms)	Standard Tolerance	Frequency Range	VSWR (Max.)
Note: Click a part number from the list below to see a data sheet for that part.					
CBT-10	10 W	50	5 %	DC - 4.0 GHz	1:35:1
CBT-10-5	10 W	50	5 %	DC - 8.0 GHz	1:25:1
CBT-40	40 W	50	5 %	DC - 6.0 GHz	1:25:1
CBT-40-1	40 W	50	5 %	DC - 6.0 GHz	1:25:1
CBT-75	75 W	50	5 %	DC - 1.0 GHz 1.0 - 1.5 GHz	1:10:1 1:35:1
CBT-80	80 W	50	5 %	DC - 6.0 GHz	1:25:1
CBT-125	125 W	50	5 %	—	1:20:1 1:35:1
CBT-150	150 W	50	5 %	DC - .5 GHz .5 - 1.0 GHz	1:20:1 1:35:1
CBT-150-1	150 W	50	5 %	DC - 2.0 GHz	1:25:1
CBT-150-2	150 W	50	5 %	DC - .5 GHz .5 - 1.0 GHz	1:20:1 1:35:1
CBT-150-3	150 W	50	5 %	DC - 2.0 GHz	1:25:1
CBT-150-4	150 W	50	5 %	DC - 2.0 GHz	1:25:1
CBT-150-5	150 W	50	5 %	—	1:20:1 1:35:1

Component General, Inc.

■ Stripline Base Mounted Terminations

■ MECHANICAL SPECIFICATIONS



Heat Sink : Copper, Nickel Plated per QQ-N-290.

Substrate : Beryllium Oxide Ceramic.

Contact : Beryllium Copper, Gold Plated per MIL-G-45204.

Thickness : .004" ± .002".

Cover : Alumina Ceramic.

Tolerance : ± .010" unless specified

2 hole base mounted terminations product selection chart

CGI P/N	Power	Resistance (Ohms)	Standard Tolerance	Frequency Range	VSWR (Max.)
Note: Click a part number from the list below to see a data sheet for that part.					
CBT-250	250 W	50	5 %	DC - 1.0 GHz 1.0 - 1.5 GHz	1:20:1 1:35.1
CBT-250-1	250 W	50	5 %	DC - 1.0 GHz	1:25:1
CBT-250-2	250 W	50	5 %	DC - .5 GHz .5 - 2.5 GHz	1:10:1 1:35.1
CBT-250-4	250 W	50	5 %	DC - 2.0 GHz 2.0 - 2.4 GHz	1:10:1 1:20.1
CBT-250-5	250 W	50	5 %	DC - 2.0 GHz 2.0 - 2.4 GHz	1:10:1 1:20.1
CBT-370	370 W	50	5 %	DC - .75 GHz	1:35.1
CBT-400	400 W	50	5 %	DC - .5 GHz .5 - .75 GHz	1:25:1 1:35.1

Component General, Inc.

P/N: CBT-10

Stripline Base Mounted Terminations

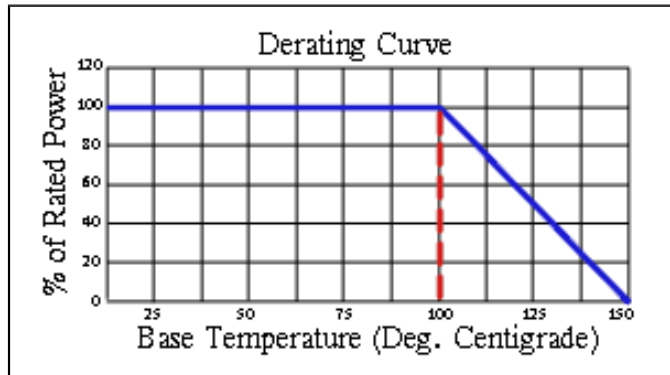
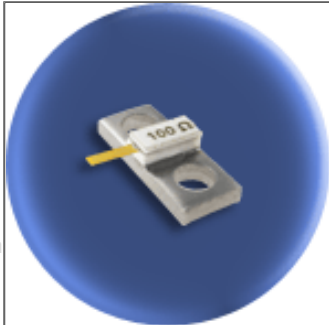

Mechanical Specifications

Covers:

Alumina Ceramic.

Substrate:

Beryllium Oxide Ceramic.

Contact:

Beryllium Copper, Gold Plated per MIL-G-45204. Length: 0.125" Min., Width: 0.040", Thickness 0.004" ± 0.002".

Heat Sink:

Copper, Nickel Plated per QQ-N-290.

Tolerance:

± 0.010" unless specified.

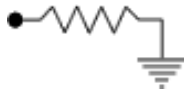

Note: The use of thermal mounting compound is recommended.

Electrical Specifications

Resistance Value:

10 - 1000 Ω or as required. Other values available upon request.

Frequency Range:

DC - 4.0 GHz

VSWR (Max.):

1.35:1

Standard Resistance Tolerance:

± 5% Other tolerances available upon request.

Part Dimensions

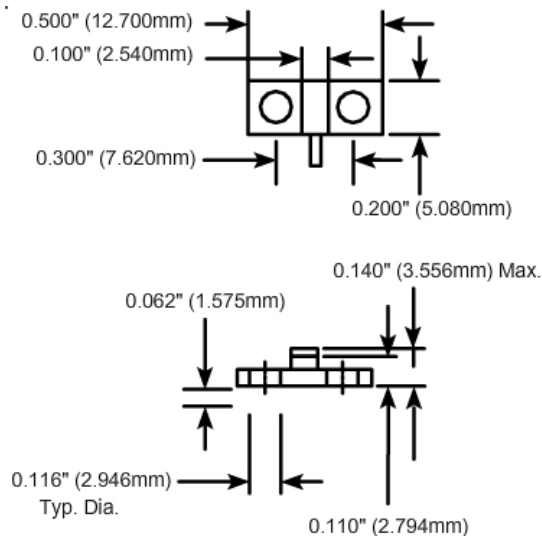

Component General, Inc.

P/N: CBT-10-5

Stripline Base Mounted Terminations

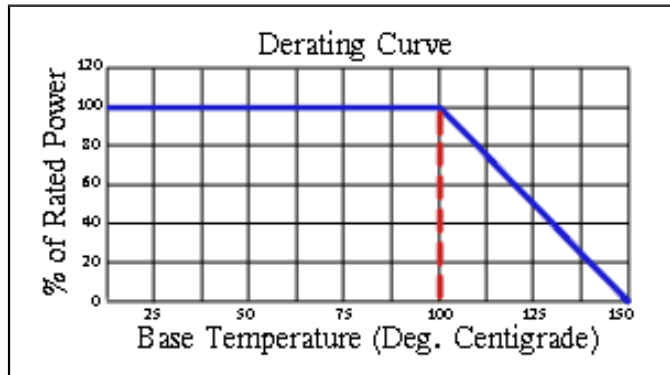
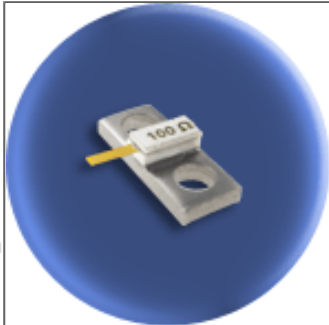

Mechanical Specifications

Covers:

Alumina Ceramic.

Substrate:

Beryllium Oxide Ceramic.

Contact:

Beryllium Copper, Gold Plated per MIL-G-45204.
Length: 0.125" Min., Width: 0.040",
Thickness 0.004" ± 0.002".

Heat Sink:

Copper, Nickel Plated per QQ-N-290.

Tolerance:

± 0.010" unless specified.

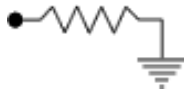

Note: The use of thermal mounting compound is recommended.

Electrical Specifications

Resistance Value:

10 - 1000 Ω or as required. Other values available upon request.

Frequency Range:

DC - 8.0 GHz

VSWR (Max.):

1.25:1

Standard Resistance Tolerance:

± 5% Other tolerances available upon request.

Part Dimensions

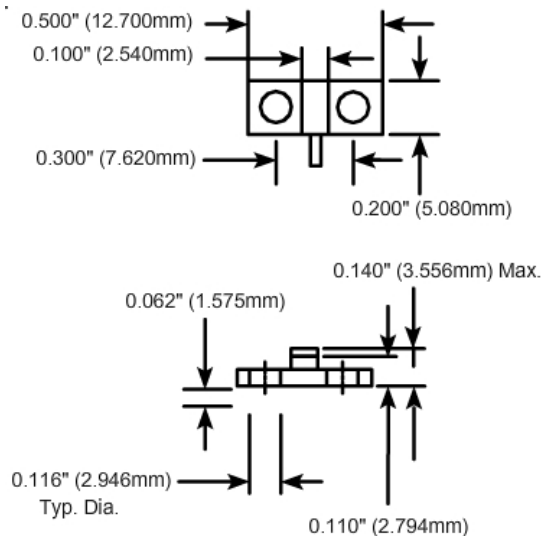

Component General, Inc.

P/N: CBT-40

Stripline Base Mounted Terminations

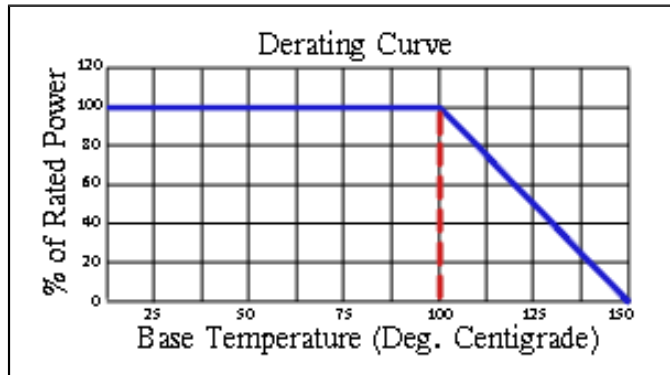
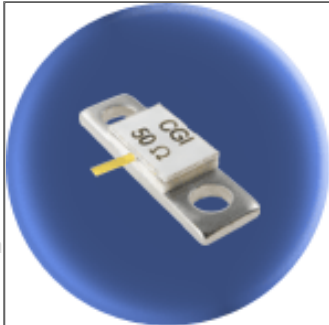

Mechanical Specifications

Covers:

Alumina Ceramic.

Substrate:

Beryllium Oxide Ceramic.

Contact:

Beryllium Copper, Gold Plated per MIL-G-45204.
Length: 0.125" Min., Width: 0.040",
Thickness 0.004" \pm 0.002".

Heat Sink:

Copper, Nickel Plated per QQ-N-290.

Tolerance:

\pm 0.010" unless specified.

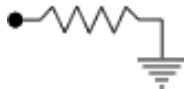

Note: The use of thermal mounting compound is recommended.

Electrical Specifications

Resistance Value:

10 - 1000 Ω or as required. Other values available upon request.

Frequency Range:

DC - 6.0 GHz

VSWR (Max.):

1.25:1

Standard Resistance Tolerance:

\pm 5% Other tolerances available upon request.

Part Dimensions

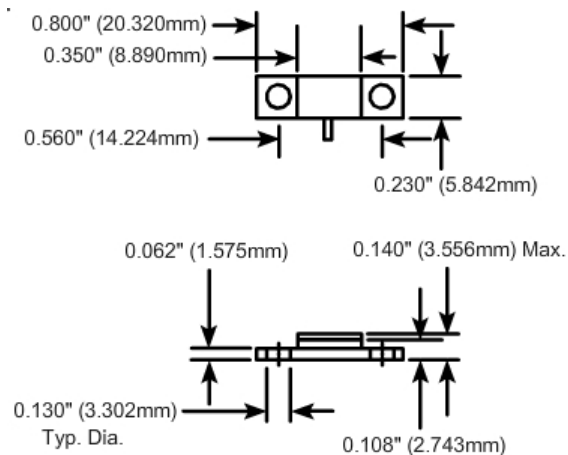

Component General, Inc.

P/N: CBT-40-1

Stripline Base Mounted Terminations

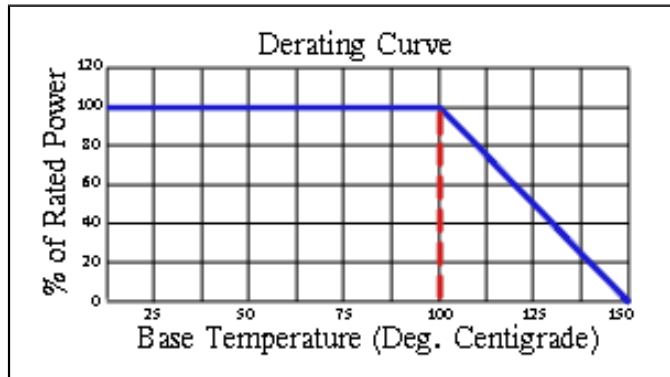
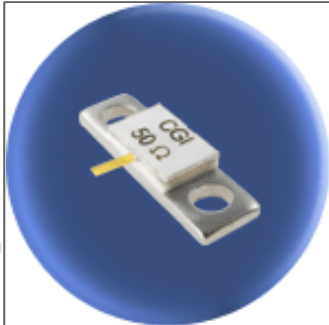

Mechanical Specifications

Covers:

Alumina Ceramic.

Substrate:

Beryllium Oxide Ceramic.

Contact:

Beryllium Copper, Gold Plated per MIL-G-45204.
Length: 0.125" Min., Width: 0.040",
Thickness 0.004" \pm 0.002".

Heat Sink:

Copper, Nickel Plated per QQ-N-290.

Tolerance:

\pm 0.010" unless specified.

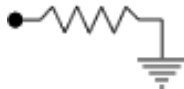

Note: The use of thermal mounting compound is recommended.

Electrical Specifications

Resistance Value:

10 - 1000 Ω or as required. Other values available upon request.

Frequency Range:

DC - 6.0 GHz

VSWR (Max.):

1.25:1

Standard Resistance Tolerance:

\pm 5% Other tolerances available upon request.

Part Dimensions

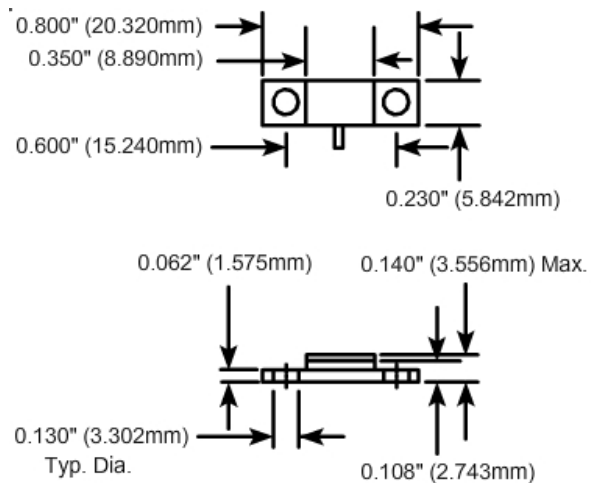

Component General, Inc.

P/N: CBT-75

Stripline Base Mounted Terminations

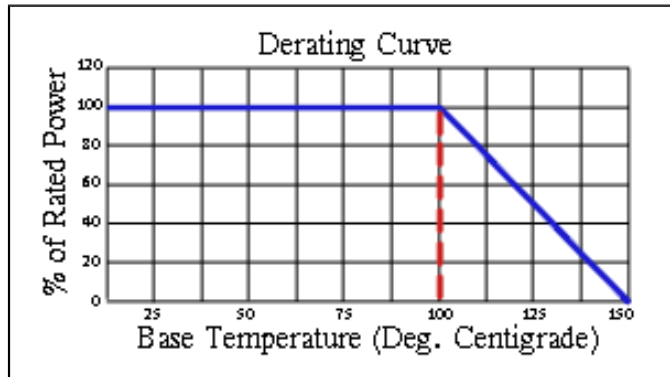

Mechanical Specifications

Covers:

Alumina Ceramic.

Substrate:

Beryllium Oxide Ceramic.

Contact:

Beryllium Copper, Gold Plated per MIL-G-45204.
Length 0.125" min., Width 0.250"
Thickness 0.004" ± 0.002".

Heat Sink:

Copper, Nickel Plated per QQ-N-290.

Tolerance:

± 0.010" unless specified.

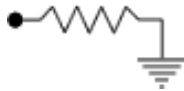

Note: The use of thermal mounting compound is recommended.

Electrical Specifications

Resistance Value:

10 - 1000 Ω or as required. Other values available upon request.

Frequency Range:

DC - 1.0 GHz
1.0 - 1.5 GHz

VSWR (Max.):

1.10:1
1.35:1

Standard Resistance Tolerance:

± 5% Other tolerances available upon request.

Part Dimensions

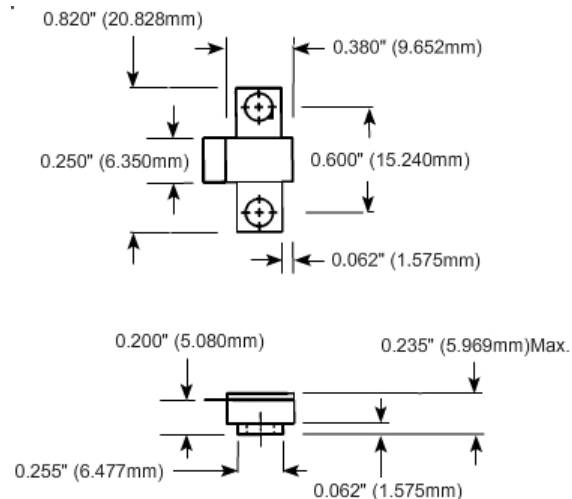

Component General, Inc.

P/N: CBT-80

Stripline Base Mounted Terminations

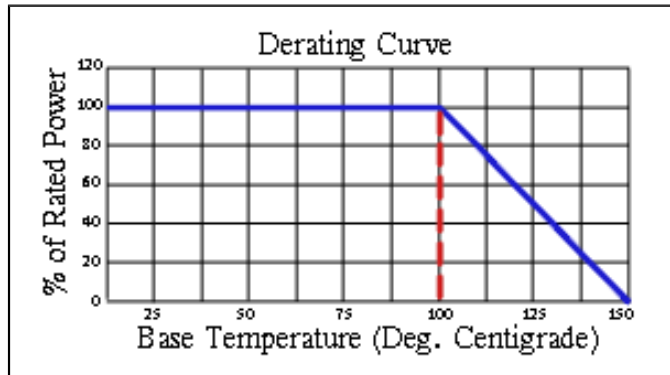
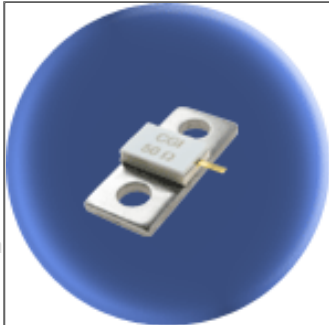

Mechanical Specifications

Covers:

Alumina Ceramic.

Substrate:

Beryllium Oxide Ceramic.

Contact:

Beryllium Copper, Gold Plated per MIL-G-45204.
Length: 0.125" Min., Width: 0.040",
Thickness 0.004" ± 0.002".

Heat Sink:

Copper, Nickel Plated per QQ-N-290.

Tolerance:

± 0.010" unless specified.

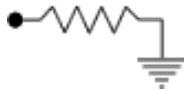

Note: The use of thermal mounting compound is recommended.

Electrical Specifications

Resistance Value:

10 - 1000 Ω or as required. Other values available upon request.

Frequency Range:

DC - 6.0 GHz

VSWR (Max.):

1.25:1

Standard Resistance Tolerance:

± 5% Other tolerances available upon request.

Part Dimensions

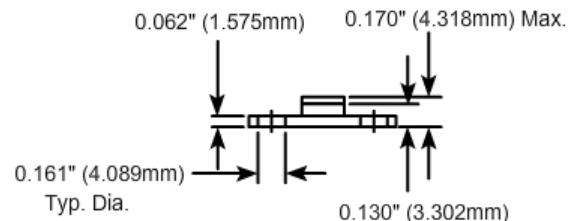
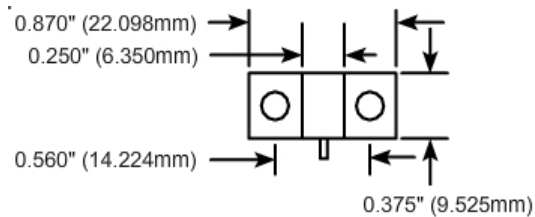

Component General, Inc.

P/N: CBT-125

Stripline Base Mounted Terminations

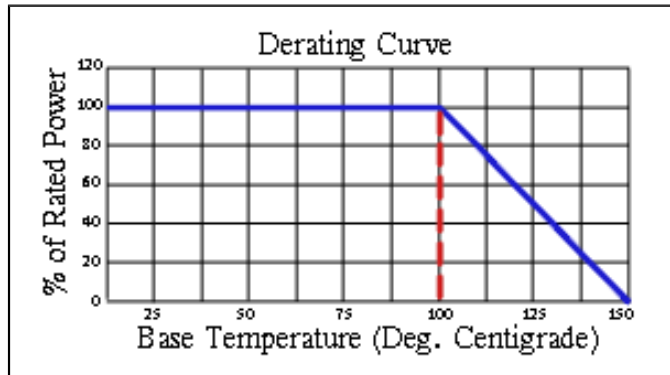
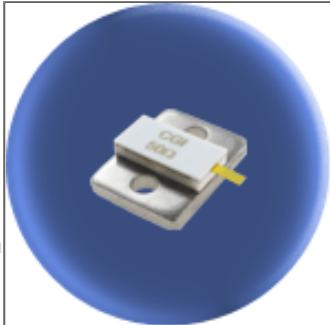

Mechanical Specifications

Covers:

Alumina Ceramic.

Substrate:

Beryllium Oxide Ceramic.

Contact:

Beryllium Copper, Gold Plated per MIL-G-45204.
Length: 0.125" Min., Width: 0.060",
Thickness 0.004" ± 0.002".

Heat Sink:

Copper, Nickel Plated per QQ-N-290.

Tolerance:

± 0.010" unless specified.

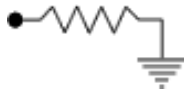

Note: The use of thermal mounting compound is recommended.

Electrical Specifications

Resistance Value:

10 - 1000 Ω or as required. Other values available upon request.

Frequency Range:

DC - 1.0 GHz
1.0 - 2.0 GHz
2.0 - 3.0 GHz

VSWR (Max.):

1.15:1
1.20:1
1.25:1

Standard Resistance Tolerance:

± 5% Other tolerances available upon request.

Part Dimensions

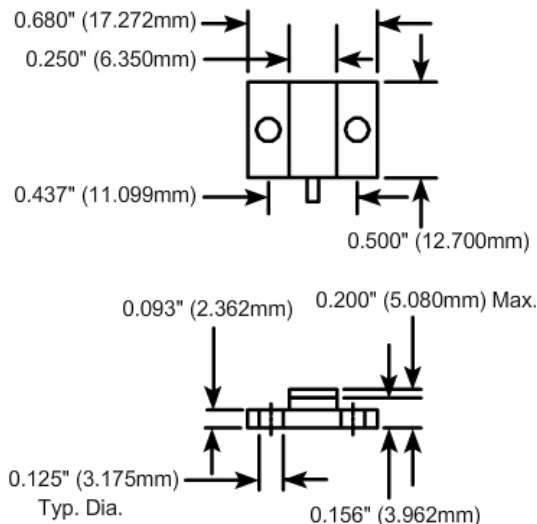

Component General, Inc.

P/N: CBT-150

Stripline Base Mounted Terminations

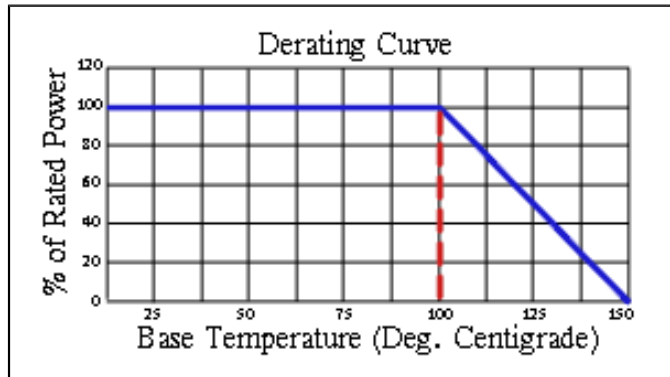
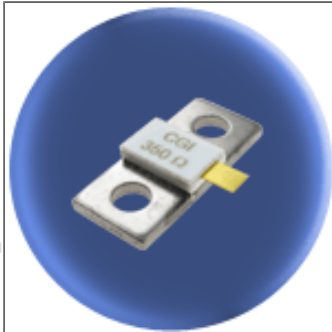

Mechanical Specifications

Covers:

Alumina Ceramic.

Substrate:

Beryllium Oxide Ceramic.

Contact:

Beryllium Copper, Gold Plated per MIL-G-45204.
Length: 0.125" Min., Width: 0.120",
Thickness 0.004" ± 0.002".

Heat Sink:

Copper, Nickel Plated per QQ-N-290.

Tolerance:

± 0.010" unless specified.

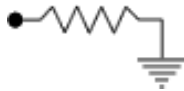

Note: The use of thermal mounting compound is recommended.

Electrical Specifications

Resistance Value:

10 - 1000 Ω or as required. Other values available upon request.

Frequency Range:

DC - .5 GHz
.5 - 1.0 GHz

VSWR (Max.):

1.20:1
1.35:1

Standard Resistance Tolerance:

± 5% Other tolerances available upon request.

Part Dimensions

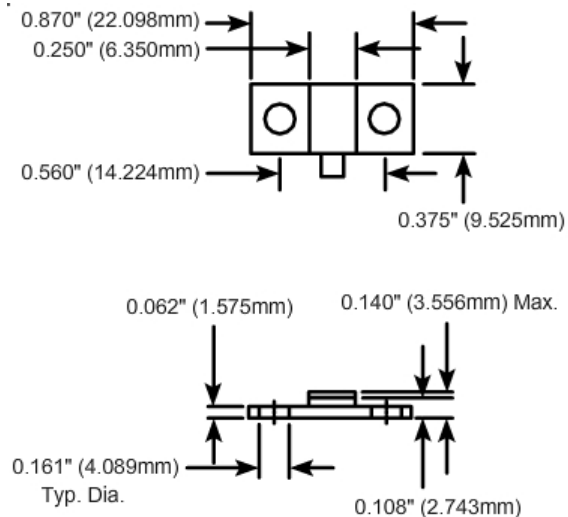

Component General, Inc.

P/N: CBT-150-1

Stripline Base Mounted Terminations

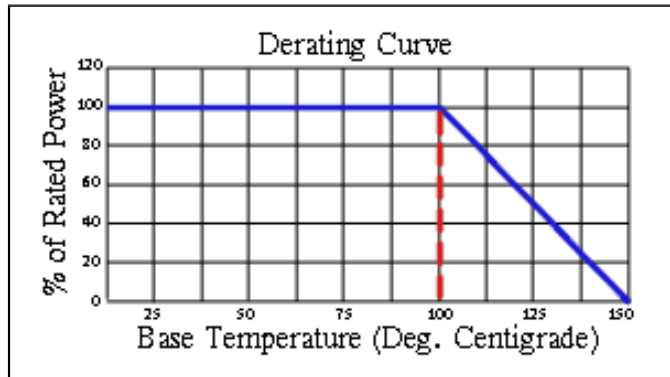
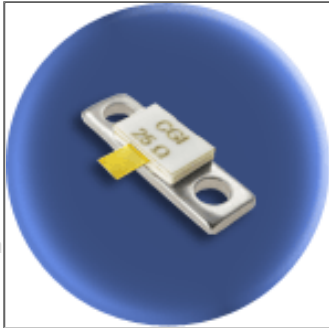

Mechanical Specifications

Covers:

Alumina Ceramic.

Substrate:

Beryllium Oxide Ceramic.

Contact:

Beryllium Copper, Gold Plated per MIL-G-45204.
Length: 0.125" Min., Width: 0.120",
Thickness 0.004" \pm 0.002".

Heat Sink:

Copper, Nickel Plated per QQ-N-290.

Tolerance:

\pm 0.010" unless specified.

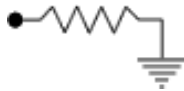

Note: The use of thermal mounting compound is recommended.

Electrical Specifications

Resistance Value:

10 - 1000 Ω or as required. Other values available upon request.

Frequency Range:

DC - 2.0 GHz

VSWR (Max.):

1.25:1

Standard Resistance Tolerance:

\pm 5% Other tolerances available upon request.

Part Dimensions

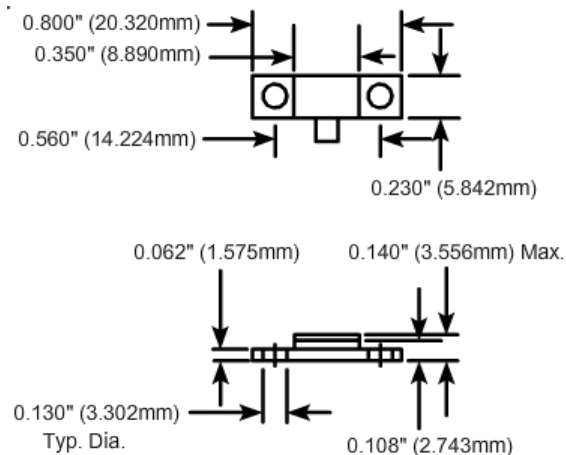

Component General, Inc.

P/N: CBT-150-2

Stripline Base Mounted Terminations

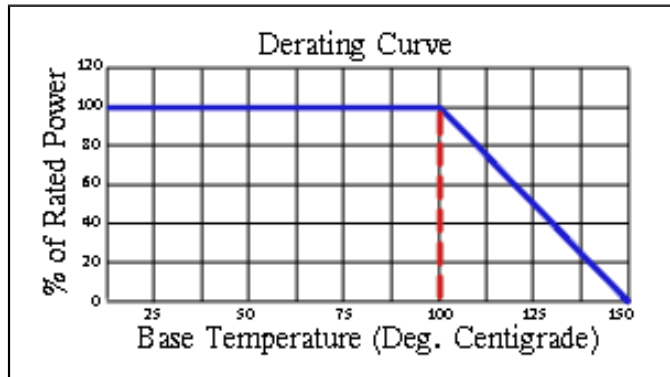

Mechanical Specifications

Covers:

Alumina Ceramic.

Substrate:

Beryllium Oxide Ceramic.

Contact:

Beryllium Copper, Gold Plated per MIL-G-45204.
Length: 0.125" Min., Width: 0.120",
Thickness 0.004" ± 0.002".

Heat Sink:

Copper, Nickel Plated per QQ-N-290.

Tolerance:

± 0.010" unless specified.

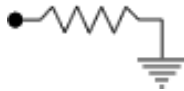

Note: The use of thermal mounting compound is recommended.

Electrical Specifications

Resistance Value:

10 - 1000 Ω or as required. Other values available upon request.

Frequency Range:

DC - .5 GHz
.5 - 1.0 GHz

VSWR (Max.):

1.20:1
1.35:1

Standard Resistance Tolerance:

± 5% Other tolerances available upon request.

Part Dimensions

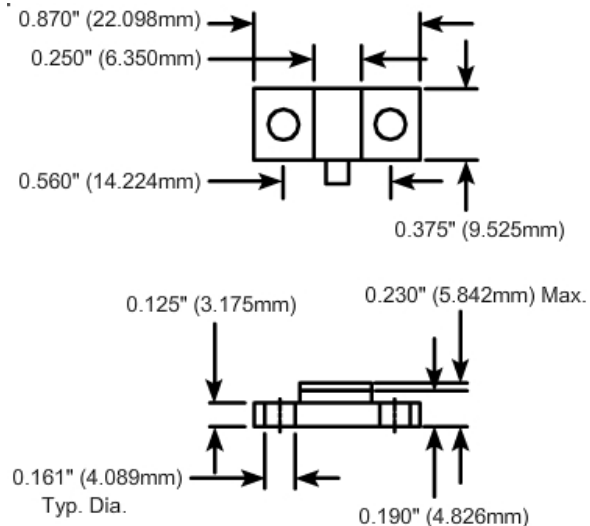

Component General, Inc.

P/N: CBT-150-3

Stripline Base Mounted Terminations

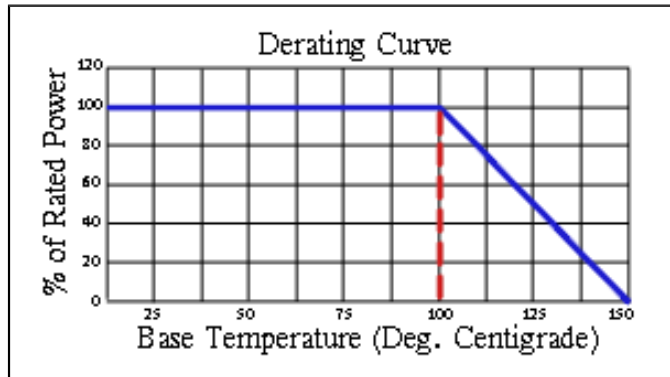
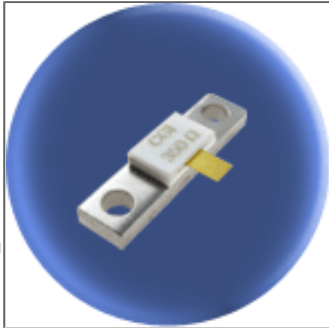

Mechanical Specifications

Covers:

Alumina Ceramic.

Substrate:

Beryllium Oxide Ceramic.

Contact:

Beryllium Copper, Gold Plated per MIL-G-45204.
Length: 0.125" Min., Width: 0.120",
Thickness 0.004" ± 0.002".

Heat Sink:

Copper, Nickel Plated per QQ-N-290.

Tolerance:

± 0.010" unless specified.

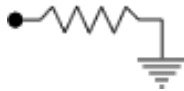

Note: The use of thermal mounting compound is recommended.

Electrical Specifications

Resistance Value:

10 - 1000 Ω or as required. Other values available upon request.

Frequency Range: VSWR (Max.):

DC - 2.0 GHz

1.25:1

Standard Resistance Tolerance:

± 5% Other tolerances available upon request.

Part Dimensions

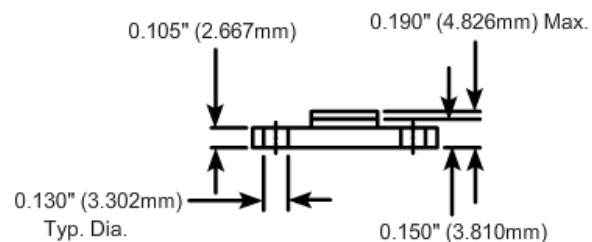
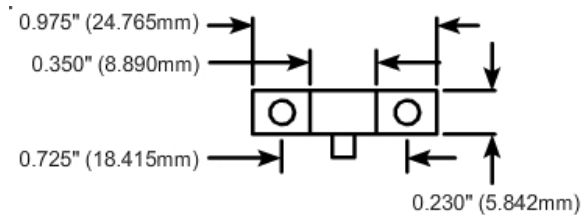

Component General, Inc.

P/N: CBT-150-4

Stripline Base Mounted Terminations

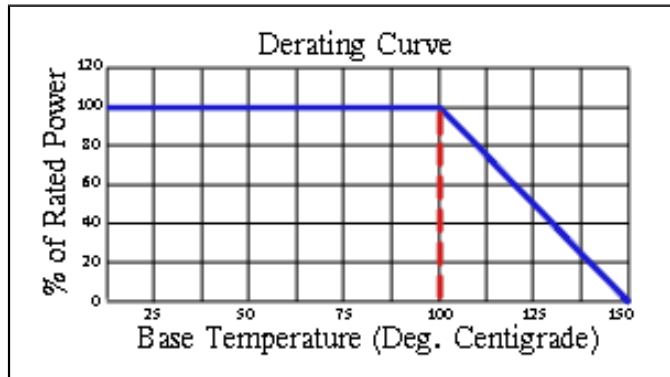
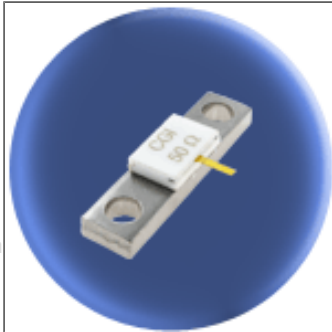

Mechanical Specifications

Covers:

Alumina Ceramic.

Substrate:

Beryllium Oxide Ceramic.

Contact:

Beryllium Copper, Gold Plated per MIL-G-45204.
Length: 0.125" Min., Width: 0.040",
Thickness 0.004" \pm 0.002".

Heat Sink:

Copper, Nickel Plated per QQ-N-290.

Tolerance:

\pm 0.010" unless specified.

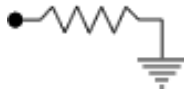

Note: The use of thermal mounting compound is recommended.

Electrical Specifications

Resistance Value:

10 - 1000 Ω or as required. Other values available upon request.

Frequency Range:

DC - 2.0 GHz

VSWR (Max.):

1.25:1

Standard Resistance Tolerance:

\pm 5% Other tolerances available upon request.

Part Dimensions

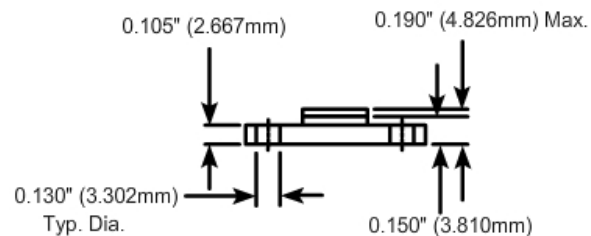
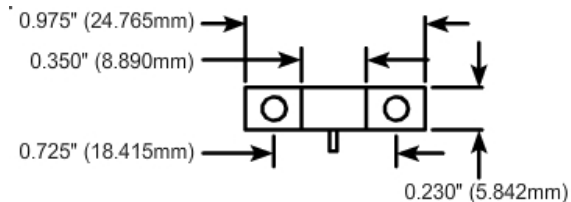

Component General, Inc.

P/N: CBT-150-5

Stripline Base Mounted Terminations

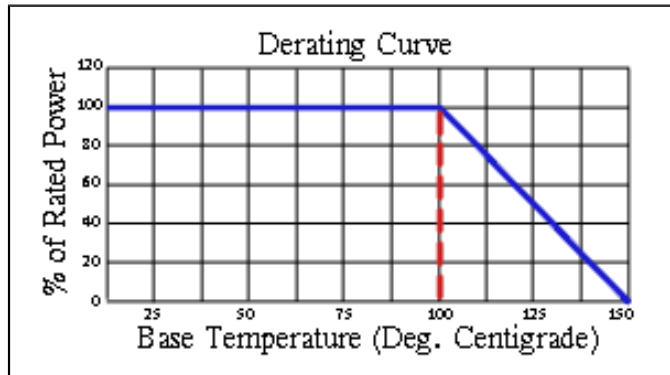
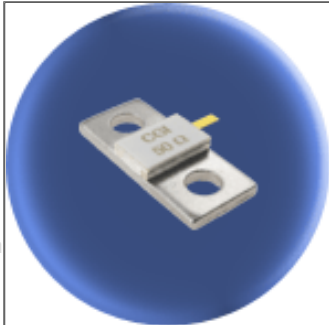

Mechanical Specifications

Covers:

Alumina Ceramic.

Substrate:

Beryllium Oxide Ceramic.

Contact:

Beryllium Copper, Gold Plated per MIL-G-45204. Length: 0.125" Min., Width: 0.060", Thickness 0.004" ± 0.002".

Heat Sink:

Copper, Nickel Plated per QQ-N-290.

Tolerance:

± 0.010" unless specified.

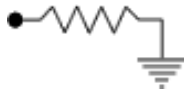

Note: The use of thermal mounting compound is recommended.

Electrical Specifications

Resistance Value:

10 - 1000 Ω or as required. Other values available upon request.

Frequency Range:

DC - 1.0 GHz
1.0 - 2.0 GHz
2.0 - 3.0 GHz

VSWR (Max.):

1.08:1
1.09:1
1.15:1

Standard Resistance Tolerance:

± 5% Other tolerances available upon request.

Part Dimensions

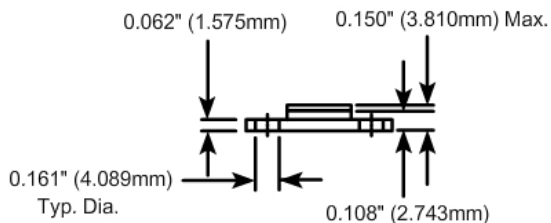
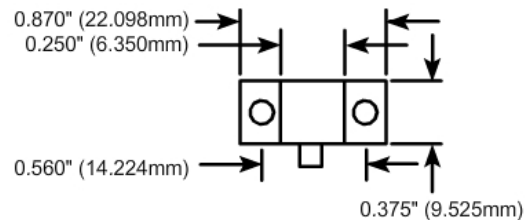

Component General, Inc.

P/N: CBT-250

Stripline Base Mounted Terminations

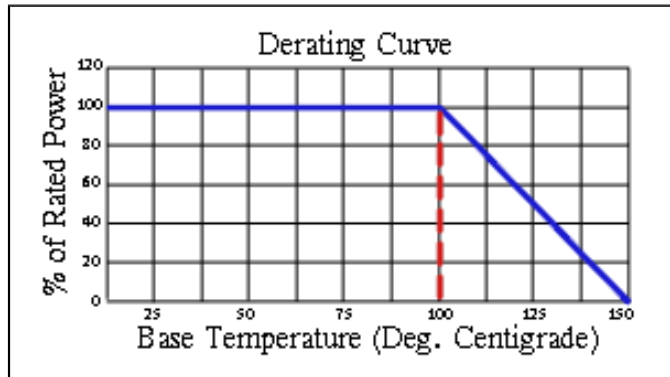
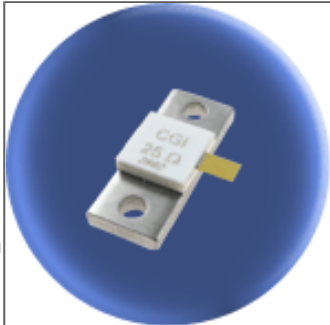

Mechanical Specifications

Covers:

Alumina Ceramic.

Substrate:

Beryllium Oxide Ceramic.

Contact:

Beryllium Copper, Gold Plated per MIL-G-45204.
Length: 0.125" Min., Width: 0.120",
Thickness 0.004" ± 0.002".

Heat Sink:

Copper, Nickel Plated per QQ-N-290.

Tolerance:

± 0.010" unless specified.

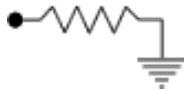

Note: The use of thermal mounting compound is recommended.

Electrical Specifications

Resistance Value:

10 - 1000 Ω or as required. Other values available upon request.

Frequency Range:

DC - 1.0 GHz
1.0 - 1.5 GHz

VSWR (Max.):

1.20:1
1.35:1

Standard Resistance Tolerance:

± 5% Other tolerances available upon request.

Part Dimensions

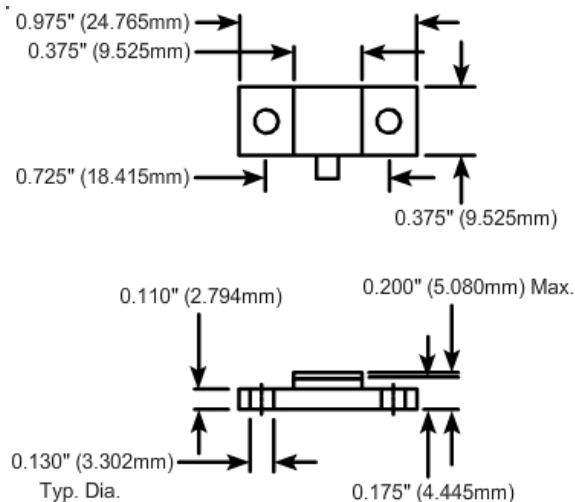

Component General, Inc.

P/N: CBT-250-1

Stripline Base Mounted Terminations

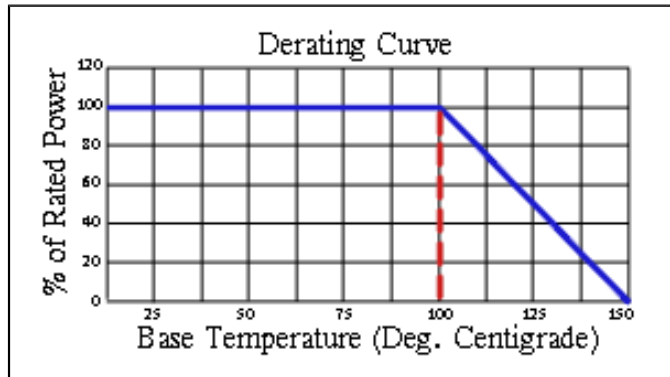
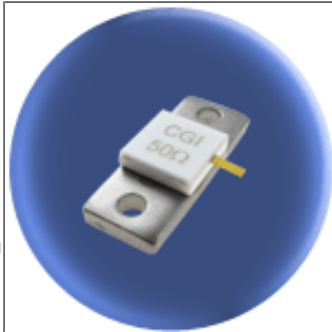

Mechanical Specifications

Covers:

Alumina Ceramic.

Substrate:

Beryllium Oxide Ceramic.

Contact:

Beryllium Copper, Gold Plated per MIL-G-45204.
Length: 0.125" Min., Width: 0.060",
Thickness 0.004" ± 0.002".

Heat Sink:

Copper, Nickel Plated per QQ-N-290.

Tolerance:

± 0.010" unless specified.

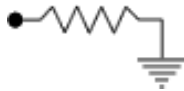

Note: The use of thermal mounting compound is recommended.

Electrical Specifications

Resistance Value:

10 - 1000 Ω or as required. Other values available upon request.

Frequency Range:

DC - 1.0 GHz

VSWR (Max.):

1.25:1

Standard Resistance Tolerance:

± 5% Other tolerances available upon request.

Part Dimensions

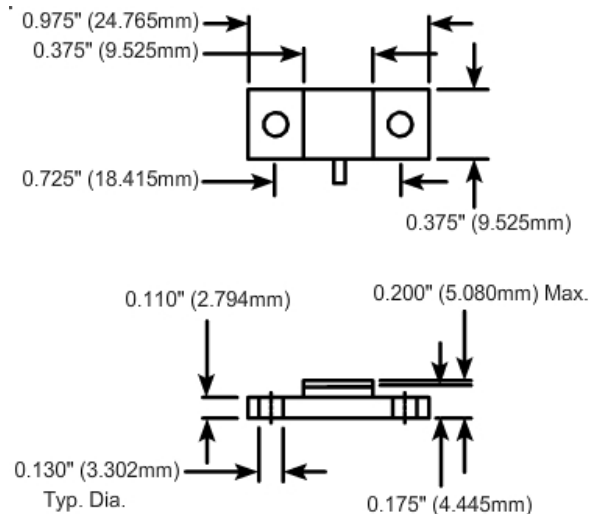

Component General, Inc.

P/N: CBT-250-2

Stripline Base Mounted Terminations

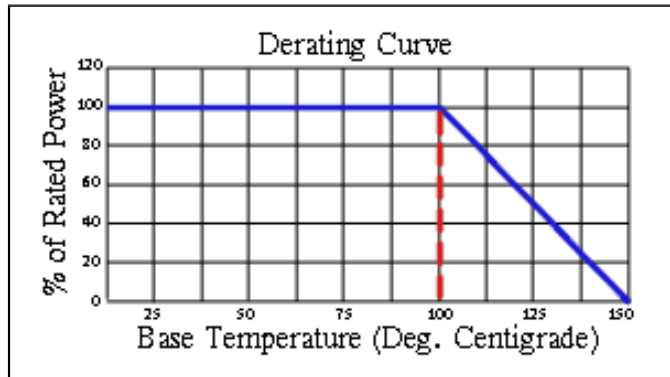
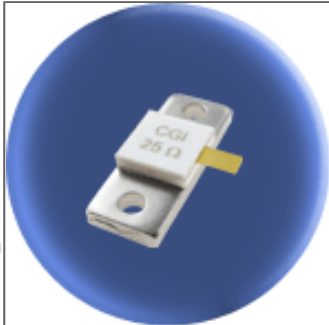

Mechanical Specifications

Covers:

Alumina Ceramic.

Substrate:

Beryllium Oxide Ceramic.

Contact:

Beryllium Copper, Gold Plated per MIL-G-45204.
Length: 0.125" Min., Width: 0.120",
Thickness 0.004" ± 0.002".

Heat Sink:

Copper, Nickel Plated per QQ-N-290.

Tolerance:

± 0.010" unless specified.

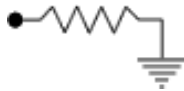

Note: The use of thermal mounting compound is recommended.

Electrical Specifications

Resistance Value:

10 - 1000 Ω or as required. Other values available upon request.

Frequency Range:

DC - .5 GHz
.5 - 2.5 GHz

VSWR (Max.):

1.10:1
1.35:1

Standard Resistance Tolerance:

± 5% Other tolerances available upon request.

Part Dimensions

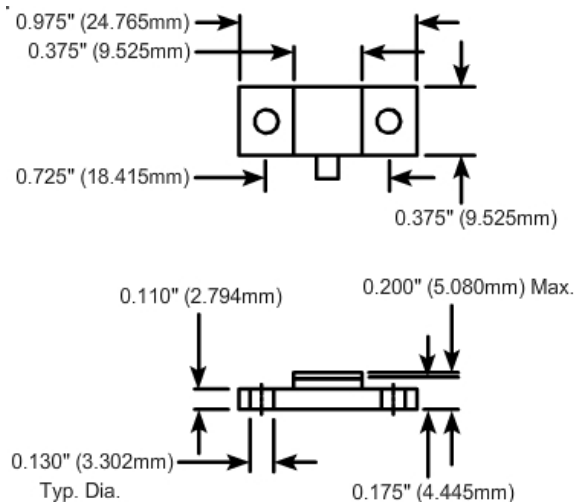

Component General, Inc.

P/N: CBT-250-4

Stripline Base Mounted Terminations

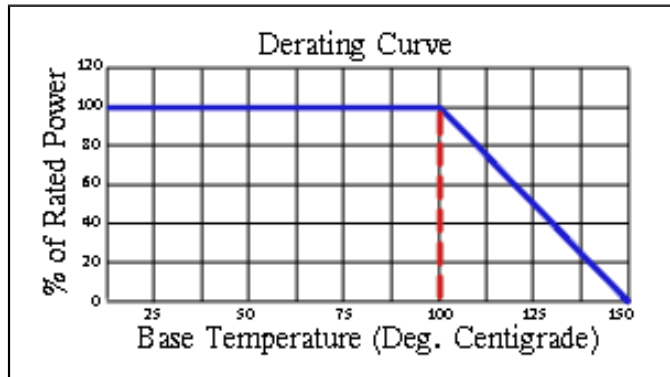
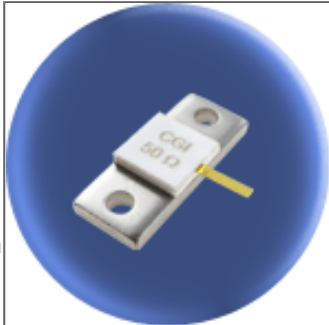

Mechanical Specifications

Covers:

Alumina Ceramic.

Substrate:

Beryllium Oxide Ceramic.

Contact:

Beryllium Copper, Gold Plated per MIL-G-45204.
Length: 0.200" Min., Width: 0.060",
Thickness 0.004" ± 0.002".

Heat Sink:

Copper, Nickel Plated per QQ-N-290.

Tolerance:

± 0.010" unless specified.

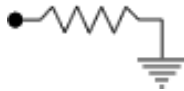

Note: The use of thermal mounting compound is recommended.

Electrical Specifications

Resistance Value:

10 - 1000 Ω or as required. Other values available upon request.

Frequency Range:

DC - 2.0 GHz
2.0 - 2.4 GHz

VSWR (Max.):

1.10:1
1.20:1

Standard Resistance Tolerance:

± 5% Other tolerances available upon request.

Part Dimensions

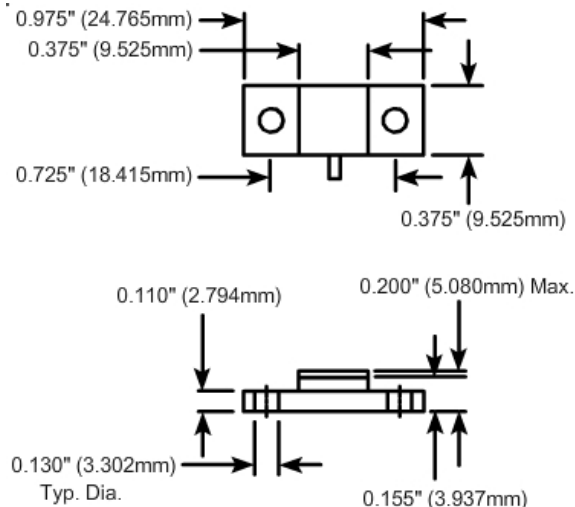

Component General, Inc.

P/N: CBT-250-5

Stripline Base Mounted Terminations

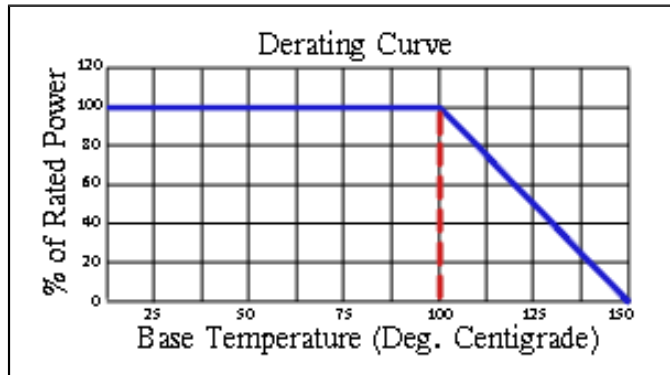
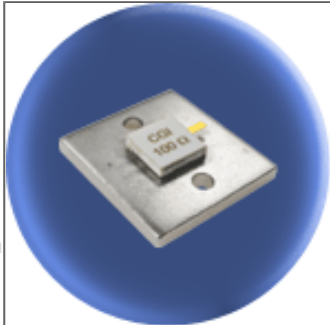

Mechanical Specifications

Covers:

Alumina Ceramic.

Substrate:

Beryllium Oxide Ceramic.

Contact:

Beryllium Copper, Gold Plated per MIL-G-45204.
Length: 0.200" Min., Width: 0.060",
Thickness 0.004" ± 0.002".

Heat Sink:

Copper, Nickel Plated per QQ-N-290.

Tolerance:

± 0.010" unless specified.

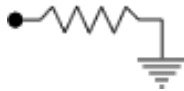

Note: The use of thermal mounting compound is recommended.

Electrical Specifications

Resistance Value:

10 - 1000 Ω or as required. Other values available upon request.

Frequency Range:

DC - 2.0 GHz
2.0 - 2.4 GHz

VSWR (Max.):

1.10:1
1.20:1

Standard Resistance Tolerance:

± 5% Other tolerances available upon request.

Part Dimensions

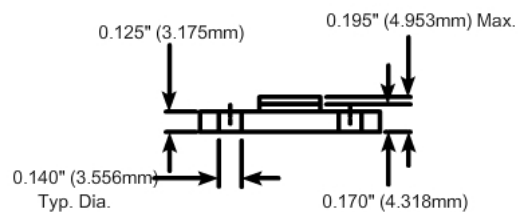
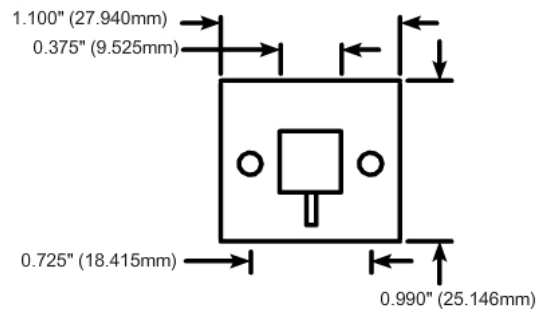

Component General, Inc.

P/N: CBT-370

Stripline Base Mounted Terminations

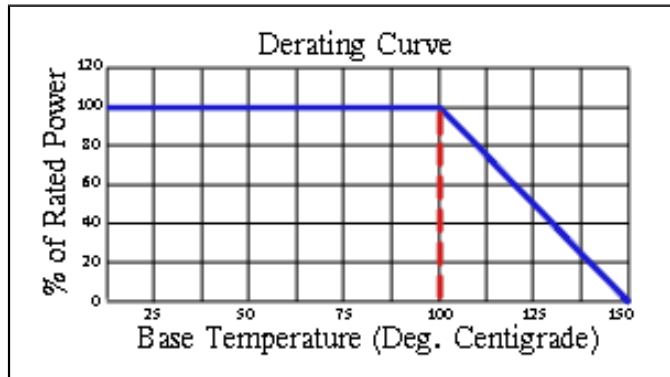

Mechanical Specifications

Covers:

Alumina Ceramic.

Substrate:

Beryllium Oxide Ceramic.

Contact:

Beryllium Copper, Gold Plated per MIL-G-45204.
Length: 0.125" Min., Width: 0.120",
Thickness 0.004" \pm 0.002".

Heat Sink:

Copper, Nickel Plated per QQ-N-290.

Tolerance:

\pm 0.010" unless specified.

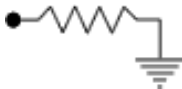

Note: The use of thermal mounting compound is recommended.

Electrical Specifications

Resistance Value:

10 - 1000 Ω or as required. Other values available upon request.

Frequency Range:

DC - .75 GHz

VSWR (Max.):

1.35:1

Standard Resistance Tolerance:

\pm 5% Other tolerances available upon request.

Part Dimensions

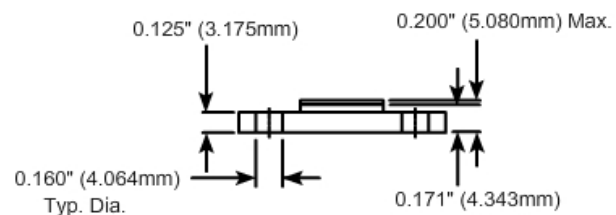
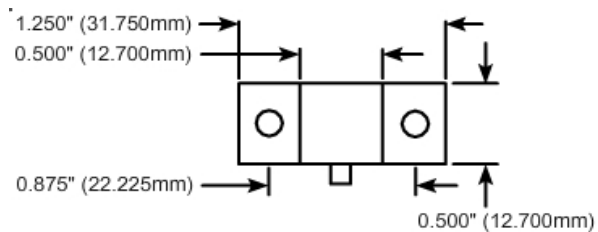

Component General, Inc.

P/N: CBT-400

Stripline Base Mounted Terminations

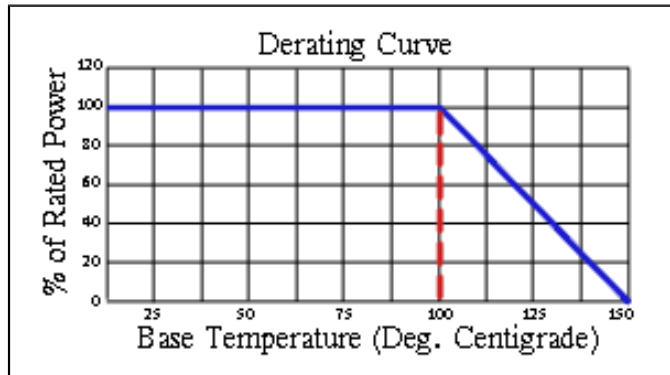

Mechanical Specifications

Covers:

Alumina Ceramic.

Substrate:

Beryllium Oxide Ceramic.

Contact:

Beryllium Copper, Gold Plated per MIL-G-45204.
Length: 0.250" Min., Width: 0.120",
Thickness 0.004" ± 0.002".

Heat Sink:

Copper, Nickel Plated per QQ-N-290.

Tolerance:

± 0.010" unless specified.

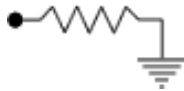

Note: The use of thermal mounting compound is recommended.

Electrical Specifications

Resistance Value:

10 - 1000 Ω or as required. Other values available upon request.

Frequency Range:

DC - .5 GHz
.5 - .75 GHz

VSWR (Max.):

1.25:1
1.35:1

Standard Resistance Tolerance:

± 5% Other tolerances available upon request.

Part Dimensions

