

STANDARD RECOVERY DIODES GEN II DO5

Stud Version

Features

- High surge current capability
- Designed for a wide range of applications
- Stud cathode and stud anode version
- Leaded version available/ wire version available
- Low thermal resistance
- UL approval pending

95 A

Typical Applications

- Battery charges
- Converters
- Power supplies
- Machine tool controls
- Welding

Major Ratings and Characteristics

Parameters	95PF (R)...(W)		Units
	40 to 120		
$I_{F(AV)}$		95	A
	@ T_C	140	°C
$I_{F(RMS)}$		149	A
I_{FSM}	@ 50Hz	2000	A
	@ 60Hz	2090	
I^2t	@ 50Hz	20000	A ² s
	@ 60Hz	18180	
V_{RRM}	range	400 to 1200	V
T_J	range	- 55 to 180	°C

95PF(R)...



case style DO-203AB (DO-5)

95PF(R)...W



case style DO-203AB (DO-5)

95PF(R)...(W) Series

Bulletin I20208 rev. C 03/04

International
IR Rectifier

ELECTRICAL SPECIFICATIONS

Voltage Ratings

Type number	Voltage Code	V_{RRM} maximum repetitive peak reverse voltage V	V_{RSM} maximum non-repetitive peak reverse voltage V	I_{RRM} max. @ $T_J = 150^\circ\text{C}$ mA
95PF (R)...(W)	40	400	500	9
	80	800	960	
	120	1200	1440	

Forward Conduction

Parameter	95PF(R)...(W)	Units	Conditions		
	40 to 120				
$I_{F(AV)}$ Max. average forward current @ Case temperature	95	A	180° conduction, half sine wave		
	140	°C			
$I_{F(RMS)}$ Max. RMS forward current	149	A			
I_{FSM} Max. peak, one-cycle forward, non-repetitive surge current	2000	A	t = 10ms	No voltage	Sinusoidal half wave, Initial $T_J = 150^\circ\text{C}$
	2090		t = 8.3 ms	reapplied	
	1680		t = 10ms	100% V_{RRM}	
	1760		t = 8.3 ms	reapplied	
I^2t Maximum I^2t for fusing	20000	A ² s	t = 10ms	No voltage	
	18180		t = 8.3ms	reapplied	
	14100		t = 10ms	100% V_{RRM}	
	12800		t = 8.3ms	reapplied	
$I^2\sqrt{t}$ Maximum $I^2\sqrt{t}$ for fusing	200000	A ² √s	t = 0.1 to 10ms, no voltage reapplied		
$V_{F(TO)}$ Low level value of threshold voltage	0.73	V	$(16.7\% \times \pi \times I_{F(AV)} < I < \pi \times I_{F(AV)})$, $T_J = T_J$ max.		
r_f Low level value of forward slope resistance	2.4	mΩ	$(16.7\% \times \pi \times I_{F(AV)} < I < \pi \times I_{F(AV)})$, $T_J = T_J$ max.		
V_{FM} Max. forward voltage drop	1.40	V	$I_{pk} = 267\text{A}$, $T_J = 25^\circ\text{C}$, $t_p = 400\mu\text{s}$ rectangular wave		

Thermal and Mechanical Specifications

Parameter	95PF (R)...(W)		Units	Conditions
		40 to 120		
T _J	Max. junction operating temperature range	-55 to 180	°C	
T _{stg}	Max. storage temperature range	-55 to 180		
R _{thJC}	Max. thermal resistance, junction to case	0.27	K/W	DC operation
R _{thCS}	Max. thermal resistance, case to heatsink	0.25		Mounting surface, smooth, flat and greased
T	Max. allowed mounting torque ±10%	2.3 + 3.4	Nm	Tighting on nut (1)
		20 + 30	lbf · in	
		3.2 + 4.3	Nm	Tighting on Hexagon (2)
		28 + 38	lbf · in	
wt	Approximate weight	15.8 (0.56)	g (oz)	
	Case style	DO-203AB (DO5)		See Outline Table

(1) As general recommendation we suggest to tight on Hexagon and not on nut

(2) Torque must be applicable only to Hexagon and not to plastic structure

ΔR_{thJC} Conduction

(The following table shows the increment of thermal resistance R_{thJC} when devices operate at different conduction angles than DC)

Conduction angle	Sinusoidal conduction	Rectangular conduction	Units	Conditions
180°	0.14	0.10	K/W	T _J = T _J max.
120°	0.16	0.17		
90°	0.21	0.22		
60°	0.30	0.31		
30°	0.50	0.50		

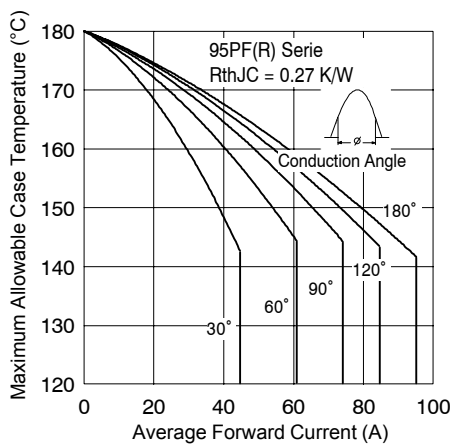

Fig. 1 - Current Ratings Characteristics

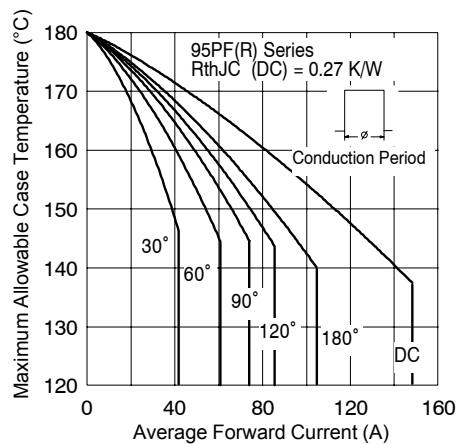

Fig. 2 - Current Ratings Characteristics

95PF(R)...(W) Series

Bulletin I20208 rev. C 03/04

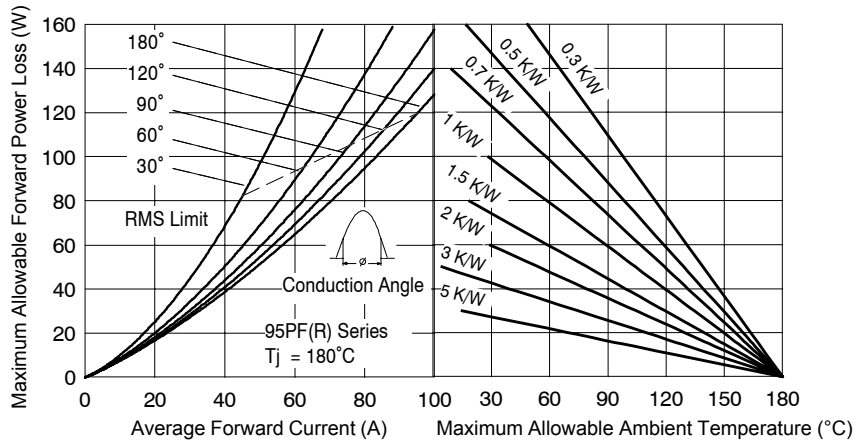

Fig. 3 - Forward Power Loss Characteristics

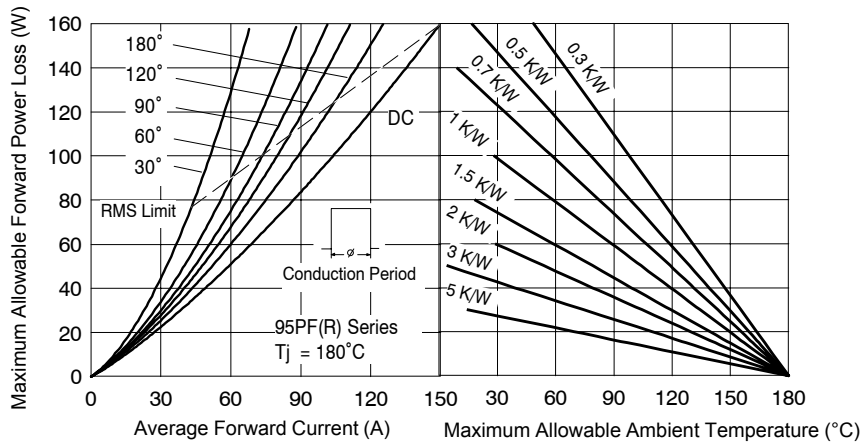

Fig. 4 - Forward Power Loss Characteristics

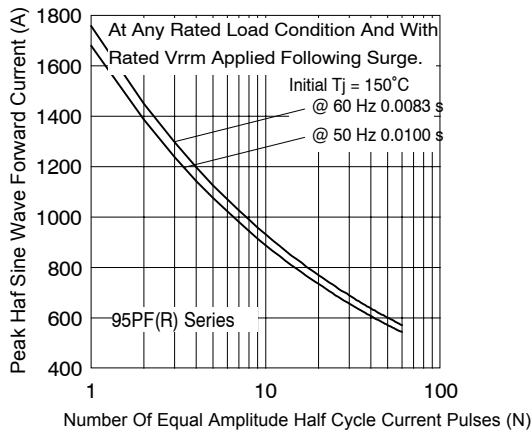

Fig. 5 - Maximum Non -Repetitive Surge Current

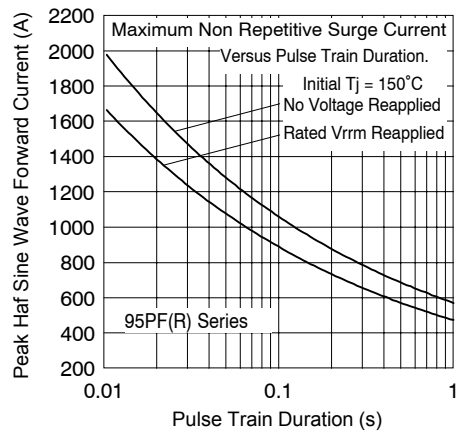

Fig. 6 - Maximum Non -Repetitive Surge Current

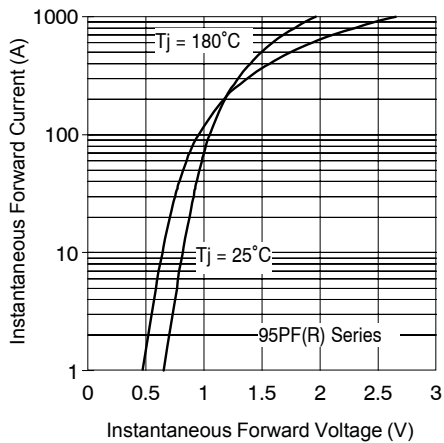

Fig. 7 - Forward Voltage Drop Characteristics

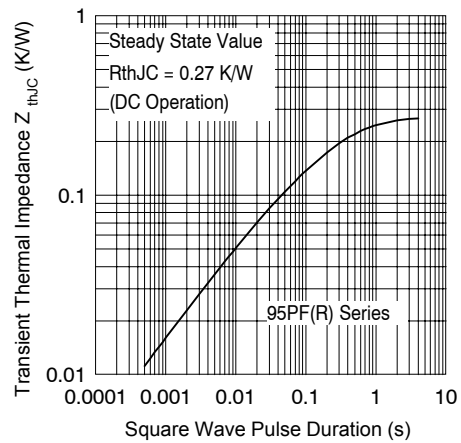
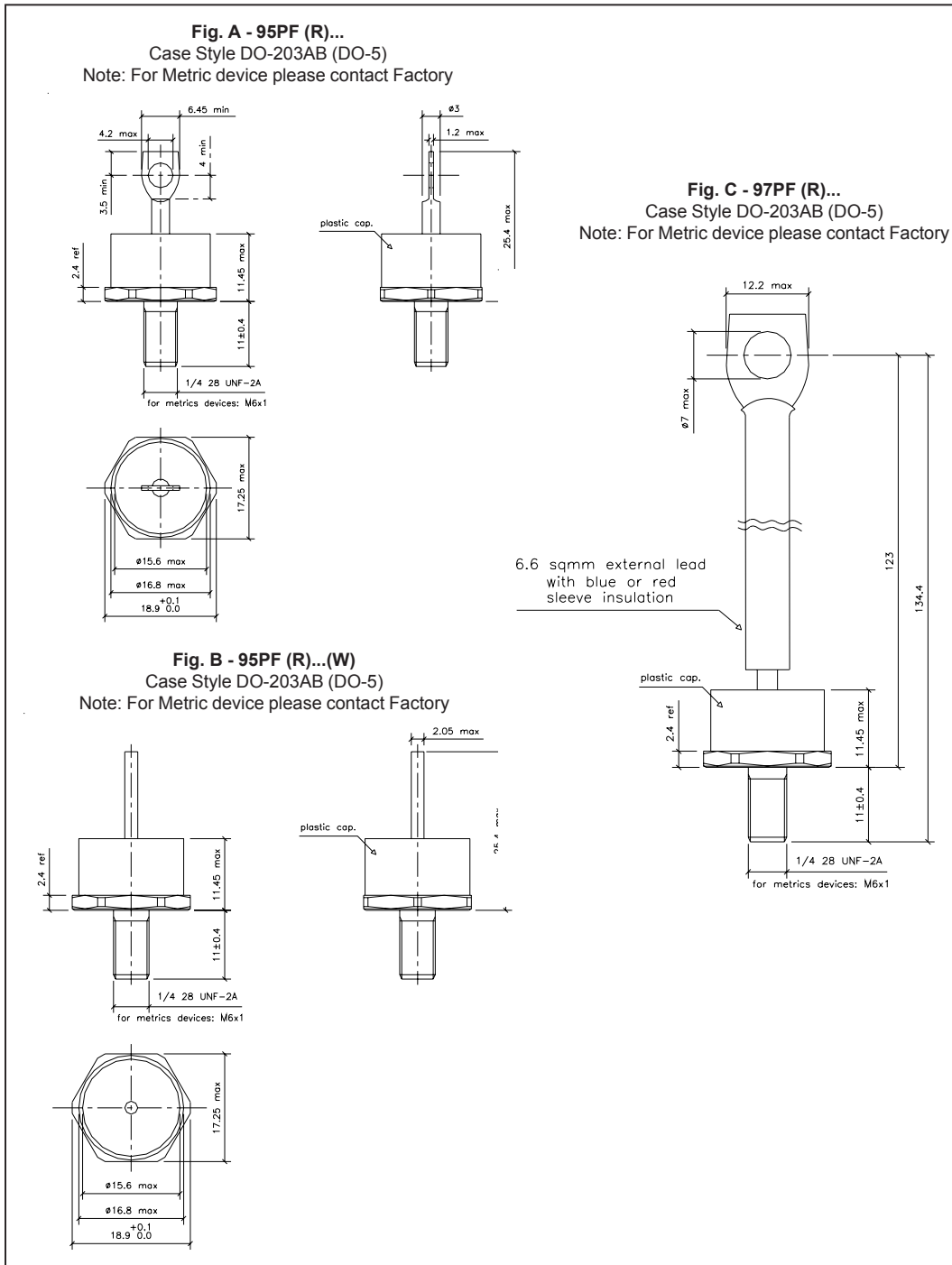

Fig. 8 - Thermal Impedance Z_{thJC} Characteristics

95PF(R)...(W) Series

Bulletin I20208 rev. C 03/04

Outline Table



Ordering Information Table

Device Code											
	<table border="1" style="margin: auto;"> <tr> <td style="padding: 5px;">95</td> <td style="padding: 5px;">PF</td> <td style="padding: 5px;">R</td> <td style="padding: 5px;">120</td> <td style="padding: 5px;">W</td> </tr> <tr> <td style="text-align: center;">1</td> <td style="text-align: center;">2</td> <td style="text-align: center;">3</td> <td style="text-align: center;">4</td> <td style="text-align: center;">5</td> </tr> </table>	95	PF	R	120	W	1	2	3	4	5
95	PF	R	120	W							
1	2	3	4	5							
<p>1 - 95 = Standard device 97 = Isolated lead on standard terminal with silicone sleeve available for 1200V only (Red = Reverse Polarity) (Blue = Normal Polarity)</p> <p>2 - PF = Plastic Package</p> <p>3 - None = Stud Normal Polarity (Cathode to Stud) R = Stud Reverse Polarity (Anode to Stud)</p> <p>4 - Voltage code: Code x 10 = V_{RRM} (See Voltage Ratings table)</p> <p>5 - None = Standard terminal (see Fig. A) - W = Wire terminal (see Fig. B)</p>											

Data and specifications subject to change without notice.
 This product has been designed and qualified for Multiple Level.
 Qualification Standards can be found on IR's Web site.