

UPB MODELS

Single Output High-Efficiency, Smaller-Package 25-40 Watt, DC/DC Converters

DATEL's new UPB Model, 25-40 Watt, single-output DC/DC power converters bring you efficient "on-board" power processing in a cost-effective smaller package with a standard pinout. The 2" x 3" UPB "footprint" conforms with the industry-standard pinout and pin geometries of most 3" x 3" devices (a 33% space savings) while delivering as much as 60% more power (40W vs. 25W).

Applicable to a wide range of telecom, computer and other OEM applications, UPB Model DC/DC's operate from four input voltage ranges (10-36V for "Q12" models, 18-36V for "D24" models, 18-72V for "Q48" models, and 36-72V for "D48" models). Available output voltages are 5, 12 and 15 Volts.

For improved reliability and affordability, DATEL exploits contemporary, high-speed, automatic-assembly techniques to construct the UPB's traditional, field-proven, SMT-on-pcb designs. Devices employ corrosion-resistant steel cases with heavy zinc top plates (traditionally referred to as baseplates). Heat generating transformer cores and power semiconductors are mounted directly to the baseplates, which also have threaded inserts for optional add-on heat sinks or pcb mounting. Temperature derating information is provided for operation with and without heat sinks and forced air flow.

All devices feature input pi filters, input undervoltage and overvoltage shutdown, output overvoltage protection, output current limiting, and thermal shutdown. All UPB models are UL1950, CSA 22.2 No. 950, and IEC950 approved. Most have been EMI/EMC characterized. Contact DATEL for the latest available information.

Features

- 25/30/35/40W output power
- Standard pinout! Smaller size!
- New 2" x 3" package fits 3" x 3" footprint
- 5V, 12V or 15V outputs
- Four input voltage ranges:
10-36V, 18-36V
18-72V, 36-72V
- High efficiencies (to 85%)
- Fully isolated, 750Vdc guaranteed
- Input under and overvoltage lockout
- Thermal shutdown
- VOUT trim and on/off control
- UL1950, CSA 22.2 No. 950, IEC950
- Modifications and customs for OEM's

Single Output

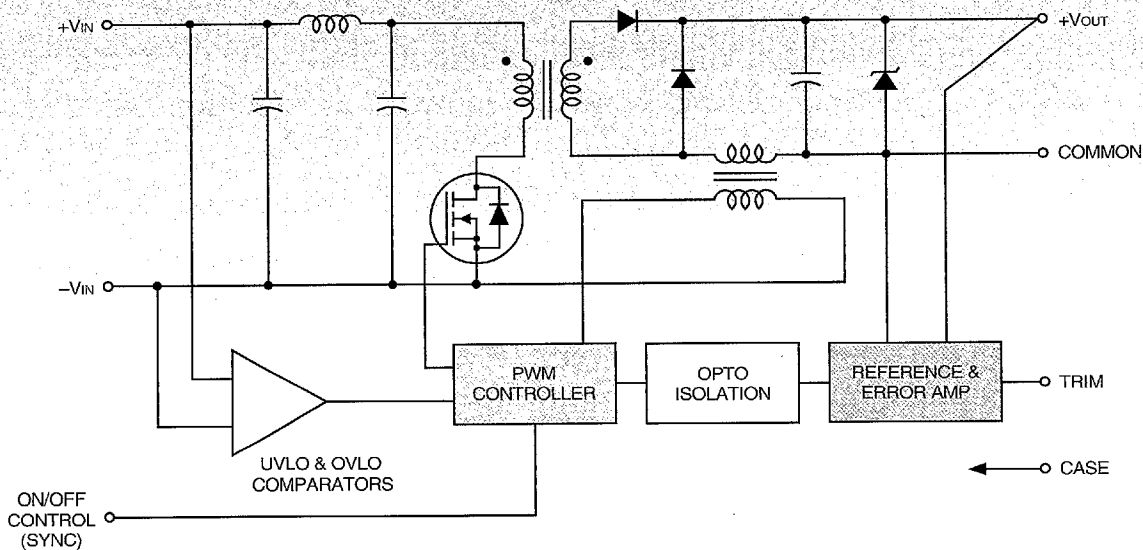

Figure 1. Simplified Schematic

Performance Specifications and Ordering Guide ①

Model	OUTPUT						INPUT			Efficiency		Package (Case, Pinout)
	V _{OUT} (Volts)	I _{OUT} (Amps)	R/N (mVp-p) ②		Regulation (Max.)		V _{IN} Nom. (Volts)	Range (Volts)	I _{IN} ④ (mA)	Min.	Typ.	
			Typ.	Max.	Line	Load ③						
UPB-5/5-Q12	5	5	75	100	±0.5%	±1%	24	10-36	50/1366	77%	79%	C10, P14
UPB-5/6-Q48	5	6	75	100	±0.5%	±1%	48	18-72	25/799	79%	80%	C10, P14
UPB-5/7-D24	5	7	75	100	±0.5%	±1%	24	18-36	25/1796	82%	83%	C10, P14
UPB-5/8-D48	5	8	75	100	±0.5%	±1%	48	36-72	25/1026	82%	85%	C10, P14
UPB-12/2.1-Q12	12	2.1	90	120	±0.5%	±1%	24	10-36	50/1326	81%	83%	C10, P14
UPB-12/2.5-Q48	12	2.5	90	120	±0.5%	±1%	48	18-72	30/761	83%	84%	C10, P14
UPB-12/3-D24	12	3	90	120	±0.5%	±1%	24	18-36	25/1825	83%	84%	C10, P14
UPB-12/3.3-D48	12	3.3	90	120	±0.5%	±1%	48	36-72	25/1004	83%	85%	C10, P14
UPB-15/1.7-Q12	15	1.7	100	150	±0.5%	±1%	24	10-36	50/1325	81%	83%	C10, P14
UPB-15/2-Q48	15	2	100	150	±0.5%	±1%	48	18-72	30/761	83%	84%	C10, P14
UPB-15/2.5-D24	15	2.5	100	150	±0.5%	±1%	24	18-36	25/1879	84%	85%	C10, P14
UPB-15/2.65-D48	15	2.65	100	150	±0.5%	±1%	48	36-72	25/1008	83%	85%	C10, P14

- ① Typical at T_A = +25°C under nominal line voltage and full-load conditions unless otherwise noted.
- ② Ripple/Noise (R/N) measured over a 20MHz bandwidth.
- ③ 10 to 100% load.
- ④ Nominal line voltage, no-load/full-load conditions.

Single Output

PART NUMBER STRUCTURE

U PB - 5 / 8 - D48

Output Configuration:
U = Unipolar

Power Package with
Metal Baseplate

Nominal Output Voltage:
5, 12 or 15 Volts

Input Voltage Range:
Q12 = 10-36 Volts (24V nominal)
D24 = 18-36 Volts (24V nominal)
Q48 = 18-72 Volts (48V nominal)
D48 = 36-72 Volts (48V nominal)

Maximum Output Current
in Amps

OUTPUT POWER CONSIDERATIONS

UPB DC/DC Converters are classified, by output power, into 25, 30, 35 and 40 Watt devices. For any given device, the maximum available output power is the product of the nominal output voltage and the maximum output current indicated within the part number. A UPB-5/6-Q48, for example, can source 6 Amps from its 5V output (over its entire 18-72V input range) delivering an output power of 30 Watts. A UPB-5/8-D48 can deliver 40 Watts.

Model	Maximum Output Power
"Q12"	25 Watts
"Q48"	30 Watts
"D24"	35 Watts
"D48"	40 Watts

MECHANICAL SPECIFICATIONS

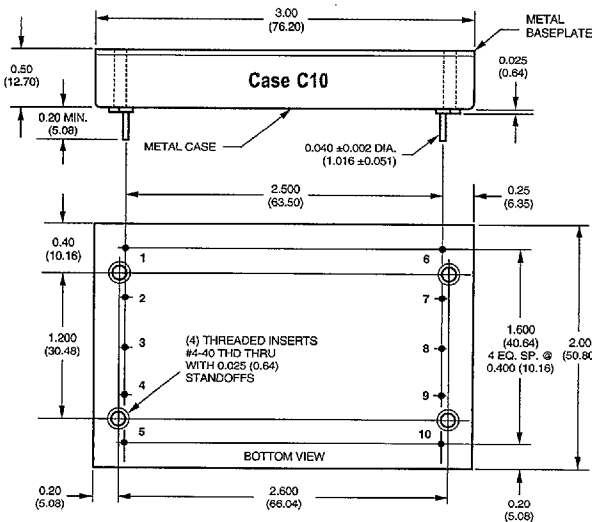

I/O Connections

Pin	Function P14
1	No Pin
2	-Input
3	+Input
4	Case
5	On/Off Control*
6	No Pin
7	No Pin
8	Common
9	+V _{OUT}
10	Trim

* See note 3 on next page.

Optional Heat Sink (Part Number HS-23)

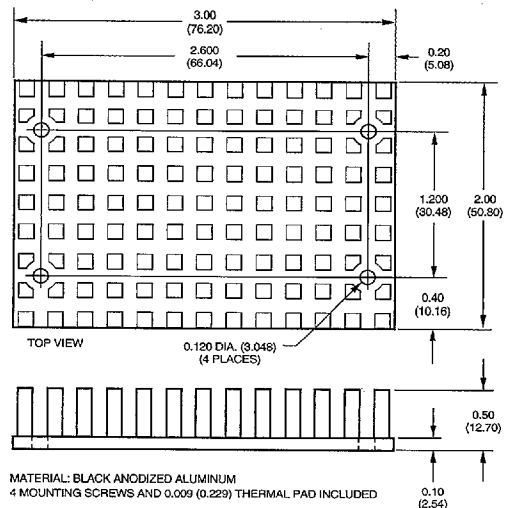

2651561 0004090 567

DATEL, Inc. 11 Cabot Boulevard, Mansfield, MA 02048-1151 (USA)

Tel: (508)339-3000, (800)233-2765 Fax: (508)339-6356 • Email: sales@datel.com • Internet: www.datel.com

Performance/Functional Specifications

Typical @ T_A = +25°C under nominal line voltage and full-load conditions, unless noted. ①

INPUT	
Input Voltage Range:	
"Q12" Models	10-36 Volts (24V nominal)
"D24" Models	18-36 Volts (24V nominal)
"Q48" Models	18-72 Volts (48V nominal)
"D48" Models	36-72 Volts (48V nominal)
Undervoltage Lockout:	
"Q12" Models	9 Volts
"D24" Models	17 Volts
"Q48" Models	17 Volts
"D48" Models	34 Volts
Input Current	See Ordering Guide
Input Filter Type ②	Pi
Overvoltage Shutdown:	
"D24" and "Q12" Models	40 Volts
"D48" and "Q48" Models	80 Volts
Reverse-Polarity Protection	Yes (Instantaneous, 6A maximum)
On/Off Control (Pin 5) ③	TTL high (or open) = on, low = off
OUTPUT	
V_{out} Accuracy (50% load)	±1%, maximum
Temperature Coefficient	±0.04% per °C
Ripple/Noise (20MHz BW) ②	See Ordering Guide
Line/Load Regulation	See Ordering Guide
Efficiency	See Ordering Guide
Isolation Voltage	750Vdc, minimum
Isolation Capacitance	700pF
Current Limiting	Continuous, auto-recovery
Overvoltage Protection	Zener/transorb clamp, magnetic feedback
DYNAMIC CHARACTERISTICS	
Transient Response (50% load step)	200µsec max. to ±1.5% of final value
Switching Frequency	165kHz (±10%)
ENVIRONMENTAL	
Operating Temperature (Ambient):	
Without Derating	-25 to +50°C (Model dependent)
With Derating	to +100°C (See Derating Curves)
Maximum Baseplate Temperature	+100°C
Storage Temperature	-40 to +105°C
PHYSICAL	
Dimensions	2" x 3" x 0.5" (50.8 x 76.2 x 12.7mm)
Shielding	6-sided
Case Connection	Pin 4
Case Material	Tin-plated steel
Baseplate Material	Zinc with black enamel finish
Pin Material	Brass, solder coated
Weight	4 ounces (113 grams)

① These converters require a minimum 10% output loading to maintain specified regulation. Operation under no-load conditions will not damage these devices; however they may not meet all listed specifications.

② Application-specific input/output filtering can be recommended or perhaps added internally upon request. Contact DATEL Applications Engineering for details.

③ Applying a voltage to the Control pin when no input power is applied to the converter can cause permanent damage to the converter. If desired, the On/Off function can be replaced with a Sync function. See page 6 of this data sheet for more details.

ABSOLUTE MAXIMUM RATINGS

Input Voltage:	
"Q12/D24" Models	44 Volts
"Q48/D48" Models	88 Volts
Input Reverse-Polarity Protection	Current must be <6A. Brief duration only. Fusing recommended.
Output Overvoltage Protection:	
5V Outputs	6.8 Volts, limited duration
12V Outputs	15 Volts, limited duration
15V Outputs	18 Volts, limited duration
Output Current	Current limited. Max. current and short-circuit duration are model dependent.
Storage Temperature	-40 to +105°C
Lead Temperature (soldering, 10 sec.)	+300°C

These are stress ratings. Exposure of devices to any of these conditions may adversely affect long-term reliability. Proper operation under conditions other than those listed in the Performance/Functional Specifications Table is not implied.

TECHNICAL NOTES

Floating Outputs

Since these are isolated DC/DC converters, their outputs are "floating." Users may ground either the Common (pin 8) for normal usage or the positive side (+Output, pin 9) to effectively reverse the output polarity.

Filtering and Noise Reduction

All UPB 25-40 Watt DC/DC Converters achieve their rated ripple and noise specifications without the use of external input/output capacitors. In critical applications, input/output ripple and noise may be further reduced by installing electrolytic capacitors across the input terminals and/or low-ESR tantalum or electrolytic capacitors across the output terminals. The caps should be located as close to the power converters as possible. Typical values are listed in the tables below. In many applications, using values greater than those listed will yield better results.

To Reduce Input Ripple

"Q12, D24" Models	47µF, 50V
"Q48, D48" Models	10µF, 100V

To Reduce Output Ripple

5V Outputs	47µF, 10V, Low ESR
12/15V Outputs	22µF, 20V, Low ESR

In critical, space-sensitive applications, DATEL may be able to tailor the internal input/output filtering of these devices to meet your specific requirements. Contact our Applications Engineering Group for additional details.

Input Fusing

Certain applications and/or safety agencies may require the installation of fuses at the inputs of power conversion components. For DATEL UPB DC/DC Converters, you should use slow-blow type fuses with values no greater than the following:

V _{IN} Range	Fuse Value
"Q12"	4A
"D24"	4A
"Q48"	3A
"D48"	2A

Temperature Derating and Electrical Performance Curves

Q12 Models (25 Watts)

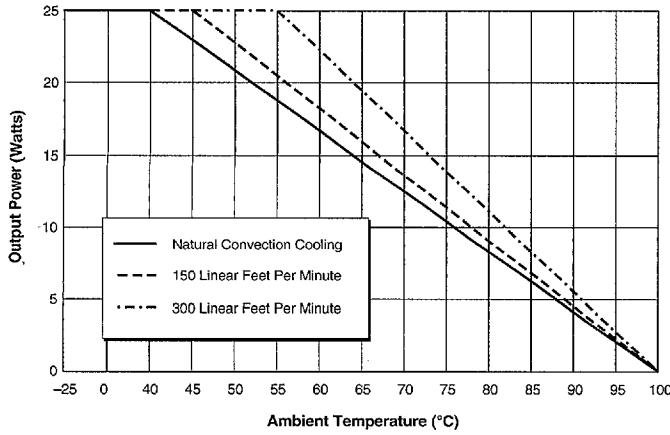

Figure 2a. Temperature Derating Without Heat Sink

Q48 Models (30 Watts)

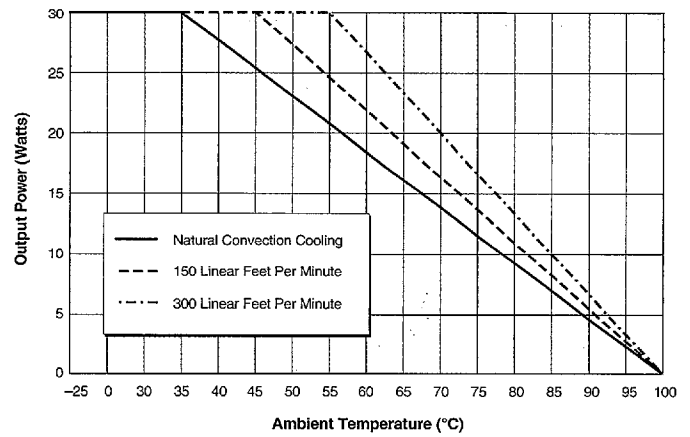

Figure 3a. Temperature Derating Without Heat Sink

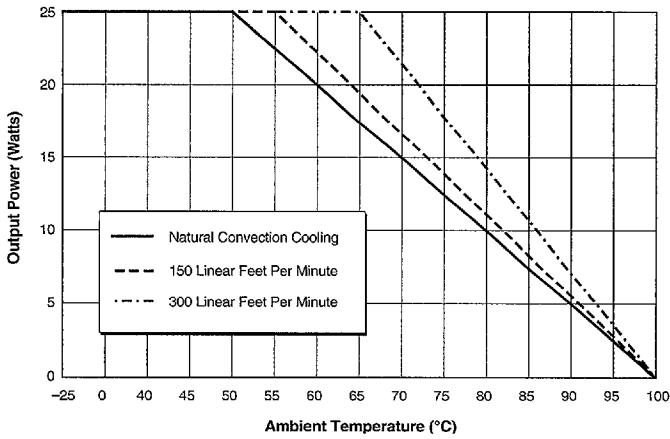

Figure 2b. Temperature Derating With Heat Sink

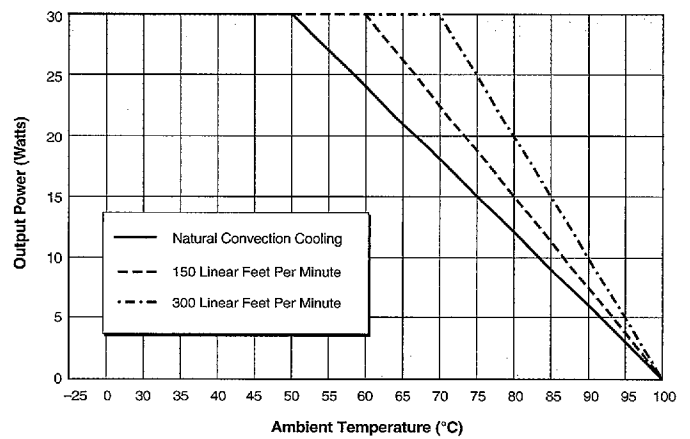

Figure 3b. Temperature Derating With Heat Sink

Model UPB-5/5-Q12

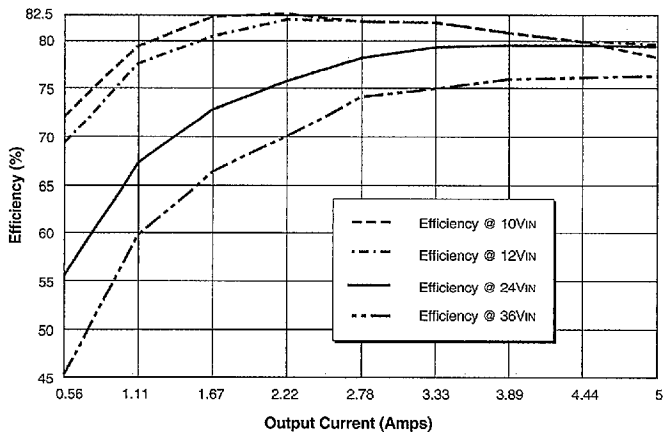

Figure 2c. Efficiency vs. Output Current and Input Voltage

Model UPB-5/6-Q48

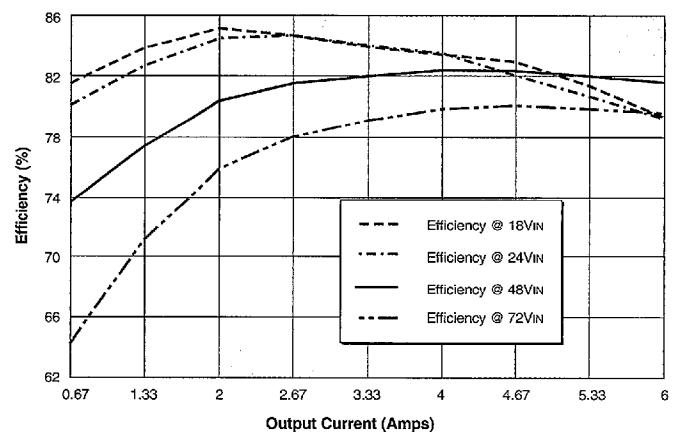

Figure 3c. Efficiency vs. Output Current and Input Voltage

2651561 0004092 33T

DATEL, Inc. 11 Cabot Boulevard, Mansfield, MA 02048-1151 (USA)

Tel: (508)339-3000, (800)233-2765 Fax: (508)339-6356 • Email: sales@datel.com • Internet: www.datel.com

Temperature Derating and Electrical Performance Curves

D24 Models (35 Watts)

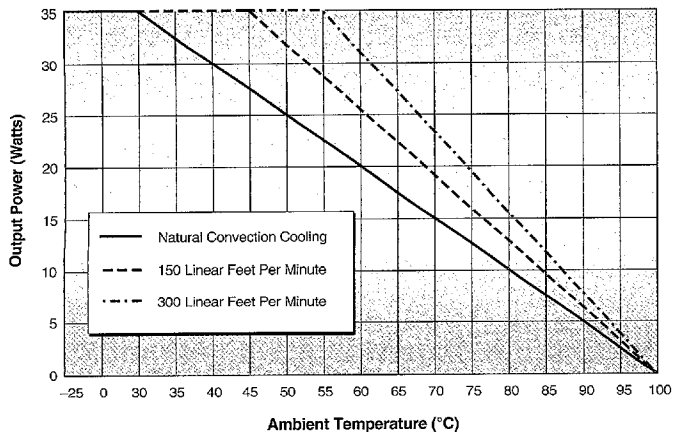

Figure 4a. Temperature Derating Without Heat Sink

D48 Models (40 Watts)

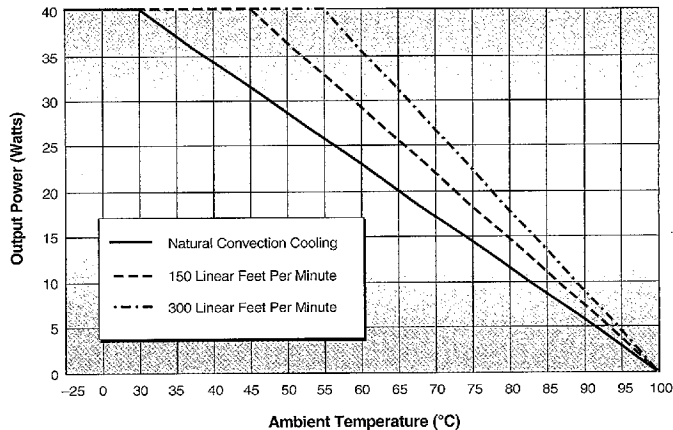

Figure 5a. Temperature Derating Without Heat Sink

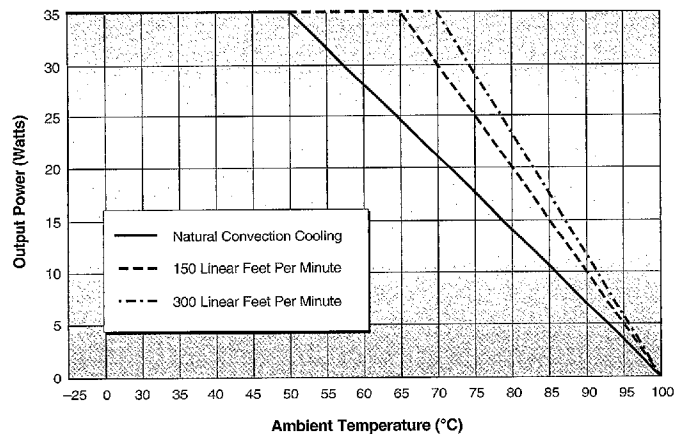

Figure 4b. Temperature Derating With Heat Sink

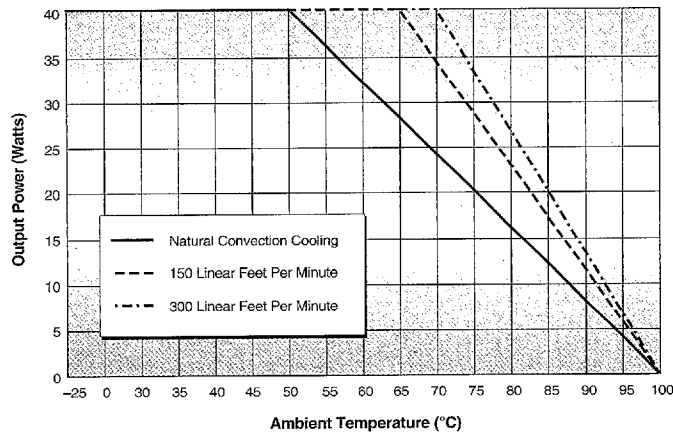

Figure 5b. Temperature Derating With Heat Sink

Model UPB-5/7-D24

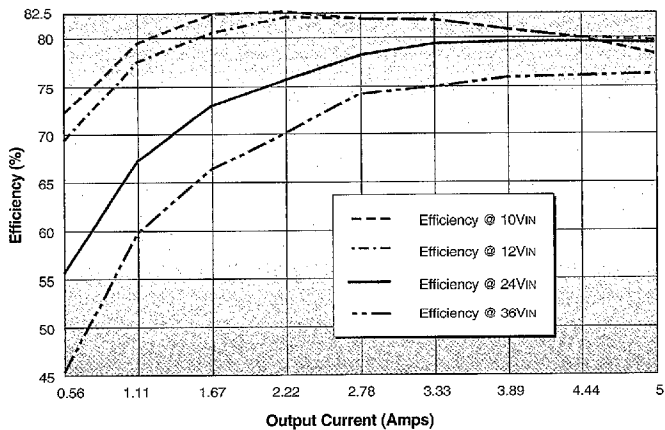

Figure 4c. Efficiency vs. Output Current and Input Voltage

Model UPB-5/8-D48

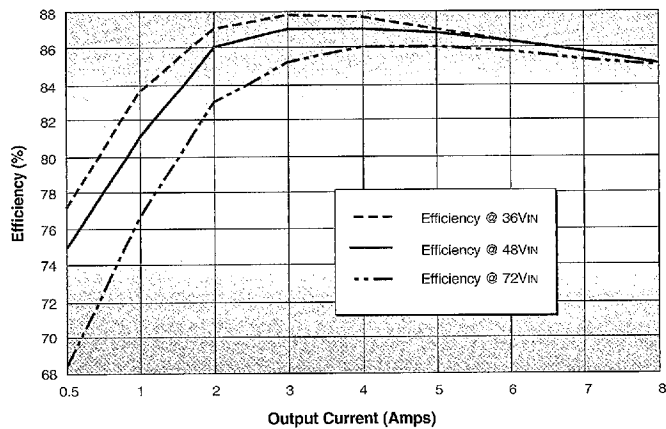

Figure 5c. Efficiency vs. Output Current and Input Voltage

Single Output

On/Off Control (Standard)

The On/Off Control pin (pin 5) may be used for remote on/off operation. As shown in Figure 6, the control pin has an internal 10kΩ pull-up resistor to approximately 10V. The converter is designed so that it is enabled when the control pin is left open (normal mode) and disabled when the control pin is pulled low (to less than +0.8V relative to -Input, pin 2).

Dynamic control of the on/off function is best accomplished with a mechanical relay or an open-collector/open-drain drive circuit (optically isolated if appropriate). The drive circuit should obviously be able to sink approximately 1mA when activated and withstand more than 10 Volts when deactivated.

Applying an external voltage to pin 5 when no input power is applied to the converter can cause permanent damage to the converter. The on/off control function, however, is designed such that the converter can be disabled (pin 5 pulled low) while input power is ramping up and then "released" once the input has stabilized. Under these circumstances, it takes approximately 30ms for the output of the fully loaded DC/DC to ramp up and settle to within ±1% of its final value after the converter has been turned on.

Synchronization (Optional)

In critical applications employing multiple switching DC/DC converters, it may be desirable to intentionally synchronize the switching of selected converters (so the system noise can be reduced with notch filtering) or to purposely desynchronize the converters (to lessen the current-carrying requirements on intermediate dc buses). UPB DC/DC Converters have been designed so that the On/Off Control function on pin 5 can be replaced with a Sync function. This change has to be implemented by DATEL during the product assembly process. Contact our Applications Engineering Group for additional details.

To synchronize the switching of multiple UPB converters configured with the Sync function, an external clock can be applied to pin 5 of each converter. The clock should be a TTL square wave referenced to -Input (logic high = +2 to +5 Volts, 250μA max.; logic low = 0 to +0.8 Volts, 70μA max.) with a maximum 1μsec "high" duration. The frequency of the synchronizing clock should be higher than that of any individual converter. Therefore, it should be 185kHz ±5kHz.

Output Trimming

V_{OUT} may be trimmed ±5% via a single trimpot or fixed resistor. The trimpot should be connected between +Output (pin 9) and Common (pin 8) with its wiper connected to pin 10 (Trim). A trimpot can also be used to determine the value of a single fixed resistor which can be connected between pin 10 (Trim) and pin 9 (+Output) to trim "down" the output voltages, or between pins 10 (Trim) and 6 (-Output) to trim "up" the output voltages. Fixed resistors should be metal-film types with absolute TCR's less than 100ppm/°C to ensure stability.

Case Connection

Unlike most other DC/DC converters, UPB DC/DC's do not have their metal case connected to one of their input pins. The "uncommitted" case is connected to pin 4 which, depending on your system configuration, should be connected to either +Input (pin 3), -Input (pin 2), Common (pin 8), or earth ground.

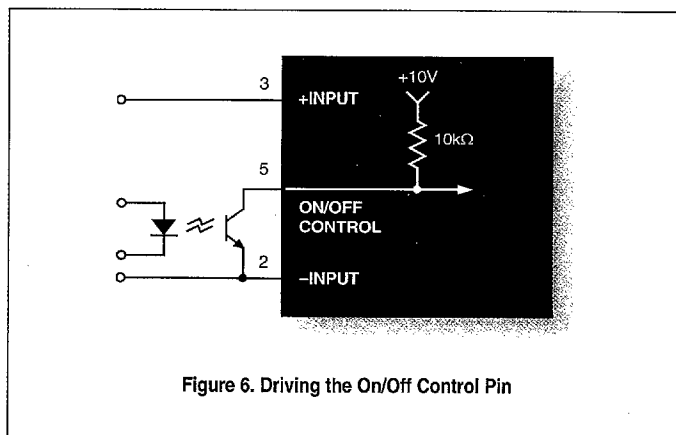
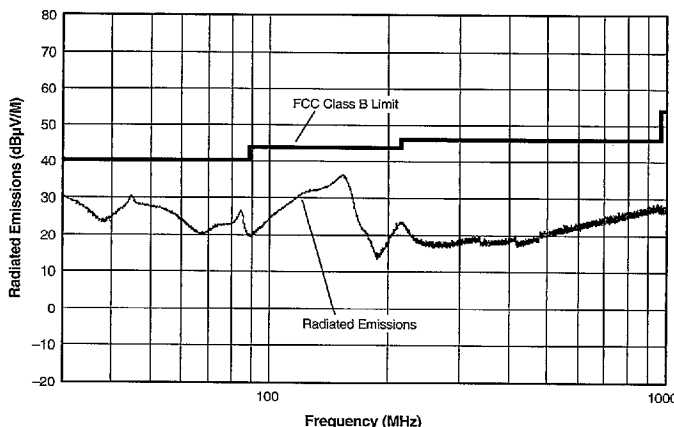

Figure 6. Driving the On/Off Control Pin

EMI RADIATED EMISSIONS

Radiated emissions plots to FCC and CISPR 22 for model UPB-5/8-D48 appear below. Published EMC test reports are available for each model. Contact DATEL's Applications Engineering Department for more details.

**UPB-5/8-D48 Radiated Emissions
FCC Part 15 Class B, 3 Meters
Converter Output = +5Vdc @ +6.45 Amps**



**UPB-5/8-D48 Radiated Emissions
EN 55022 Class B, 10 Meters
Converter Output = +5Vdc @ +6.45 Amps**

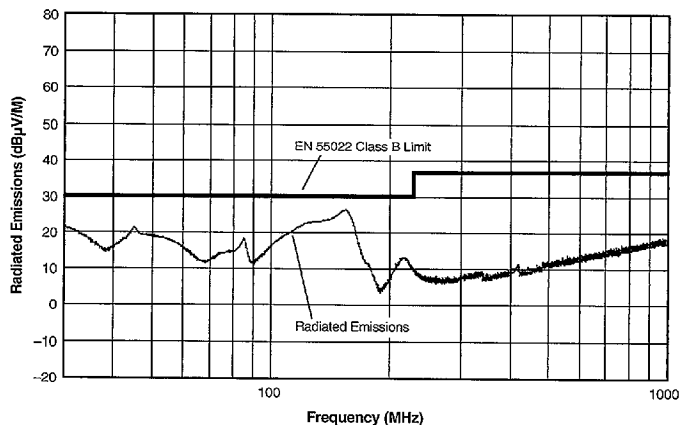

2651561 0004094 102

DATEL, Inc. 11 Cabot Boulevard, Mansfield, MA 02048-1151 (USA)

Tel: (508)339-3000, (800)233-2765 Fax: (508)339-6356 • Email: sales@datel.com • Internet: www.datel.com