

M16C/26A Group

Sample Program (Electronic Desktop Calculator)

1. Summary

This sample program provides the functionality of an electronic desktop calculator by using the Renesas Starter Kit for M16C/26A (R0K33026AS000BE) and an extension board.

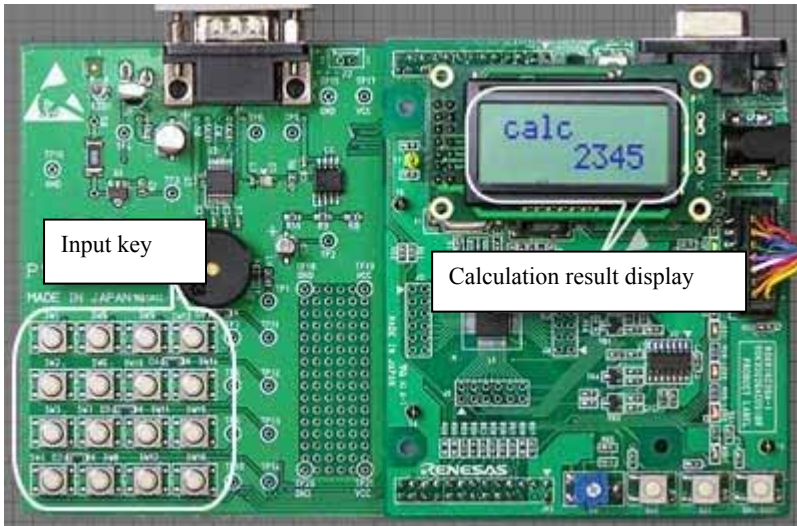

The extension board used here is a product from PI System Co., Ltd.

2. Introduction

The example described in this document applies to the microcomputers listed below:

Microcomputers: M16C26A

This sample program runs on the Renesas Starter Kit for M16C/26A (R0K33026AS000BE).

Prepare an extension board available for the Renesas Starter Kit or create a circuit similar to the one shown in the circuit diagram on page 15 and then connect it to the Starter Kit.

This program uses RSK_LIB. For details about RSK_LIB, see the RSK_LIB reference manual. (RSK_LIB is the library software provided for use with the Renesas Starter Kit for M16C/26A.)

3. Port Arrangement

The key matrix and the buzzer are the facilities mounted on an extension board for the Renesas Starter Kit. To use these facilities, connect an extension board to the Starter Kit.

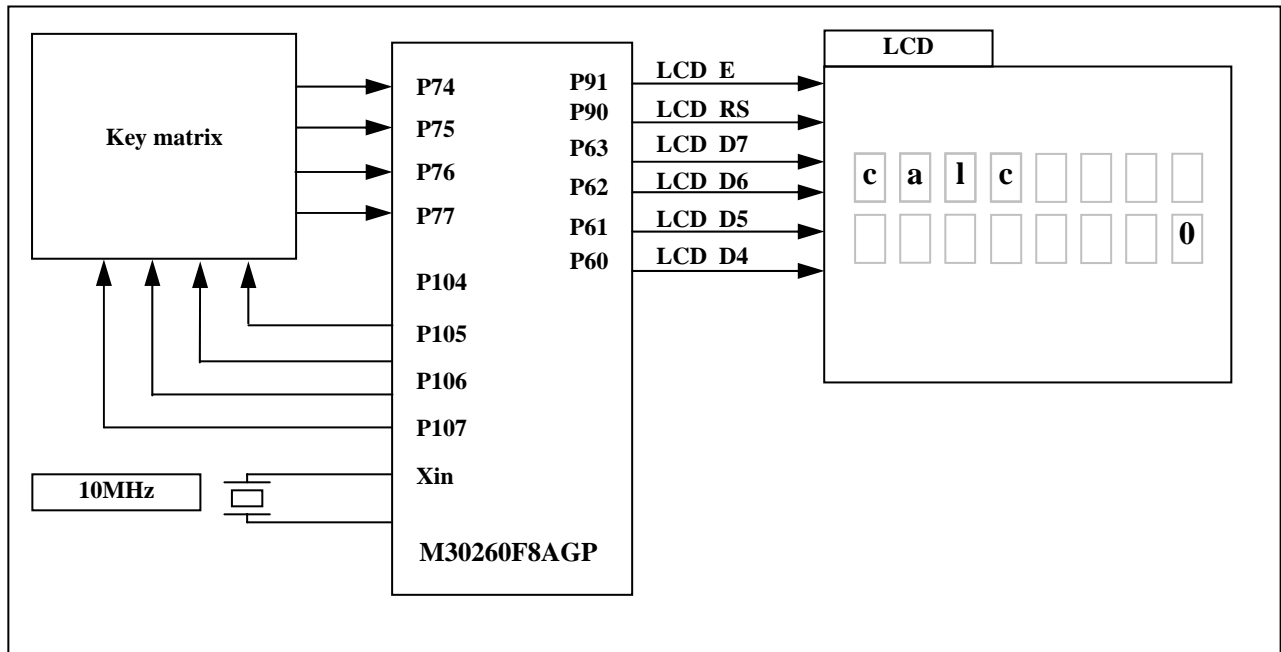

4. Operational Outline

Calculation results are shown on liquid crystal display.

The display shows the result of operation when calculation results are within 7 digits (from -9999999 to 9999999) or “E” when calculation results are equal to or more than 8 digits. For example, when you enter “1234 5678 =,” the display will show “6912.” Or when you enter “1234567 8901234,” the display will show “E.”

When a key is depressed, the buzzer sounds.

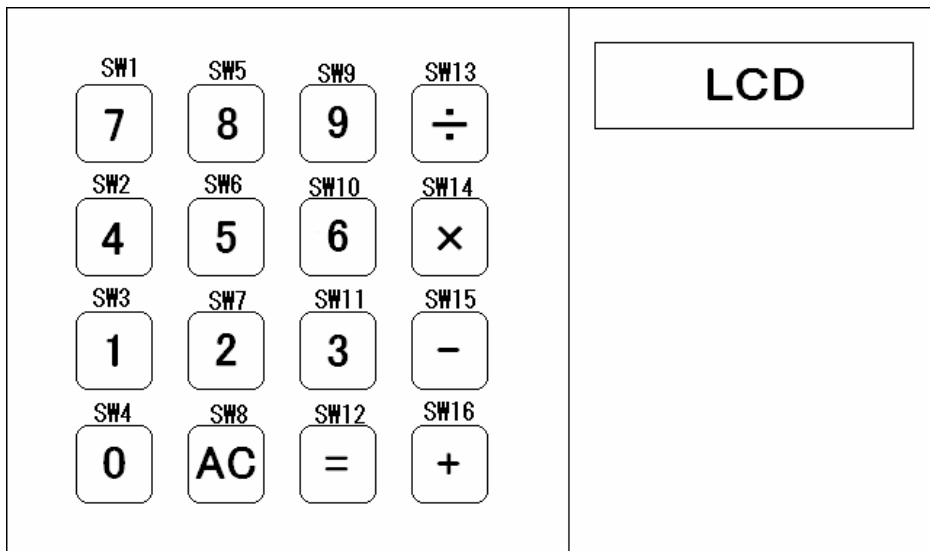

Note: In this program, pressing two or more switches at the same time has no effect (i.e., ignored).

This function is materialized using the following microcomputer facilities:

- Timer A0 (timer mode, main 2 ms cycle)

This timer counts 2 milliseconds using the main clock of the microcomputer as the count source.

It is used as the basic timer of RSK_LIB.

Time management, key scan, and LCD display management are performed using this timer.

- Timer A1 (pulse modulation mode, buzzer output)

This timer outputs a waveform with different high and low pulse widths using the main clock of the microcomputer as the count source.

It is used to sound a buzzer each time a key is touched.

5. Operational Specification

Example for $1 \times 20 = 21$

(1) The display shows the string "calc" and the numeral "0" immediately after the reset switch is pressed.

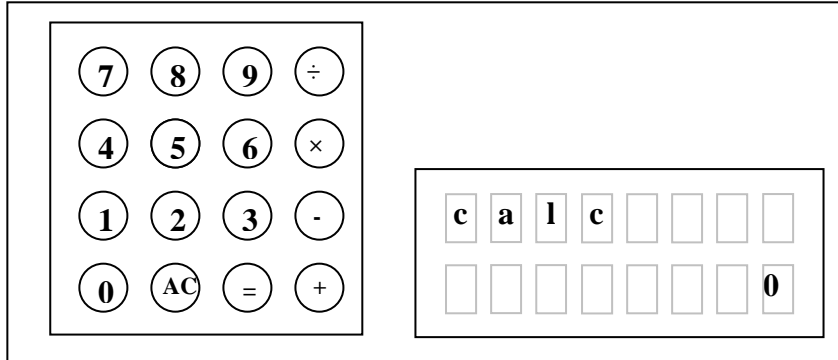

(2) The "1" key is entered.

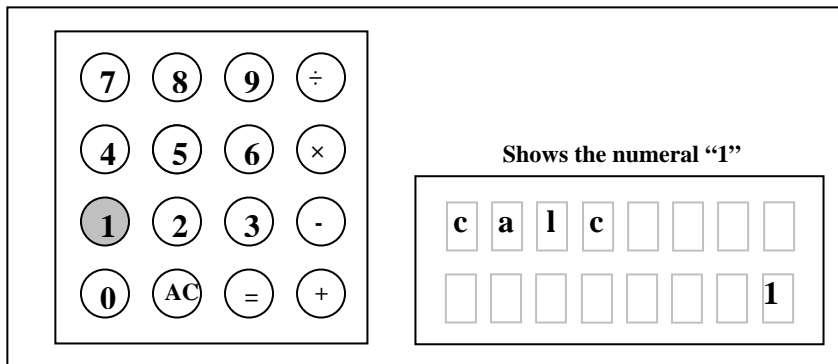

(3) The "." key is entered.

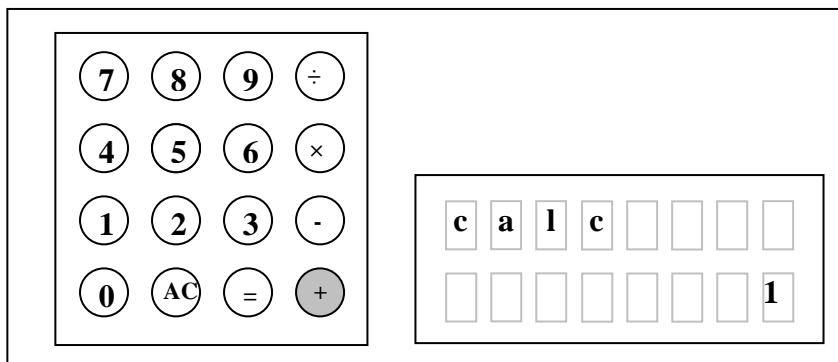

(4) The "2" key is entered.

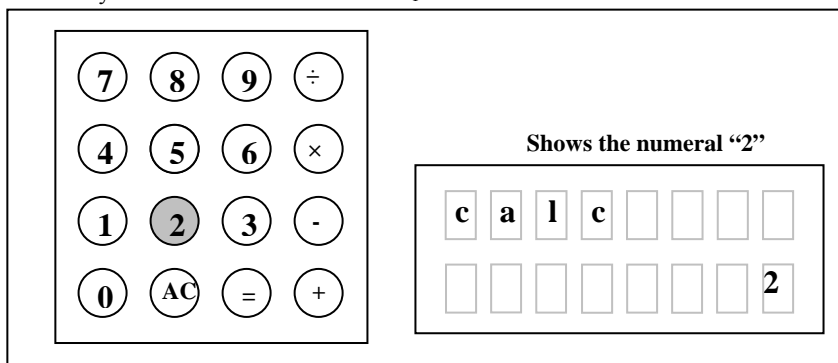

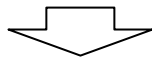

(5) The "0" key is entered.

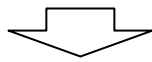
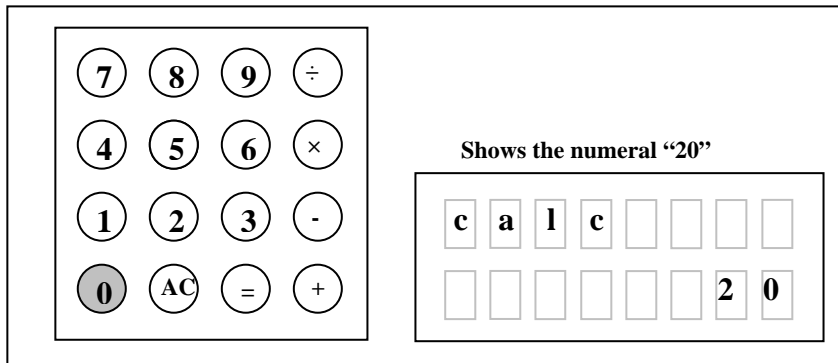

(6) The "=" key is entered.

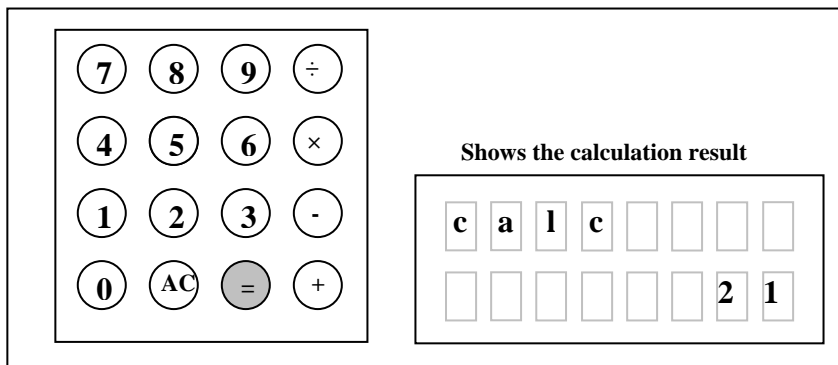

(7) The "AC" key is entered.

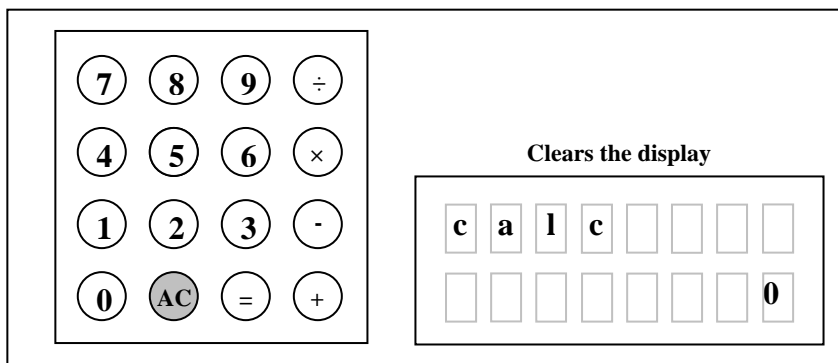

6. Definition of the RSK Functionality and the RSK_LIB APIs and Common Functions Used by the Calculator

6.1 Definition of the RSK Functionality

RSKdefine.h file

In this application, the following functionalities (those shown in red) are set.

```

/*****
    The boot information on CPU is defined
    Usually, this mode is used
    *****/
#define _CPU_M16C26A_NORMAL_MOD
/* Use in low power mode can be performed. */
//#define _CPU_M16C26A_32KHZ_MOD
/* Use of access of a flash can be performed. */
//#define _CPU_M16C26A_DATAFLASF_USE

/*****
    The hardware function which RSK supports is chosen
    *****/
#define _USE_KEY
#define _USE_BUZZER
//#define _OPTION_USE_AD
//#define _OPTION_USE_COM_RX
//#define _OPTION_USE_COM_TX
//#define _OPTION_USE_INFRAEDRX
//#define _OPTION_USE_INFRAEDTX
//#define _OPTION_USE_SW
//#define _OPTION_USE_LED
//#define _OPTION_USE_IO
    
```

Individual definition of each selected functionality.

```

#if defined _USE_KEY
/* A key matrix continues pushing and existence is defined.*/
/*When not using -USE_KEY_CONTINU is made a comment.*/
//#define _USE_KEY_CONTINU
#if defined _USE_KEY_CONTINU
    
    Continuous key depression is not used in
    this application.

#else
#define _CONTINU_SW1 _KEY_CONTEINU_OFF
#define _CONTINU_SW2 _KEY_CONTEINU_OFF
#define _CONTINU_SW3 _KEY_CONTEINU_OFF
#define _CONTINU_SW4 _KEY_CONTEINU_OFF
#define _CONTINU_SW5 _KEY_CONTEINU_OFF
#define _CONTINU_SW6 _KEY_CONTEINU_OFF
#define _CONTINU_SW7 _KEY_CONTEINU_OFF
#define _CONTINU_SW8 _KEY_CONTEINU_OFF
#define _CONTINU_SW9 _KEY_CONTEINU_OFF
#define _CONTINU_SW10 _KEY_CONTEINU_OFF
#define _CONTINU_SW11 _KEY_CONTEINU_OFF
#define _CONTINU_SW12 _KEY_CONTEINU_OFF
#define _CONTINU_SW13 _KEY_CONTEINU_OFF
#define _CONTINU_SW14 _KEY_CONTEINU_OFF
#define _CONTINU_SW15 _KEY_CONTEINU_OFF
#define _CONTINU_SW16 _KEY_CONTEINU_OFF
#endif
    
```

6.2 APIs and Common Functions Used

```
ApiStatusType RL_SefTimerReq( unsigned int TimerValue, char TimerMode, int *TimerNo, int *ERcode );
ApiStatusType RL_StartTimer( int TimerNo, int *ERcode );
ApiStatusType RL_CheckTimer( int TimerNo, int *ERcode );
ApiStatusType RL_Get_Key( int *Inkey, int *ERcode );
ApiStatusType RL_Start_Buzzer( char freqNo, int *ERcode );
ApiStatusType RL_Stop_Buzzer( int *ERcode );
ApiStatusType RL_Putc_Lcd( char Ylocation, char outc, int *ERcode );
ApiStatusType RL_Puts_LcdLoc( char Xlocation, char Ylocation, char RvTime, const char far* outc, int
                             *ERcode );
void RL_LengthCpy( char *Dest, char far *Strm, char Len );
void RL_ErrorHook( int FuncNo, int ErrorNo );
```

For details about the APIs and common functions used by the sample program (electronic desktop calculator), see the Renesas Starter Kit Library V.1.00 Reference Manual.

7. Flowchart

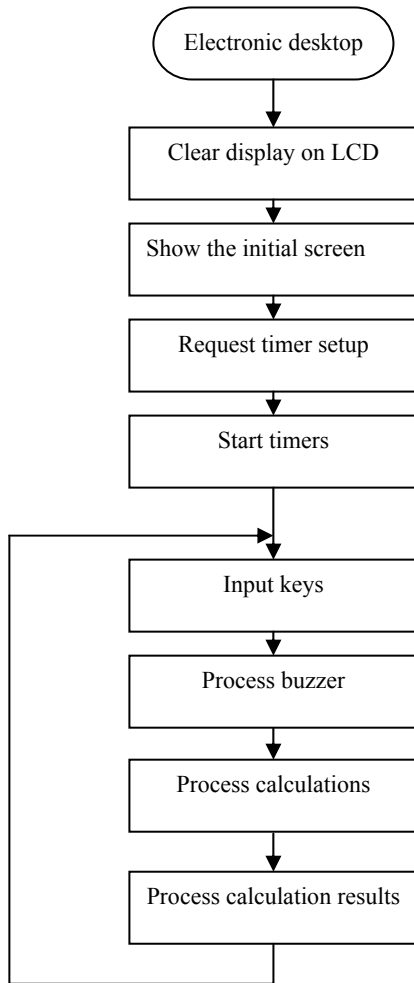

8. Tutorial

- 1 Launch the HEW by double-clicking its icon.



Calculator.hws

- 2 Change the session name from “default Session” to “SessionM16C_E8_System.”

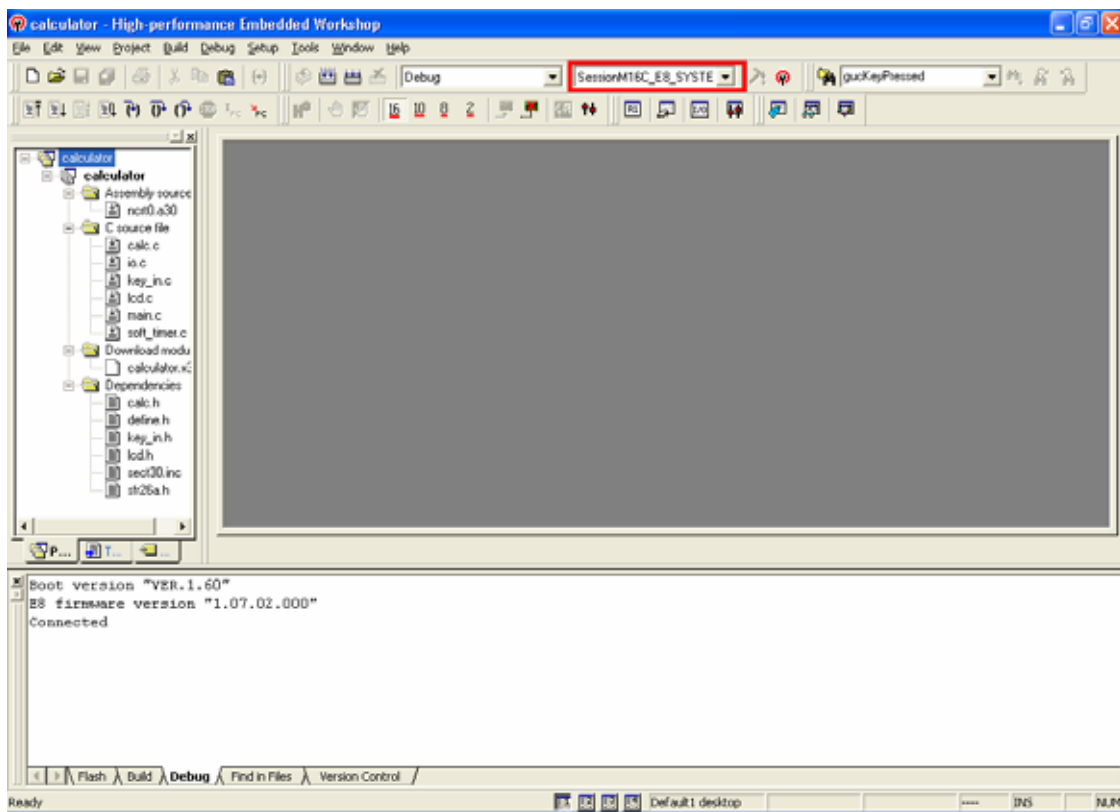

- 3 Select "M30260F8A" for Device.
Select "Download emulator firmware" for Mode.

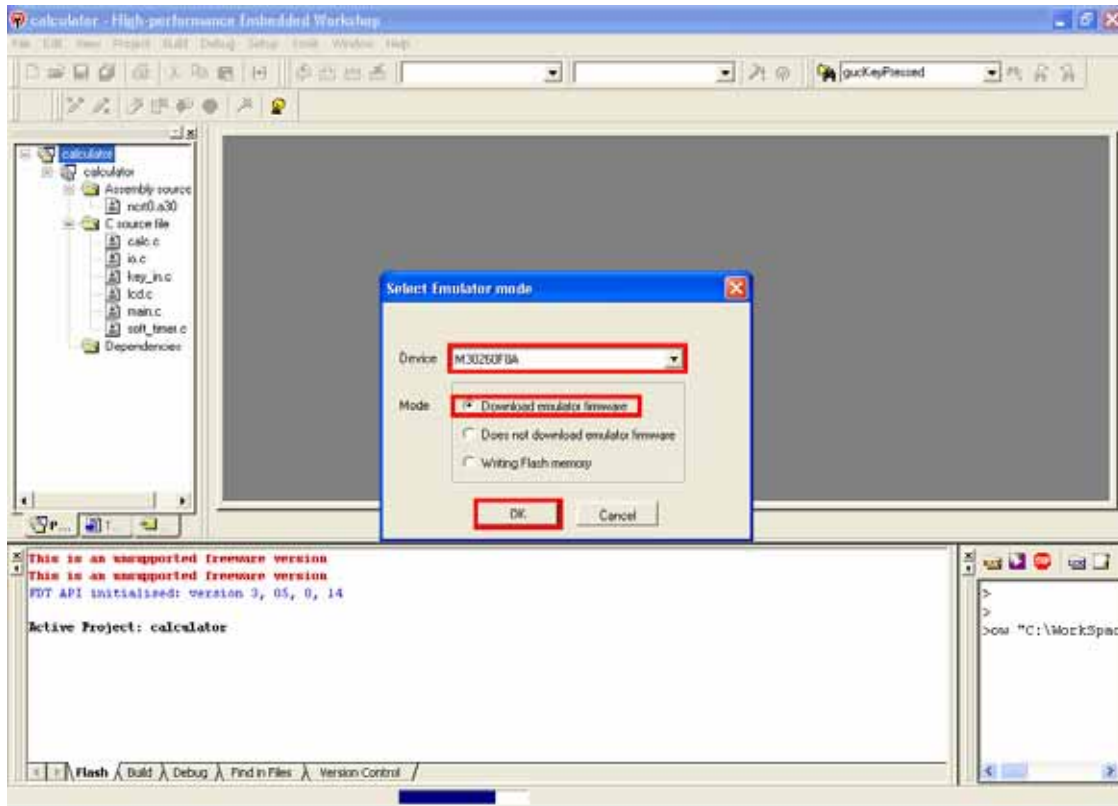

Check the box labeled “Power supply is carried out. (MAX 300mA)” and then select “5.0V.”

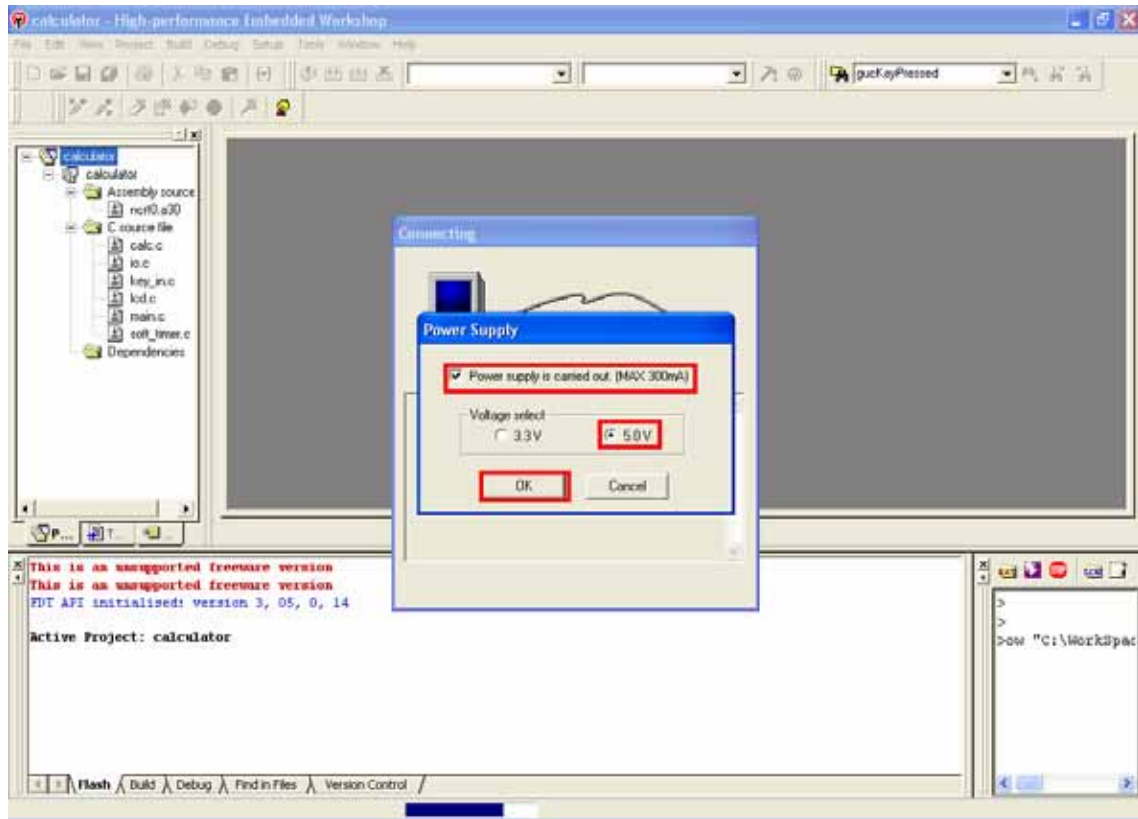

- In the program and the work RAM text boxes of Firmware Location & WDT, enter “FA0” and “0B8” respectively. Leave the box labeled “Debug a program using the WDT” unchecked.

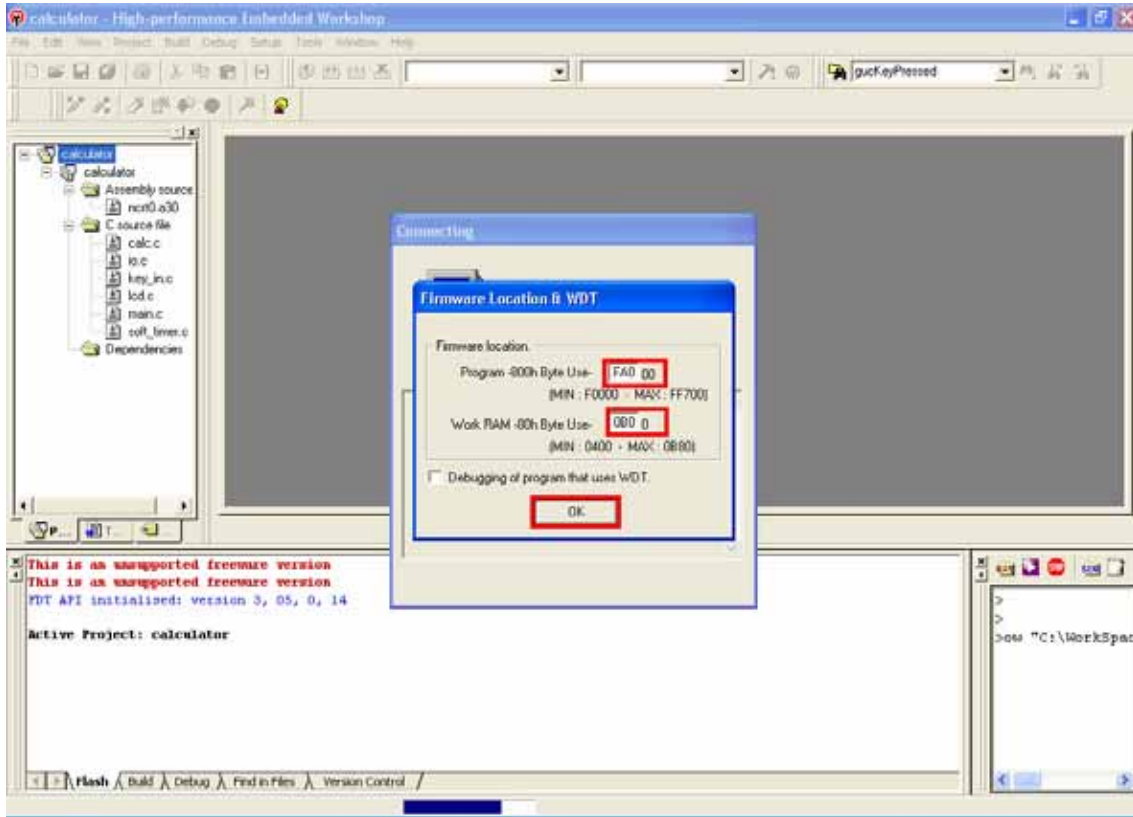

- 5 Choose Download from the Debug tab and download a module.
The upper-side choices for Download show the location from which a project was downloaded.

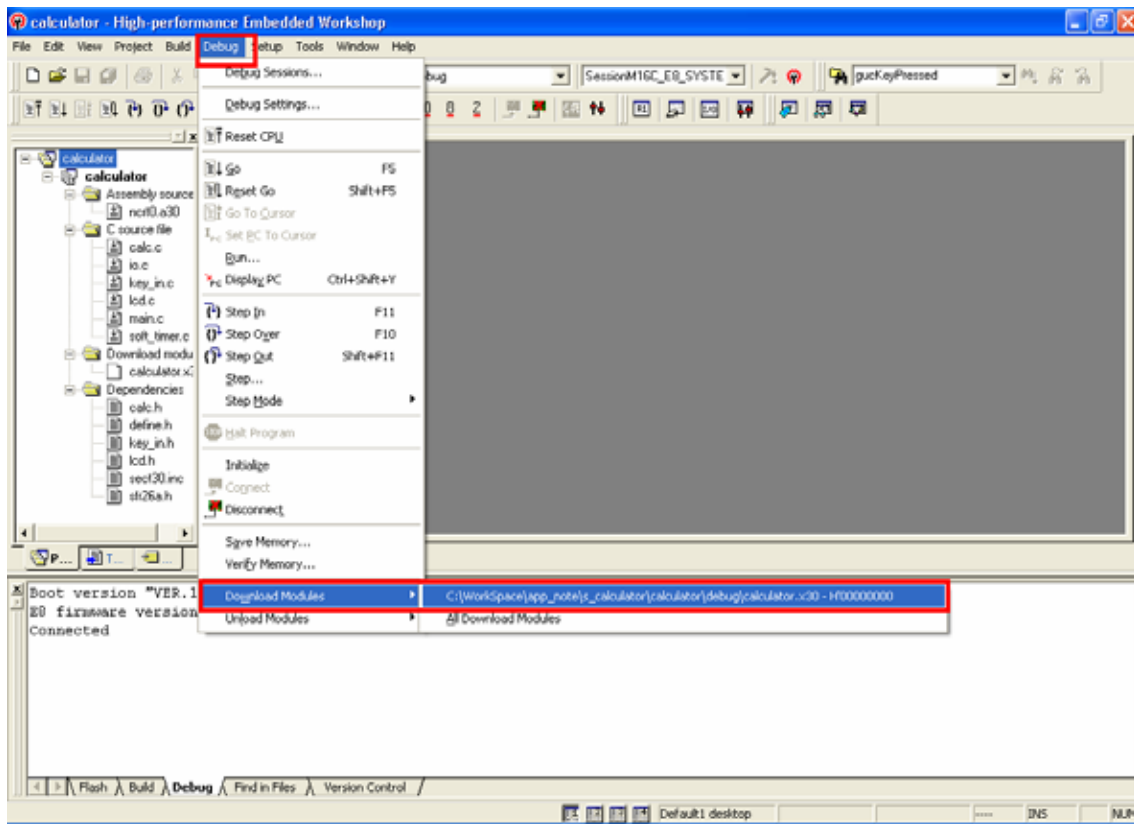

- Click "Start after Reset" to start program execution.

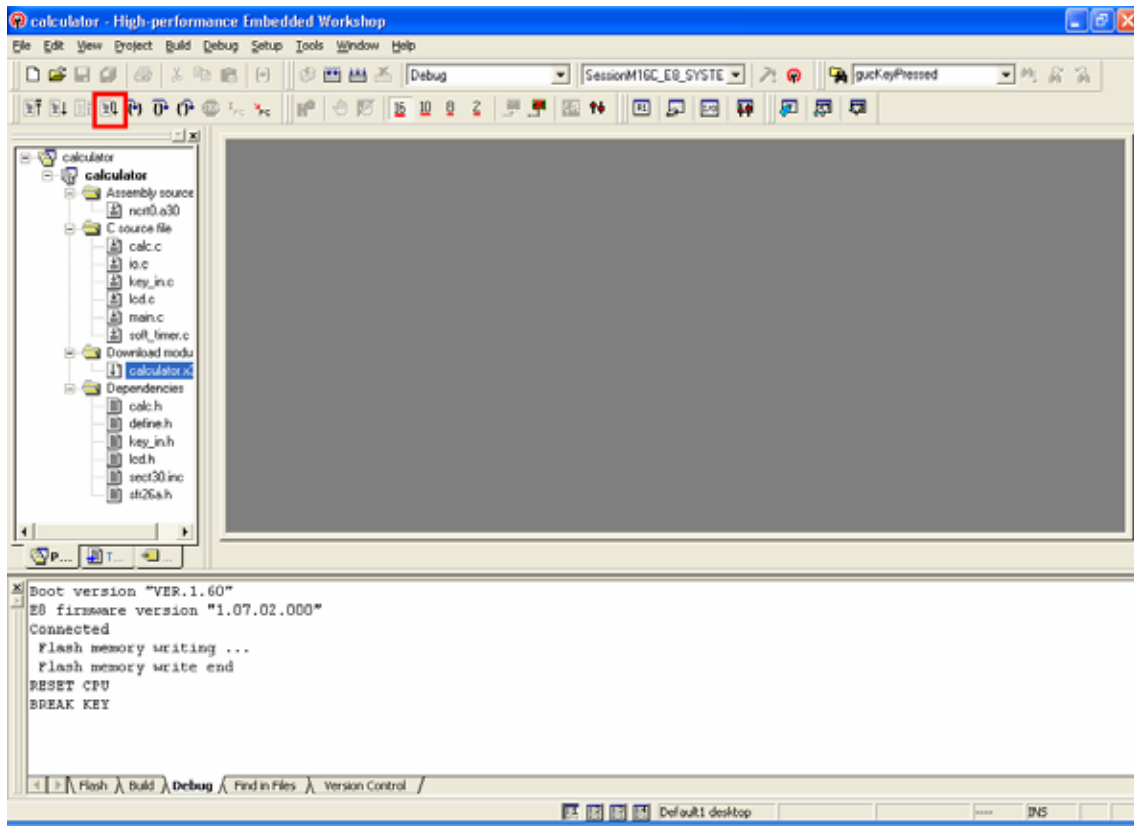

- Please do "Cancellation" when "The file is opened" window opens.

9. Circuit Diagram

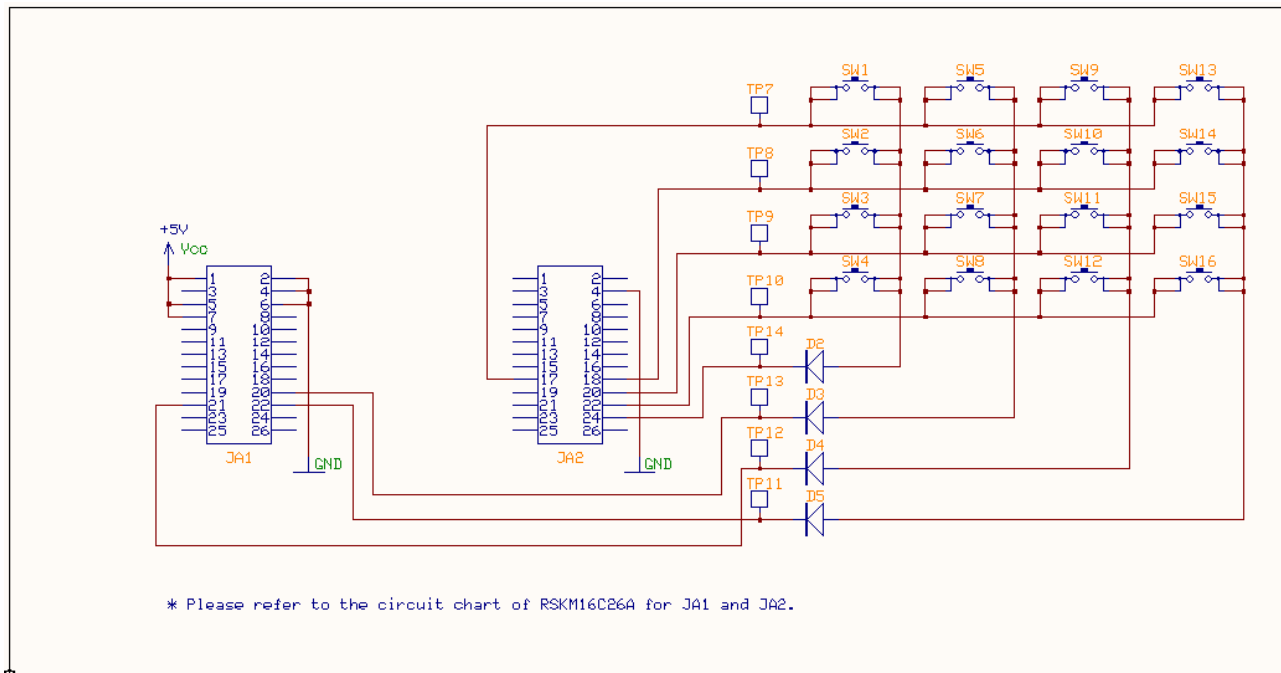

10. Part List

Part name	Part No.	Q'ty	Manufacturer	Type number	Value	Remark
Tact switch	SW1 -SW16	16	OMRON	B3FS-1000P		
Switching diode	D2 - D5	4	ROHM	1SS355TE-17		
PCB header	JA1,JA2	2	Molex	10-88-1261	26-pin	Male, 2-row, vertical type

11. Web Sitet

Renesas Technology Web site

<http://www.renesas.com/>

Revision History

Rev.	Date of issue	Content of revision	
		Page	Points
1.00	2006.06.30	-	First revision issued
1.10	2007.07.12	-	Contents of presentation improved
1.20	2007.11.29	-	RSK_LIB APIs supported

Notes regarding these materials

1. This document is provided for reference purposes only so that Renesas customers may select the appropriate Renesas products for their use. Renesas neither makes warranties or representations with respect to the accuracy or completeness of the information contained in this document nor grants any license to any intellectual property rights or any other rights of Renesas or any third party with respect to the information in this document.
2. Renesas shall have no liability for damages or infringement of any intellectual property or other rights arising out of the use of any information in this document, including, but not limited to, product data, diagrams, charts, programs, algorithms, and application circuit examples.
3. You should not use the products or the technology described in this document for the purpose of military applications such as the development of weapons of mass destruction or for the purpose of any other military use. When exporting the products or technology described herein, you should follow the applicable export control laws and regulations, and procedures required by such laws and regulations.
4. All information included in this document such as product data, diagrams, charts, programs, algorithms, and application circuit examples, is current as of the date this document is issued. Such information, however, is subject to change without any prior notice. Before purchasing or using any Renesas products listed in this document, please confirm the latest product information with a Renesas sales office. Also, please pay regular and careful attention to additional and different information to be disclosed by Renesas such as that disclosed through our website. (<http://www.renesas.com>)
5. Renesas has used reasonable care in compiling the information included in this document, but Renesas assumes no liability whatsoever for any damages incurred as a result of errors or omissions in the information included in this document.
6. When using or otherwise relying on the information in this document, you should evaluate the information in light of the total system before deciding about the applicability of such information to the intended application. Renesas makes no representations, warranties or guaranties regarding the suitability of its products for any particular application and specifically disclaims any liability arising out of the application and use of the information in this document or Renesas products.
7. With the exception of products specified by Renesas as suitable for automobile applications, Renesas products are not designed, manufactured or tested for applications or otherwise in systems the failure or malfunction of which may cause a direct threat to human life or create a risk of human injury or which require especially high quality and reliability such as safety systems, or equipment or systems for transportation and traffic, healthcare, combustion control, aerospace and aeronautics, nuclear power, or undersea communication transmission. If you are considering the use of our products for such purposes, please contact a Renesas sales office beforehand. Renesas shall have no liability for damages arising out of the uses set forth above.
8. Notwithstanding the preceding paragraph, you should not use Renesas products for the purposes listed below:
 - (1) artificial life support devices or systems
 - (2) surgical implantations
 - (3) healthcare intervention (e.g., excision, administration of medication, etc.)
 - (4) any other purposes that pose a direct threat to human life
 Renesas shall have no liability for damages arising out of the uses set forth in the above and purchasers who elect to use Renesas products in any of the foregoing applications shall indemnify and hold harmless Renesas Technology Corp., its affiliated companies and their officers, directors, and employees against any and all damages arising out of such applications.
9. You should use the products described herein within the range specified by Renesas, especially with respect to the maximum rating, operating supply voltage range, movement power voltage range, heat radiation characteristics, installation and other product characteristics. Renesas shall have no liability for malfunctions or damages arising out of the use of Renesas products beyond such specified ranges.
10. Although Renesas endeavors to improve the quality and reliability of its products, IC products have specific characteristics such as the occurrence of failure at a certain rate and malfunctions under certain use conditions. Please be sure to implement safety measures to guard against the possibility of physical injury, and injury or damage caused by fire in the event of the failure of a Renesas product, such as safety design for hardware and software including but not limited to redundancy, fire control and malfunction prevention, appropriate treatment for aging degradation or any other applicable measures. Among others, since the evaluation of microcomputer software alone is very difficult, please evaluate the safety of the final products or system manufactured by you.
11. In case Renesas products listed in this document are detached from the products to which the Renesas products are attached or affixed, the risk of accident such as swallowing by infants and small children is very high. You should implement safety measures so that Renesas products may not be easily detached from your products. Renesas shall have no liability for damages arising out of such detachment.
12. This document may not be reproduced or duplicated, in any form, in whole or in part, without prior written approval from Renesas.
13. Please contact a Renesas sales office if you have any questions regarding the information contained in this document, Renesas semiconductor products, or if you have any other inquiries.