

SKiiP 23NAB126V1



MiniSKiiP[®] 2

3-phase bridge rectifier +
brake chopper + 3-phase
bridge inverter
SKiiP 23NAB126V1

Features

- Fast Trench IGBTs
- Robust and soft freewheeling diodes in CAL technology
- Highly reliable spring contacts for electrical connections
- UL recognised file no. E63532

Typical Applications

- Inverter up to 16 kVA
- Typical motor power 7,5 kW

Remarks

- V_{CEsat} , V_F = chip level value

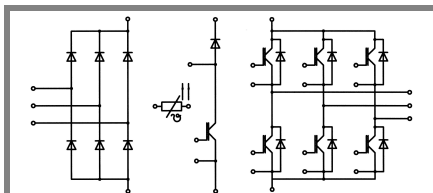

NAB

| Absolute Maximum Ratings | | $T_s = 25\text{ }^\circ\text{C}$, unless otherwise specified | |
|----------------------------------|--|---|----------------------|
| Symbol | Conditions | Values | Units |
| IGBT - Inverter, Chopper | | | |
| V_{CES} | | 1200 | V |
| I_C | $T_s = 25\text{ (70) }^\circ\text{C}$ | 41 (31) | A |
| I_{CRM} | $t_p \leq 1\text{ ms}$ | 50 | A |
| V_{GES} | | ± 20 | V |
| T_j | | - 40 ... + 150 | $^\circ\text{C}$ |
| Diode - Inverter, Chopper | | | |
| I_F | $T_s = 25\text{ (70) }^\circ\text{C}$ | 30 (22) | A |
| I_{FRM} | $t_p \leq 1\text{ ms}$ | 50 | A |
| T_j | | - 40 ... + 150 | $^\circ\text{C}$ |
| Diode - Rectifier | | | |
| V_{RRM} | | 1600 | V |
| I_F | $T_s = 70\text{ }^\circ\text{C}$ | 46 | A |
| I_{FSM} | $t_p = 10\text{ ms, sin } 180^\circ, T_j = 25\text{ }^\circ\text{C}$ | 370 | A |
| i^2t | $t_p = 10\text{ ms, sin } 180^\circ, T_j = 25\text{ }^\circ\text{C}$ | 680 | A^2s |
| T_j | | - 40 ... + 150 | $^\circ\text{C}$ |
| I_{tRMS} | per power terminal (20 A / spring) | 40 | A |
| T_{stg} | $T_{op} \leq T_{stg}$ | - 40 ... + 125 | $^\circ\text{C}$ |
| V_{isol} | AC, 1 min. | 2500 | V |

| Characteristics | | $T_s = 25\text{ }^\circ\text{C}$, unless otherwise specified | | | |
|----------------------------------|---|---|------------|-----------|------------------|
| Symbol | Conditions | min. | typ. | max. | Units |
| IGBT - Inverter, Chopper | | | | | |
| V_{CEsat} | $I_{Cnom} = 25\text{ A, } T_j = 25\text{ (125) }^\circ\text{C}$ | | 1,7 (2) | 2,1 (2,4) | V |
| $V_{GE(th)}$ | $V_{GE} = V_{CE}, I_C = 1\text{ mA}$ | 5 | 5,8 | 6,5 | V |
| $V_{CE(TO)}$ | $T_j = 25\text{ (125) }^\circ\text{C}$ | | 1 (0,9) | 1,2 (1,1) | V |
| r_T | $T_j = 25\text{ (125) }^\circ\text{C}$ | | 28 (44) | 36 (52) | $\text{m}\Omega$ |
| C_{ies} | $V_{CE} = 25\text{ V, } V_{GE} = 0\text{ V, } f = 1\text{ MHz}$ | | 1,8 | | nF |
| C_{oes} | $V_{CE} = 25\text{ V, } V_{GE} = 0\text{ V, } f = 1\text{ MHz}$ | | 0,3 | | nF |
| C_{res} | $V_{CE} = 25\text{ V, } V_{GE} = 0\text{ V, } f = 1\text{ MHz}$ | | 0,2 | | nF |
| $R_{th(j-s)}$ | per IGBT | | 0,9 | | K/W |
| $t_{d(on)}$ | under following conditions | | 85 | | ns |
| t_r | $V_{CC} = 600\text{ V, } V_{GE} = \pm 15\text{ V}$ | | 30 | | ns |
| $t_{d(off)}$ | $I_{Cnom} = 25\text{ A, } T_j = 125\text{ }^\circ\text{C}$ | | 465 | | ns |
| t_f | $R_{Gon} = R_{Goff} = 30\text{ }\Omega$ | | 100 | | ns |
| E_{on} | inductive load | | 3,5 | | mJ |
| E_{off} | | | 3 | | mJ |
| Diode - Inverter, Chopper | | | | | |
| $V_F = V_{EC}$ | $I_{Fnom} = 25\text{ A, } T_j = 25\text{ (125) }^\circ\text{C}$ | | 1,8 (1,8) | 2,1 (2,2) | V |
| $V_{(TO)}$ | $T_j = 25\text{ (125) }^\circ\text{C}$ | | 1 (0,8) | 1,1 (0,9) | V |
| r_T | $T_j = 25\text{ (125) }^\circ\text{C}$ | | 32 (40) | 40 (52) | $\text{m}\Omega$ |
| $R_{th(j-s)}$ | per diode | | 1,7 | | K/W |
| I_{RRM} | under following conditions | | 33 | | A |
| Q_{rr} | $I_{Fnom} = 25\text{ A, } V_R = 600\text{ V}$ | | 5,7 | | μC |
| E_{rr} | $V_{GE} = 0\text{ V, } T_j = 125\text{ }^\circ\text{C}$ | | 2,5 | | mJ |
| | $di_F/dt = 1140\text{ A}/\mu\text{s}$ | | | | |
| Diode - Rectifier | | | | | |
| V_F | $I_{Fnom} = 25\text{ A, } T_j = 25\text{ }^\circ\text{C}$ | | 1,1 | | V |
| $V_{(TO)}$ | $T_j = 150\text{ }^\circ\text{C}$ | | 0,8 | | V |
| r_T | $T_j = 150\text{ }^\circ\text{C}$ | | 13 | | $\text{m}\Omega$ |
| $R_{th(j-s)}$ | per diode | | 1,25 | | K/W |
| Temperature Sensor | | | | | |
| R_{ts} | 3 %, $T_r = 25\text{ (100) }^\circ\text{C}$ | | 1000(1670) | | Ω |
| Mechanical Data | | | | | |
| w | | | 65 | | g |
| M_s | Mounting torque | 2 | | 2,5 | Nm |

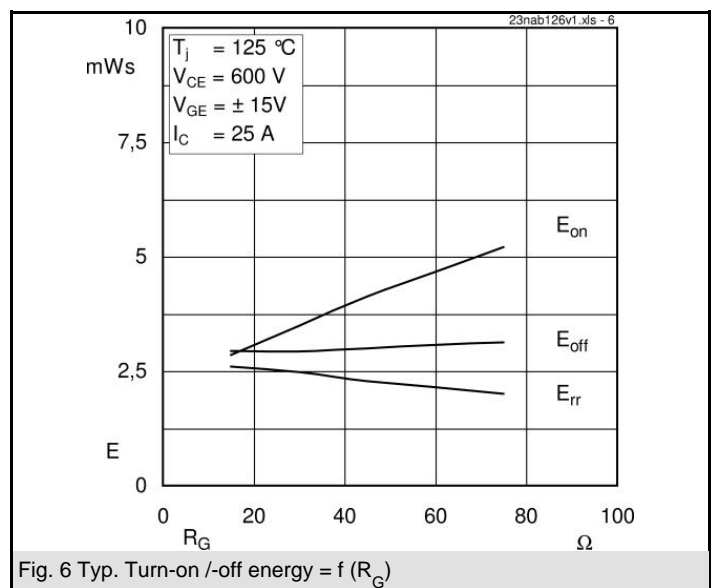
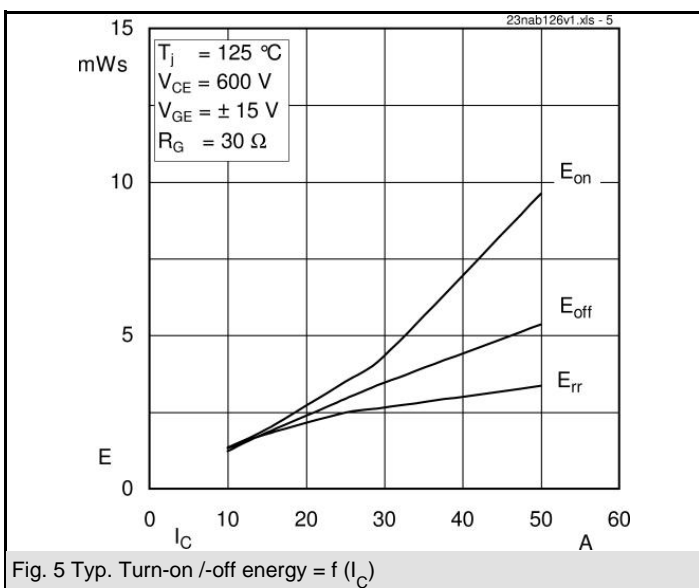
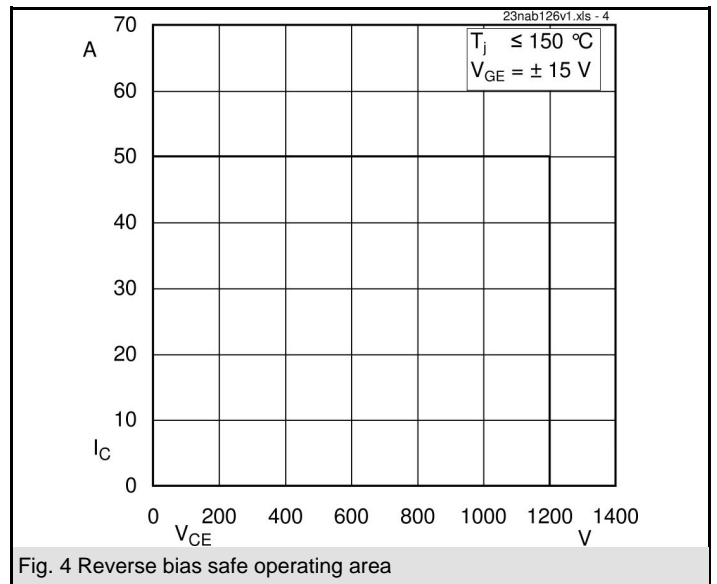
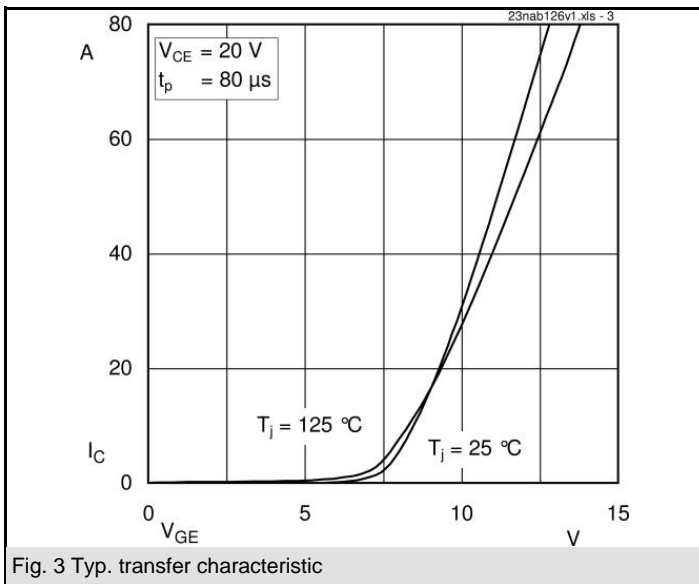
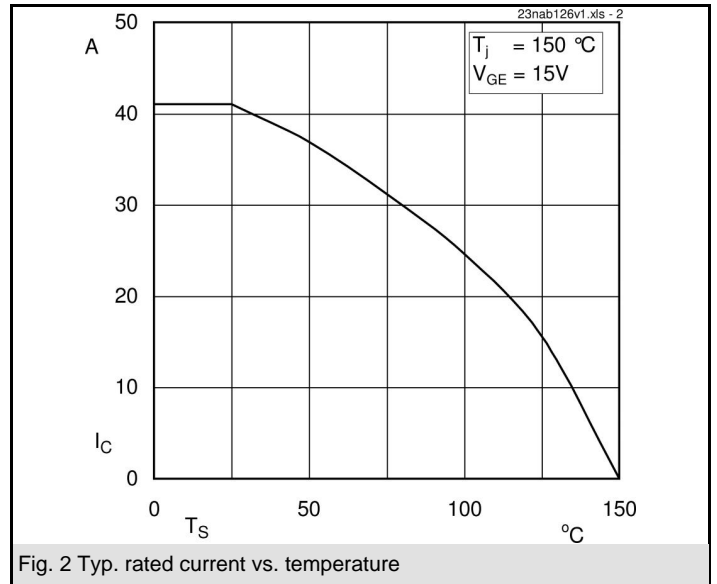
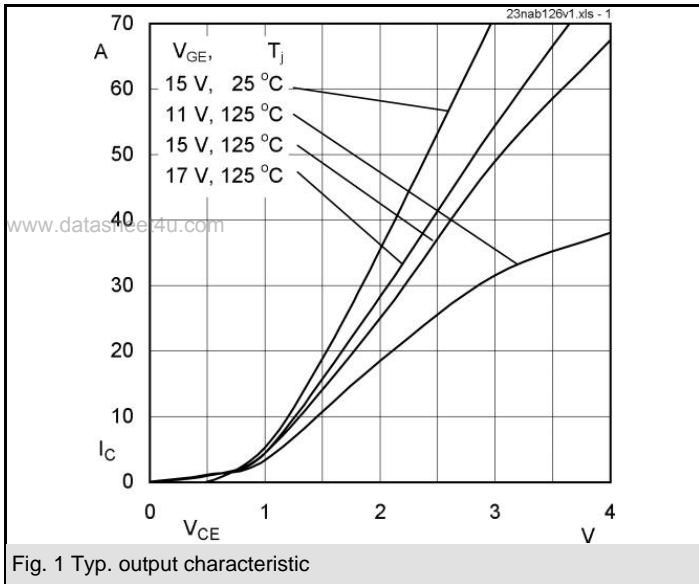

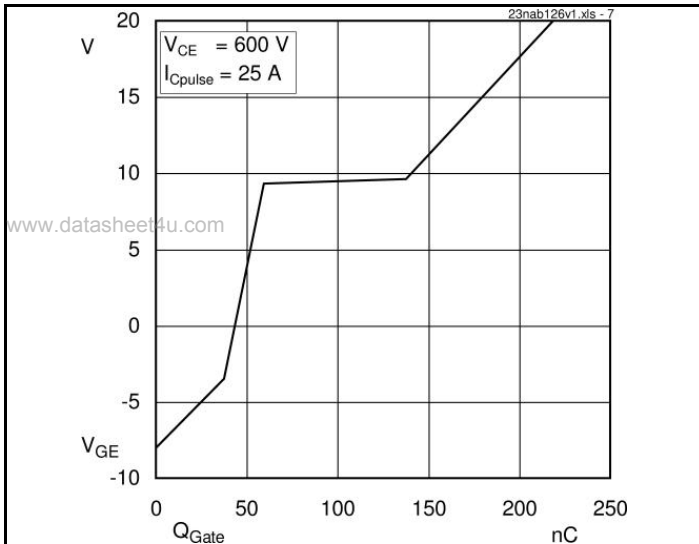

Fig. 7 Typ. gate charge characteristic

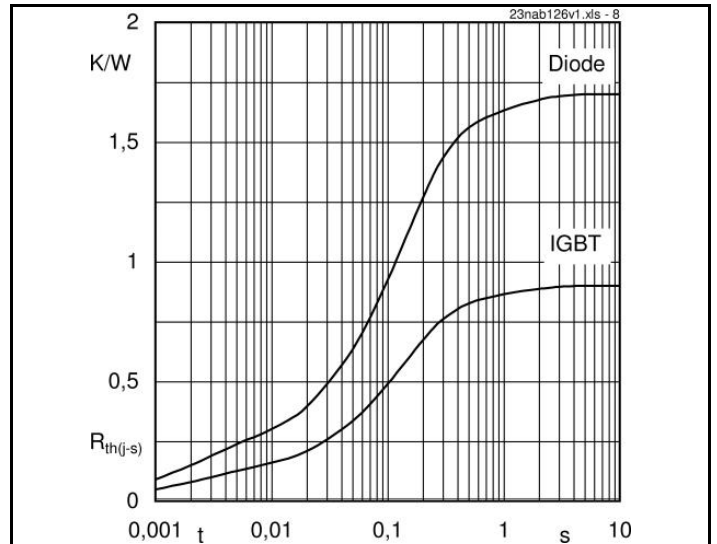

Fig. 8 Typ. thermal impedance

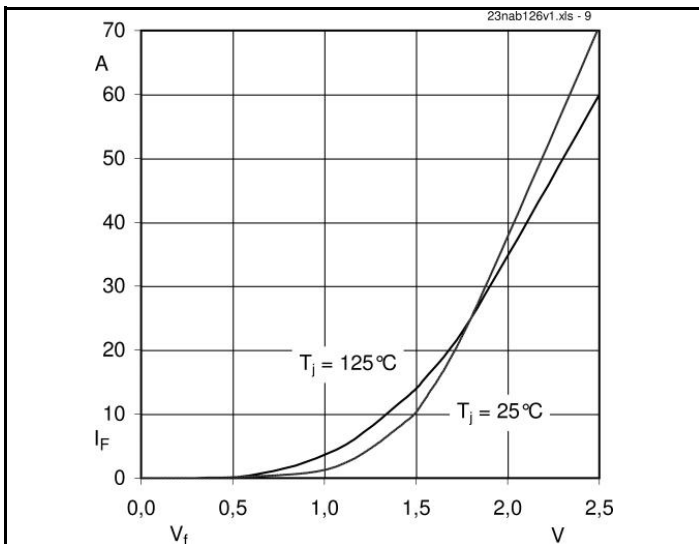

Fig. 9 Typ. freewheeling diode forward characteristic

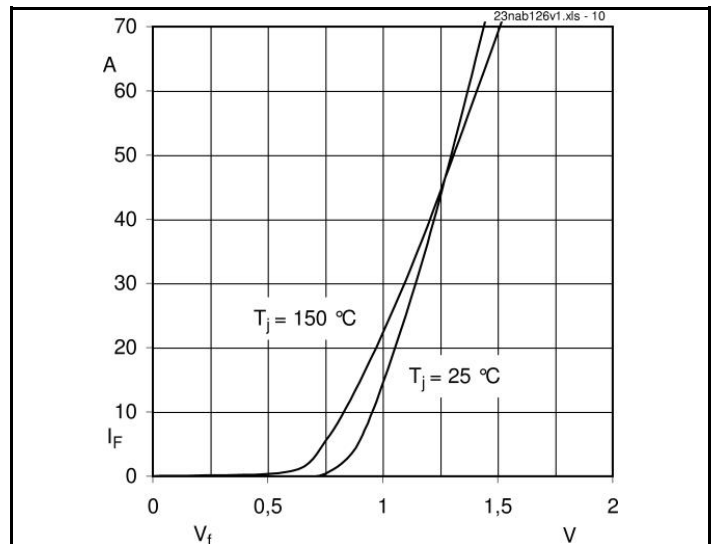
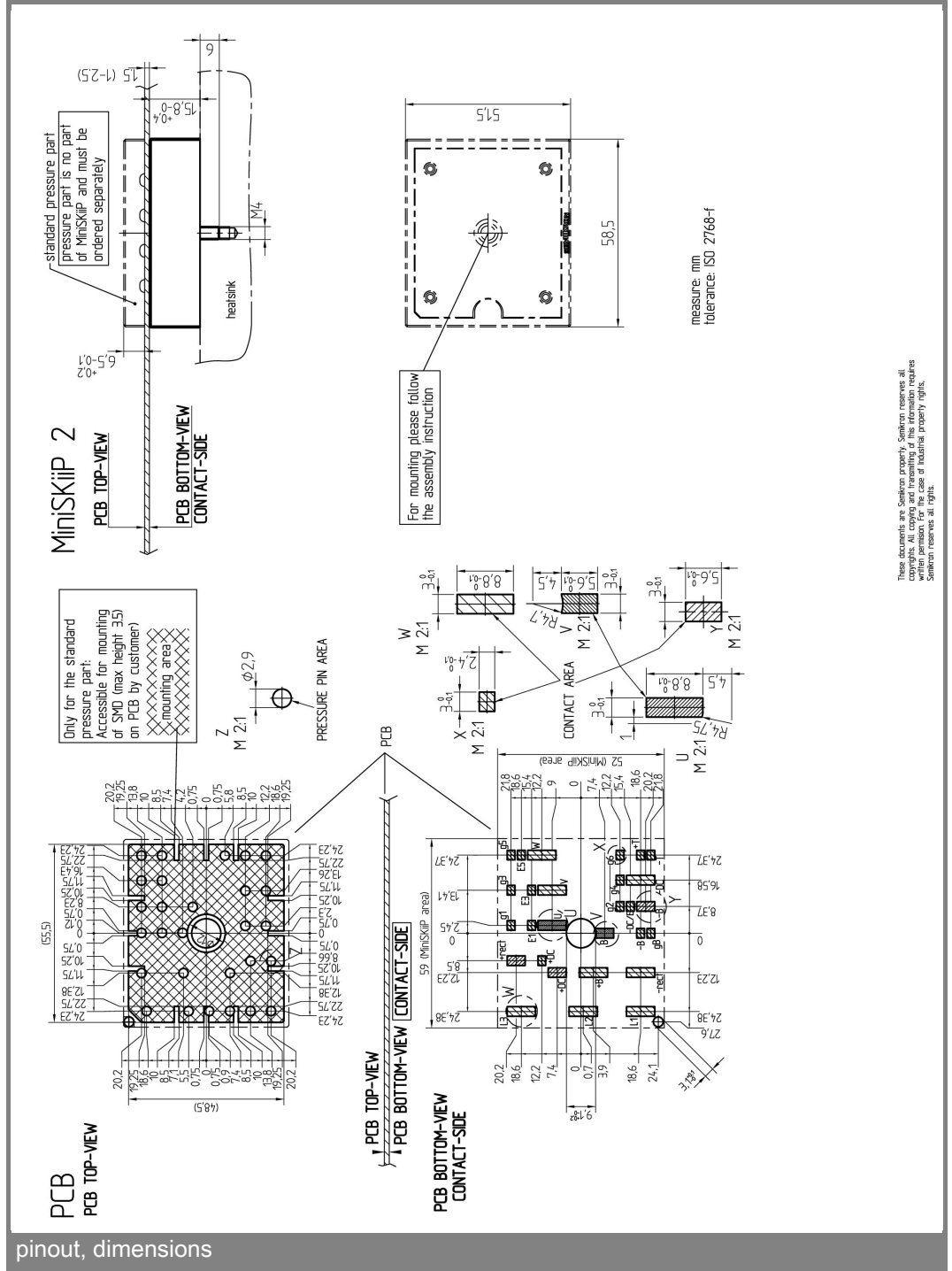
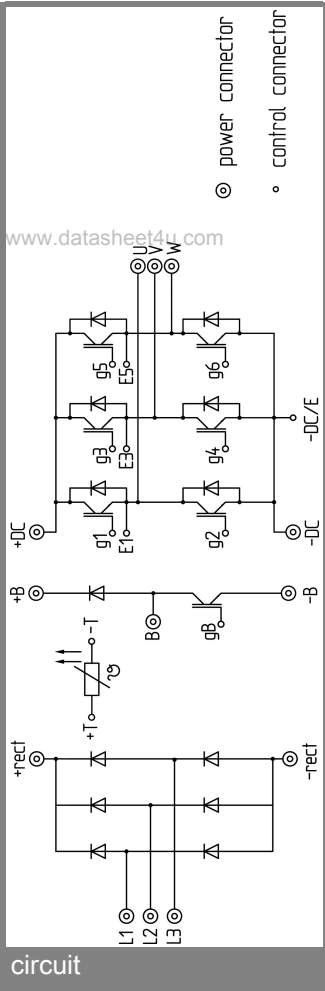

Fig. 10 Typ. input bridge forward characteristic



This is an electrostatic discharge sensitive device (ESDS), international standard IEC 60747-1, Chapter IX.

This technical information specifies semiconductor devices but promises no characteristics. No warranty or guarantee expressed or implied is made regarding delivery, performance or suitability.