

QUAD, ±16.5kV ESD Protected, 3.0V to 5.5V, Low Power, RS-422 Transmitters

The Intersil ISL32x7xE are ±16.5kV IEC61000-4-2 ESD Protected, 3.0V to 5.5V powered, QUAD transmitters for balanced communication using the RS-422 standard. These drivers have very low output leakage currents (±10µA), so they present a low load to the RS-422 bus.

Driver (Tx) outputs are tri-statable, and incorporate a hot plug feature to keep them disabled during power-up and down. Versions are available with a common EN/ \overline{EN} ('172 pinout), a two channel EN12/EN34 ('174 pinout), or a versatile combination of individual and group channel enables (see Table 1).

The ISL32372E, ISL32374E utilize slew rate limited drivers which reduce EMI, and minimize reflections from improperly terminated transmission lines, or from unterminated stubs in multidrop and multipoint applications. Drivers on the other versions are not limited, so they can achieve the 10Mbps or 32Mbps data rates. All versions are offered in Industrial and Extended Industrial (-40°C to +125°C) temperature ranges.

A 50% smaller footprint (compared to the TSSOP) is available with the ISL32179E's QFN package. This device also features a logic supply pin (V_L), that sets the switching points of the enable and DI inputs to be compatible with a lower supply voltage in mixed voltage systems. Two speed select pins allow the ISL32179E user to select from three slew rate options for 460kbps, 10Mbps, or 32Mbps data rates. Individual channel and group enable pins increase the ISL32179E's flexibility.

www.Intersil.com

Features

- IEC61000 ESD Protection on RS-422 Outputs ... ±16.5kV
 - Class 3 ESD Level on all Other Pins 12kV HBM
 - High Machine Model ESD Level on all Pins 700V
- Wide Supply Range 3.0V to 5.5V
- Specified for +125°C Operation
- Available in Industry Standard Pinouts ('172/'174) or in a Space Saving QFN (ISL32179E) with Added Features
- Logic Supply Pin (V_L) Eases Operation in Mixed Supply Systems (ISL32179E Only)
- User Selectable Data Rate (ISL32179E Only)
- Hot Plug - Tx Outputs Remain Three-state During Power-up and Power-Down
- Low Tx Leakage Allows > 256 Devices on the Bus
- High Data Rates up to 32Mbps
- Low Quiescent Supply Current 0.8mA (Max)
 - Low Shutdown Supply Current 60µA
- Current Limiting and Thermal Shutdown for Driver Overload Protection
- Tri-statable Tx Outputs
- 5V Tolerant Logic Inputs When $V_{CC} \leq 5V$
- Pb-free (RoHS compliant)

Applications

- Telecom Equipment
- Motor Controllers / Encoders
- Programmable Logic controllers
- Industrial/Process Control Networks

TABLE 1. SUMMARY OF FEATURES

| PART NUMBER | FUNCTION | DATA RATE (Mbps) | SLEW-RATE LIMITED? | HOT PLUG? | V_L PIN? | TX ENABLE TYPE | QUIESCENT I_{CC} (mA) | LOW POWER SHUTDOWN? | PIN COUNT |
|-------------|----------|------------------|--------------------|-----------|------------|--------------------------|-------------------------|---------------------|-----------|
| ISL32172E | 4 Tx | 32 | NO | YES | NO | EN, \overline{EN} | <1 | NO | 16 |
| ISL32272E | 4 Tx | 10 | NO | YES | NO | EN, \overline{EN} | <1 | NO | 16 |
| ISL32372E | 4 Tx | 0.46 | YES | YES | NO | EN, \overline{EN} | <1 | NO | 16 |
| ISL32174E | 4 Tx | 32 | NO | YES | NO | EN12, EN34 | <1 | NO | 16 |
| ISL32274E | 4 Tx | 10 | NO | YES | NO | EN12, EN34 | <1 | NO | 16 |
| ISL32374E | 4 Tx | 0.46 | YES | YES | NO | EN12, EN34 | <1 | NO | 16 |
| ISL32179E | 4 Tx | 32, 10, 0.46 | SELECTABLE | YES | YES | INDIV. AND GROUP ENABLES | <1 | YES | 24 |

Pinouts

ISL32172E, ISL32272E, ISL32372E
(16 LD N-SOIC, TSSOP)
TOP VIEWS

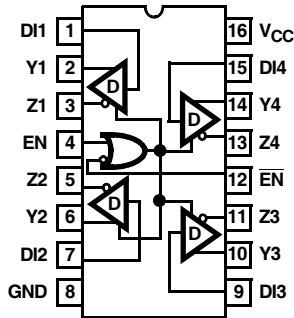

ISL32174E, ISL32274E, ISL32374E
(16 LD N-SOIC, TSSOP)
TOP VIEWS

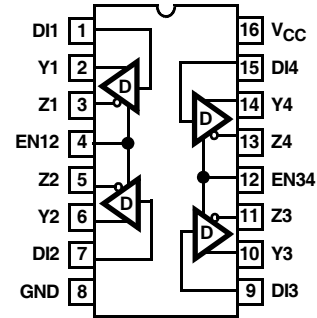

ISL32179E
(24 LD QFN)
TOP VIEW

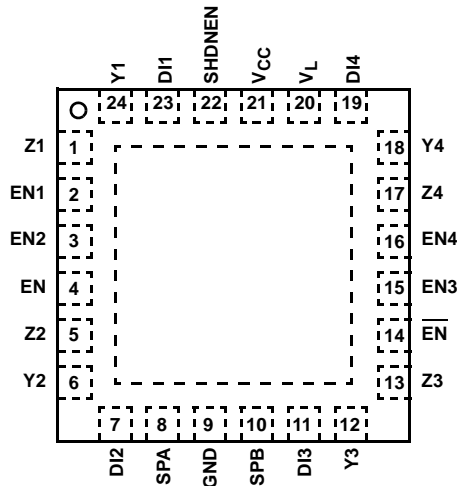

Ordering Information

| PART NUMBER (Notes 1, 2) | PART MARKING | TEMP. RANGE (°C) | PACKAGE (Pb-Free) | PKG. DWG. # |
|-----------------------------|---------------|---------------------|----------------------|----------------|
| ISL32172EFBZ | ISL32172 EFBZ | -40 to +125 | 16 Ld SOIC | M16.15 |
| ISL32172EFVZ | 32172 EFVZ | -40 to +125 | 16 Ld TSSOP | MDP0044 |
| ISL32172EIBZ | ISL32172 EIBZ | -40 to +85 | 16 Ld SOIC | M16.15 |
| ISL32172EIVZ | 32172 EIVZ | -40 to +85 | 16 Ld TSSOP | MDP0044 |
| ISL32174EFBZ | ISL32174 EFBZ | -40 to +125 | 16 Ld SOIC | M16.15 |
| ISL32174EFVZ | 32174 EFVZ | -40 to +125 | 16 Ld TSSOP | MDP0044 |
| ISL32174EIBZ | ISL32174 EIBZ | -40 to +85 | 16 Ld SOIC | M16.15 |
| ISL32174EIVZ | 32174 EIVZ | -40 to +85 | 16 Ld TSSOP | MDP0044 |
| ISL32179EFRZ | 321 79EFRZ | -40 to +125 | 24 Ld QFN | L24.4x4C |
| ISL32179EIRZ | 321 79EIRZ | -40 to +85 | 24 Ld QFN | L24.4x4C |
| ISL32272EFBZ | ISL32272 EFBZ | -40 to +125 | 16 Ld SOIC | M16.15 |
| ISL32272EFVZ | 32272 EFVZ | -40 to +125 | 16 Ld TSSOP | MDP0044 |
| ISL32272EIBZ | ISL32272 EIBZ | -40 to +85 | 16 Ld SOIC | M16.15 |
| ISL32272EIVZ | 32272 EIVZ | -40 to +85 | 16 Ld TSSOP | MDP0044 |

Ordering Information (Continued)

| PART NUMBER (Notes 1, 2) | PART MARKING | TEMP. RANGE (°C) | PACKAGE (Pb-Free) | PKG. DWG. # |
|-----------------------------|-----------------|---------------------|----------------------|----------------|
| ISL32274EFBZ | ISL32274 EFBZ | -40 to +125 | 16 Ld SOIC | M16.15 |
| ISL32274EFVZ | 32274 EFVZ | -40 to +125 | 16 Ld TSSOP | MDP0044 |
| ISL32274EIBZ | ISL32274 EIBZ | -40 to +85 | 16 Ld SOIC | M16.15 |
| ISL32274EIVZ | 32274 EIVZ | -40 to +85 | 16 Ld TSSOP | MDP0044 |
| ISL32372EFBZ | ISL32372 EFBZ | -40 to +125 | 16 Ld SOIC | M16.15 |
| ISL32372EFVZ | 32372 EFVZ | -40 to +125 | 16 Ld TSSOP | MDP0044 |
| ISL32372EIBZ | ISL32372 EIBZ | -40 to +85 | 16 Ld SOIC | M16.15 |
| ISL32372EIVZ | 32372 EIVZ | -40 to +85 | 16 Ld TSSOP | MDP0044 |
| ISL32374EFBZ | ISL32374 EFBZ | -40 to +125 | 16 Ld SOIC | M16.15 |
| ISL32374EFVZ | 32374 EFVZ | -40 to +125 | 16 Ld TSSOP | MDP0044 |
| ISL32374EIBZ | ISL32374 EIBZ | -40 to +85 | 16 Ld SOIC | M16.15 |
| ISL32374EIVZ | 32374 EIVZ | -40 to +85 | 16 Ld TSSOP | MDP0044 |

NOTES:

1. Add "-T" suffix for tape and reel. Please refer to TB347 for details on reel specifications.
2. These Intersil Pb-free plastic packaged products employ special Pb-free material sets, molding compounds/die attach materials, and 100% matte tin plate plus anneal (e3 termination finish, which is RoHS compliant and compatible with both SnPb and Pb-free soldering operations). Intersil Pb-free products are MSL classified at Pb-free peak reflow temperatures that meet or exceed the Pb-free requirements of IPC/JEDEC J STD-020

Truth Tables

| ISL32172E, ISL32272E, ISL32372E | | | | |
|---------------------------------|------------------------|-----|---------|-----|
| INPUTS | | | OUTPUTS | |
| EN | $\overline{\text{EN}}$ | DIX | ZX | YX |
| X | 0 | 1/0 | 0/1 | 1/0 |
| 1 | X | 0/1 | 1/0 | 0/1 |
| 0 | 1 | X | Z | Z |

NOTE: Z = Tri-state

| ISL32174E, ISL32274E, ISL32374E | | | | | | | | | | |
|---------------------------------|------|-----|---------|-----|-----|-----|-----|-----|-----|-----|
| INPUTS | | | OUTPUTS | | | | | | | |
| EN12 | EN34 | DIX | Z1 | Y1 | Z2 | Y2 | Z3 | Y3 | Z4 | Y4 |
| 0 | 0 | X | Z | Z | Z | Z | Z | Z | Z | Z |
| 0 | 1 | 1/0 | Z | Z | Z | Z | 0/1 | 1/0 | 0/1 | 1/0 |
| 1 | 0 | 1/0 | 0/1 | 1/0 | 0/1 | 1/0 | Z | Z | Z | Z |
| 1 | 1 | 1/0 | 0/1 | 1/0 | 0/1 | 1/0 | 0/1 | 1/0 | 0/1 | 1/0 |

NOTE: Z = Tri-state

| ISL32179E | | | | | | | | |
|-----------|----|------------------------|-----|-----|-----|---------|-----|--|
| INPUTS | | | | | | OUTPUTS | | |
| ENX | EN | $\overline{\text{EN}}$ | DIX | SPA | SPB | ZX | YX | COMMENTS |
| 0 | X | X | X | X | X | Z | Z | Chan X outputs disabled |
| X | 0 | 1 | X | X | X | Z | Z | All outputs disabled |
| 1 | X | 0 | 1/0 | 1 | 1 | 0/1 | 1/0 | Individual ENX controls chan X (32Mbps) |
| 1 | 1 | X | 0/1 | 1 | 1 | 1/0 | 0/1 | |
| 1 | X | 0 | 1/0 | 0 | 1 | 0/1 | 1/0 | Individual ENX controls chan X (10Mbps) |
| 1 | 1 | X | 0/1 | 0 | 1 | 1/0 | 0/1 | |
| 1 | X | 0 | 1/0 | X* | 0 | 0/1 | 1/0 | Individual ENX controls chan X (460kbps) |
| 1 | 1 | X | 0/1 | X* | 0 | 1/0 | 0/1 | |

NOTE: *Keep SPA = 1 for lowest current in SHDN. If using individual channel enables, and the SHDN mode, connect EN and $\overline{\text{EN}}$ to V_{CC} for the lowest SHDN current. ISL32179E enters SHDN when SHDNEN = 1 and all channels are disabled. Z = Tri-state.

Pin Descriptions

| PIN | FUNCTION |
|----------------------------|--|
| EN, $\overline{\text{EN}}$ | Group driver output enables, that are internally pulled high to V_{CC} . All ISL32x72E driver outputs, Y and Z, are enabled by driving EN high OR $\overline{\text{EN}}$ low, and the outputs are high impedance when EN is low AND $\overline{\text{EN}}$ is high (i.e., if using only the active high EN, connect EN directly to V_{CC} or V_L ; if using only the active low $\overline{\text{EN}}$, connect EN directly to GND). On the ISL32179E accomplish group enable by connecting all the ENX pins to V_{CC} or V_L , and then use the EN or $\overline{\text{EN}}$ pin as previously described. If the group driver enable function isn't required (see Note), connect EN to V_{CC} , or connect $\overline{\text{EN}}$ to GND. (ISL32x72E and ISL32179E only) |
| EN12, EN34 | Paired driver output enables, that are internally pulled high to V_{CC} . Driving EN12 (EN34) high enables Channel 1 and 2 (3 and 4) outputs (Y and Z). Driving EN12 (EN34) low disables Channel 1 and 2 (3 and 4) outputs. If the driver enable function isn't required (see Note), connect EN12 and EN34 to V_{CC} . (ISL32x74E only) |
| ENx | Individual driver output enables that are internally pulled high to V_{CC} . Forcing ENx high (along with EN high OR $\overline{\text{EN}}$ low) enables the channel X outputs (Y and Z). Driving ENX low disables the Channel X outputs, regardless of the states of EN and $\overline{\text{EN}}$. Connect both EN and $\overline{\text{EN}}$ to V_{CC} for the lowest SHDN current if utilizing SHDN mode (see SHDNEN below). If the individual driver enable function isn't required (see Note), connect ENX to V_{CC} . (ISL32179E only) |
| SHDNEN | Low power SHDN mode enable. A high level allows the ISL32179E to enter a low power mode when all channels are disabled. A low level prevents the device from entering the low power mode. (ISL32179E only) |
| DIx | Driver input. A low on DI forces the corresponding channel's output Y low and output Z high. Similarly, a high on DI forces output Y high and output Z low. |
| SPA, SPB | Speed select inputs that are internally pulled-high. See ISL32179E Truth Table on page 3. (ISL32179E only) |
| GND | Ground connection. This is also the potential of the QFN thermal pad. |
| Yx | $\pm 16.5\text{kV}$ IEC61000-4-2 ESD Protected RS-422 level, noninverting transmitter output. |
| Zx | $\pm 16.5\text{kV}$ IEC61000-4-2 ESD Protected RS-422 level, inverting transmitter output. |
| V_{CC} | System power supply input (3.0V to 5.5V). On devices with a V_L pin, power-up V_{CC} first. |
| V_L | Logic power supply input. Connecting the V_L pin to the lower voltage power supply of a logic device (e.g., UART or μ controller) interfacing with the ISL32179E tailors its logic pin (DI, EN (all varieties), SHDNEN, and SP) V_{IL}/V_{IH} levels to values compatible with the lower supply voltage. Power-up this supply after V_{CC} , and keep $V_L \leq V_{CC}$. (ISL32179E only) |

NOTE: Unused EN pins of any type should not be left floating, even though they have internal pull-ups.

Typical Operating Circuits (1 of 4 Channels Shown)

NETWORK USING GROUP ENABLES

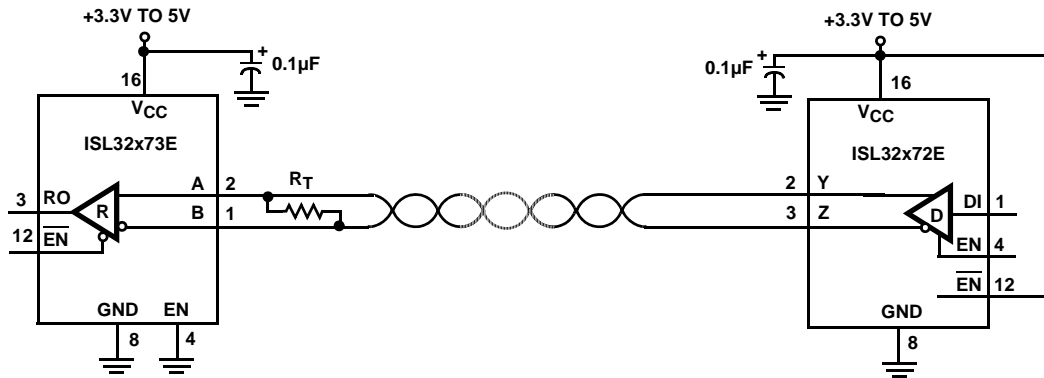

NETWORK USING PAIRED ENABLES

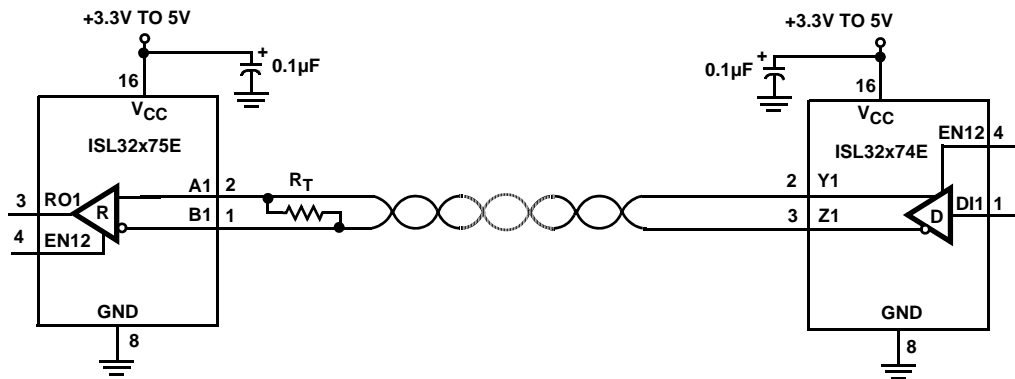

NETWORK WITH V_L PIN FOR INTERFACING TO LOWER VOLTAGE LOGIC DEVICES

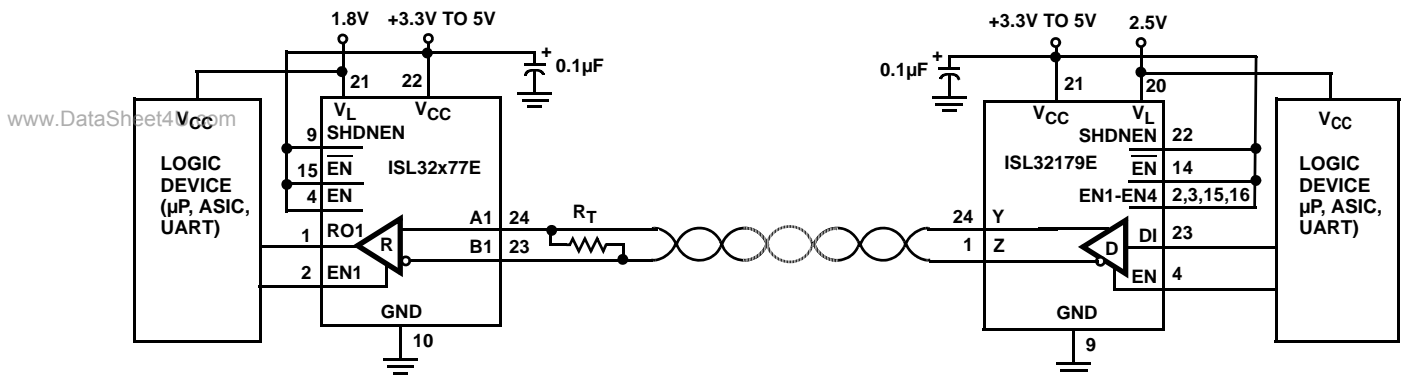

USING INDIVIDUAL CHANNEL ENABLES AND CONFIGURED FOR LOWEST SHDN SUPPLY CURRENT
NOTE: POWER-UP V_{CC} BEFORE V_L

USING ACTIVE HIGH GROUP ENABLE AND CONFIGURED FOR LOWEST SHDN SUPPLY CURRENT
NOTE: POWER-UP V_{CC} BEFORE V_L

Absolute Maximum Ratings

| | |
|---|----------------------------------|
| V _{CC} to GND | 7V |
| V _L to GND (ISL32179E Only) | -0.3V to (V _{CC} +0.3V) |
| Input Voltages | |
| DI, EN (all varieties) | -0.3V to 7V |
| Output Voltages | |
| Y, Z | -0.5V to 7V |
| Output Current | |
| Y, Z (Per Output, Continuous, T _J ≤ 125°C) | 100mA |
| ESD Rating | See Specification Table |

Thermal Information

| | | |
|---|------------------------|------------------------|
| Thermal Resistance (Typical) | θ _{JA} (°C/W) | θ _{JC} (°C/W) |
| 16 Ld SOIC Package (Note 3) | 80 | N/A |
| 16 Ld TSSOP Package (Note 3) | 105 | N/A |
| 24 Ld QFN Package (Notes 4, 5) | 42 | 5 |
| Maximum Junction Temperature (Plastic Package) | +150°C | |
| Maximum Storage Temperature Range | -65°C to +150°C | |
| Pb-free Reflow Profile | see link below | |
| http://www.intersil.com/pbfree/Pb-FreeReflow.asp | | |

Operating Conditions

| | |
|-------------------|-----------------|
| Temperature Range | |
| ISL32x7xEF | -40°C to +125°C |
| ISL32x7xEI | -40°C to +85°C |

CAUTION: Do not operate at or near the maximum ratings listed for extended periods of time. Exposure to such conditions may adversely impact product reliability and result in failures not covered by warranty.

NOTE:

- θ_{JA} is measured with the component mounted on a high effective thermal conductivity test board in free air. See Tech Brief TB379 for details.
- θ_{JA} is measured in free air with the component mounted on a high effective thermal conductivity test board with "direct attach" features. See Tech Brief TB379 for details.
- For θ_{JC}, the "case temp" location is the center of the exposed metal pad on the package underside.

Electrical Specifications Test Conditions: V_{CC} = 3.0V to 3.6V and 4.5V to 5.5V; V_L = V_{CC} (ISL32179E only); Typicals are at V_{CC} = 3.3V or V_{CC} = 5V, T_A = +25°C; Unless Otherwise Specified.(Notes 6, 10)

| PARAMETER | SYMBOL | TEST CONDITIONS | TEMP (°C) | MIN (Note 9) | TYP | MAX (Note 9) | UNITS | | |
|---|-------------------|---|------------------------|----------------------------|-----------------------------|---------------------|-------|---|---|
| DC CHARACTERISTICS | | | | | | | | | |
| Differential V _{OUT} | V _{OD} | No Load | Full | 2.5 | - | V _{CC} | | | |
| | | R _L = 100Ω (RS-422) (see Figure 1) | V _{CC} ≥ 3V | Full | 2 | 2.6 | - | V | |
| | | | V _{CC} ≥ 4.5V | Full | 3 | 4 | - | V | |
| Single-Ended V _{OUT} (Y or Z) | V _O | I _O = -20mA, V _{OH} | Full | 2.4 | 2.7 | - | V | | |
| | | I _O = 20mA, V _{OL} | Full | - | 0.2 | 0.4 | V | | |
| Change in Magnitude of Driver Differential V _{OUT} for Complementary Output States | ΔV _{OD} | R _L = 100Ω (see Figure 1) | Full | - | 0.01 | 0.2 | V | | |
| Driver Common-Mode V _{OUT} | V _{OC} | R _L = 100Ω (see Figure 1) | Full | - | 2.6 | 3 | V | | |
| Change in Magnitude of Driver Common-Mode V _{OUT} for Complementary Output States | ΔV _{OC} | R _L = 100Ω (see Figure 1) | Full | - | 0.01 | 0.2 | V | | |
| Input High Voltage (Logic Pins, Note 14) | V _{IH1} | V _L = V _{CC} if ISL32179E | V _{CC} ≤ 3.6V | Full | 2.2 | - | - | V | |
| | V _{IH2} | | | V _{CC} ≤ 5.5V, DI | Full | 2.7 | - | - | V |
| | V _{IH2E} | | | | V _{CC} ≤ 5.5V, ENs | Full | 2.4 | - | - |
| | V _{IH3} | 2.7V ≤ V _L < 3.0V (ISL32179E Only) | Full | 2 | | - | - | V | |
| | V _{IH4} | 2.3V ≤ V _L < 2.7V (ISL32179E Only) | Full | 1.6 | - | - | V | | |
| | V _{IH5} | 1.6V ≤ V _L < 2.3V (ISL32179E Only) | Full | 0.72*V _L | - | - | V | | |
| | V _{IH6} | 1.5V ≤ V _L < 1.6V (ISL32179E Only) | 25 | - | 0.45*V _L | - | V | | |
| Input Low Voltage (Logic Pins, Note 14) | V _{IL1} | V _L = V _{CC} if ISL32179E | Full | - | - | 0.8 | V | | |
| | V _{IL2} | V _L ≥ 2.7V (ISL32179E Only) | Full | - | - | 0.6 | V | | |
| | V _{IL3} | 2.3V ≤ V _L < 2.7V (ISL32179E Only) | Full | - | - | 0.6 | V | | |
| | V _{IL4} | 1.6V ≤ V _L < 2.3V (ISL32179E Only) | Full | - | - | 0.22*V _L | V | | |
| | V _{IL5} | 1.5V ≤ V _L < 1.6V (ISL32179E Only) | 25 | - | 0.25*V _L | - | V | | |

Electrical Specifications Test Conditions: $V_{CC} = 3.0V$ to $3.6V$ and $4.5V$ to $5.5V$; $V_L = V_{CC}$ (ISL32179E only); Typicals are at $V_{CC} = 3.3V$ or $V_{CC} = 5V$, $T_A = +25^{\circ}C$; Unless Otherwise Specified. (Notes 6, 10) (Continued)

| PARAMETER | SYMBOL | TEST CONDITIONS | TEMP (°C) | MIN (Note 9) | TYP | MAX (Note 9) | UNITS | |
|--|-----------------------|---|-----------|--------------|----------|--------------|-------------|----|
| Logic Input Current | I_{IN1} | DIX = 0V or V_{CC} | Full | -1 | - | 1 | μA | |
| | I_{IN2} | SP, EN, \overline{EN} , ENX, SHDNEN = 0V or V_{CC} | Full | -15 | 9 | 15 | μA | |
| | I_{IN3} | EN12, EN34 = 0V or V_{CC} | Full | -30 | 18 | 30 | μA | |
| Output Leakage Current (Y, Z) | I_{OZ} | EN = 0, $V_{CC} = 0V$ to $5.5V$, $-0.25 \leq V_O \leq 6V$ | Full | -10 | - | 10 | μA | |
| | | EN = 0, $V_{CC} = 3V$ to $5.5V$, $V_O = 0V$ to V_{CC} | | 25 | - | 8 | nA | |
| | | (Note 16) | | -30 | - | 30 | nA | |
| Driver Short-Circuit Current, $V_O =$ High or Low | I_{OSD1} | EN = 1, V_Y or $V_Z = 0V$ (Note 7) | Full | - | - | ± 150 | mA | |
| | | EN = 1, V_Y or $V_Z = V_{CC}$ (Note 7) | Full | - | - | ± 200 | mA | |
| Thermal Shutdown Threshold | T_{SD} | | Full | - | 160 | - | $^{\circ}C$ | |
| SUPPLY CURRENT | | | | | | | | |
| No-Load Supply Current | I_{CC} | DI = 0V or V_{CC} , EN = 1 | Full | - | 0.6 | 0.8 | mA | |
| Shutdown Supply Current | I_{SHDN} | DI = 0V or V_{CC} , All outputs disabled (Note 15), SHDNEN = 1 (ISL32179E only) | Full | - | 60 | 90 | μA | |
| ESD PERFORMANCE | | | | | | | | |
| RS-422 Pins (Y, Z) | | IEC61000-4-2, From Bus Pins to GND | Air Gap | 25 | - | ± 16.5 | - | kV |
| | | | Contact | 25 | - | ± 9 | - | kV |
| | | Human Body Model, From Bus Pins to GND | 25 | - | ± 15 | - | kV | |
| All Pins | | HBM, per MIL-STD-883 Method 3015 | 25 | - | ± 12 | - | kV | |
| | | Machine Model | 25 | - | 700 | - | V | |
| DRIVER SWITCHING CHARACTERISTICS (ISL32372E, ISL32374E, ISL32179E, 460kbps) | | | | | | | | |
| Maximum Data Rate | f_{MAX} | $V_{OD} = \pm 1.5V$, $C_D = 820pF$ (see Figure 4) | Full | 460 | 4000 | - | kbps | |
| Driver Single-Ended Output Delay | t_{PLH} , t_{PHL} | $R_{DIFF} = 100\Omega$, $C_D = 50pF$ (see Figure 2) | Full | - | 90 | 300 | ns | |
| Driver Single-Ended Output Skew | t_{SSK} | $R_{DIFF} = 100\Omega$, $C_D = 50pF$ (see Figure 2) | Full | - | 55 | 150 | ns | |
| Ch-to-Ch Output Delay Skew | t_{SKCC} | (Figure 2, Note 11) | Full | - | 60 | 200 | ns | |
| Part-to-Part Output Delay Skew | t_{SKPP} | (Figure 2, Note 8) | Full | - | - | 300 | ns | |
| Driver Differential Output Skew | t_{DSK} | $R_{DIFF} = 100\Omega$, $C_D = 50pF$ (see Figure 2) | Full | - | 2 | 60 | ns | |
| Driver Differential Rise or Fall Time | t_R , t_F | $R_{DIFF} = 100\Omega$, $C_D = 50pF$ (see Figure 2) | Full | 60 | 100 | 220 | ns | |
| Driver Enable to Output High | t_{ZH} | SW = GND (see Figure 3, Note 12) | Full | - | - | 200 | ns | |
| Driver Enable to Output Low | t_{ZL} | SW = V_{CC} (see Figure 3, Note 12) | Full | - | - | 200 | ns | |
| Driver Disable from Output High | t_{HZ} | SW = GND (see Figure 3) | Full | - | - | 100 | ns | |
| Driver Disable from Output Low | t_{LZ} | SW = V_{CC} (see Figure 3) | Full | - | - | 100 | ns | |
| Driver Enable from SHDN to High | t_{SDH} | ISL32179E Only, SW = GND (see Figure 3, Note 13) | Full | - | - | 750 | ns | |
| Driver Enable from SHDN to Low | t_{SDL} | ISL32179E Only, SW = V_{CC} (see Figure 3, Note 13) | Full | - | - | 750 | ns | |
| DRIVER SWITCHING CHARACTERISTICS (ISL32272E, ISL32274E, ISL32179E, 10Mbps) | | | | | | | | |
| Maximum Data Rate | f_{MAX} | $V_{OD} = \pm 1.5V$, $C_D = 400pF$ (see Figure 4) | Full | 10 | 20 | - | Mbps | |
| Driver Single-Ended Output Delay | t_{PLH} , t_{PHL} | $R_{DIFF} = 100\Omega$, $C_D = 50pF$ (see Figure 2) | Full | - | 13 | 25 | ns | |
| Driver Single-Ended Output Skew | t_{SSK} | $R_{DIFF} = 100\Omega$, $C_D = 50pF$ (see Figure 2) | Full | - | 2 | 9 | ns | |
| Ch-to-Ch Output Delay Skew | t_{SKCC} | (Figure 2, Note 11) | Full | - | 6 | 12 | ns | |
| Part-to-Part Output Delay Skew | t_{SKPP} | (Figure 2, Note 8) | Full | - | - | 20 | ns | |
| Driver Differential Output Skew | t_{DSK} | $R_{DIFF} = 100\Omega$, $C_D = 50pF$ (see Figure 2) | Full | - | 2 | 6 | ns | |
| Driver Differential Rise or Fall Time | t_R , t_F | $R_{DIFF} = 100\Omega$, $C_D = 50pF$ (see Figure 2) | Full | 7 | 11 | 20 | ns | |
| Driver Enable to Output High | t_{ZH} | SW = GND (see Figure 3, Note 12) | Full | - | - | 20 | ns | |
| Driver Enable to Output Low | t_{ZL} | SW = V_{CC} (see Figure 3, Note 12) | Full | - | - | 20 | ns | |

Electrical Specifications Test Conditions: $V_{CC} = 3.0V$ to $3.6V$ and $4.5V$ to $5.5V$; $V_L = V_{CC}$ (ISL32179E only); Typicals are at $V_{CC} = 3.3V$ or $V_{CC} = 5V$, $T_A = +25^{\circ}C$; Unless Otherwise Specified. (Notes 6, 10) **(Continued)**

| PARAMETER | SYMBOL | TEST CONDITIONS | TEMP (°C) | MIN (Note 9) | TYP | MAX (Note 9) | UNITS |
|---|-----------------------|---|-----------|--------------|-----|--------------|-------|
| Driver Disable from Output High | t_{HZ} | SW = GND (see Figure 3) | Full | - | - | 20 | ns |
| Driver Disable from Output Low | t_{LZ} | SW = V_{CC} (see Figure 3) | Full | - | - | 20 | ns |
| Driver Enable from SHDN to High | t_{SDH} | ISL32179E Only, SW = GND (see Figure 3, Note 13) | Full | - | - | 750 | ns |
| Driver Enable from SHDN to Low | t_{SDL} | ISL32179E Only, SW = V_{CC} (see Figure 3, Note 13) | Full | - | - | 750 | ns |
| DRIVER SWITCHING CHARACTERISTICS (ISL32172E, ISL32174E, ISL32179E, 32Mbps) | | | | | | | |
| Maximum Data Rate | f_{MAX} | $V_{OD} = \pm 1.5V$, $C_D = 100pF$ (see Figure 4) | Full | 32 | 50 | - | Mbps |
| Driver Single-Ended Output Delay | t_{PLH} , t_{PHL} | $R_{DIFF} = 100\Omega$, $C_D = 50pF$ (see Figure 2) | Full | 3 | 8 | 15 | ns |
| Driver Single-Ended Output Skew | t_{SSK} | $R_{DIFF} = 100\Omega$, $C_D = 50pF$ (see Figure 2) | Full | - | 1 | 3.5 | ns |
| Ch-to-Ch Output Delay Skew | t_{SKCC} | (Figure 2, Note 11) | Full | - | 3 | 5.5 | ns |
| Part-to-Part Output Delay Skew | t_{SKPP} | (Figure 2, Note 8) | Full | - | - | 8 | ns |
| Driver Differential Output Skew | t_{DSK} | $R_{DIFF} = 100\Omega$, $C_D = 50pF$ (see Figure 2) | Full | - | 0.5 | 2 | ns |
| Driver Differential Rise or Fall Time | t_R , t_F | $R_{DIFF} = 100\Omega$, $C_D = 50pF$ (see Figure 2) | Full | - | 7 | 12 | ns |
| Driver Enable to Output High | t_{ZH} | SW = GND (see Figure 3, Note 12) | Full | - | - | 20 | ns |
| Driver Enable to Output Low | t_{ZL} | SW = V_{CC} (see Figure 3, Note 12) | Full | - | - | 20 | ns |
| Driver Disable from Output High | t_{HZ} | SW = GND (see Figure 3) | Full | - | - | 20 | ns |
| Driver Disable from Output Low | t_{LZ} | SW = V_{CC} (see Figure 3) | Full | - | - | 20 | ns |
| Driver Enable from SHDN to High | t_{SDH} | ISL32179E Only, SW = GND (see Figure 3, Note 13) | Full | - | - | 750 | ns |
| Driver Enable from SHDN to Low | t_{SDL} | ISL32179E Only, SW = V_{CC} (see Figure 3, Note 13) | Full | - | - | 750 | ns |

NOTES:

- All currents into device pins are positive; all currents out of device pins are negative. All voltages are referenced to device ground unless otherwise specified.
- Applies to peak current. See "Typical Performance Curves" beginning on page 12 for more information.
- t_{SKPP} is the magnitude of the difference in propagation delays of the specified terminals of two units tested with identical test conditions (V_{CC} , temperature, etc.).
- Parameters with MIN and/or MAX limits are 100% tested at $+25^{\circ}C$, unless otherwise specified. Temperature limits established by characterization and are not production tested.
- EN = 0 indicates that the output(s) under test are disabled via the appropriate logic pin settings. EN = 1 indicates that the logic pins are set to enable the output(s) under test.
- Channel-to-channel skew is the magnitude of the worst case delta between any two propagation delays of any two outputs on the same IC, at the same test conditions.
- For ISL32179E, keep SHDNEN low to avoid entering SHDN.
- Keep SHDNEN high to enter SHDN when all transmitters are disabled (ISL32179E only).
- Logic Pins are the DIs, the enable variants, and SHDNEN.
- Only one of the SPX pins low, plus EN1-EN4 low with EN and \overline{EN} high, or EN low and \overline{EN} high with EN1-EN4 high.
- Temperature range is $-20^{\circ}C$ to $+40^{\circ}C$.

Test Circuits and Waveforms

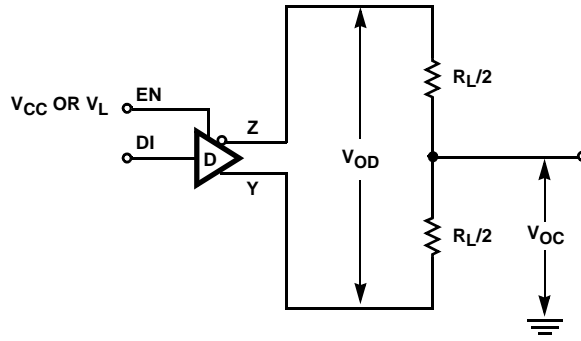

FIGURE 1. DC DRIVER TEST CIRCUITS

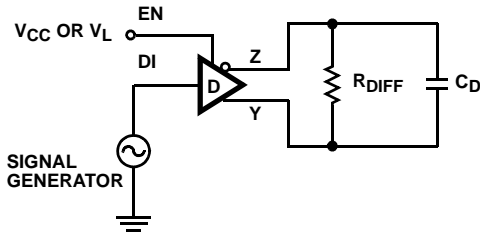

FIGURE 2A. TEST CIRCUIT

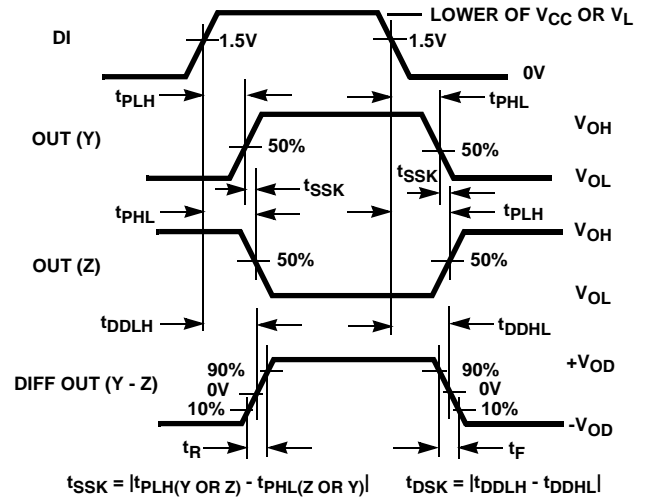
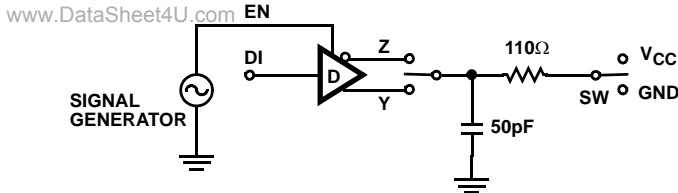

FIGURE 2B. MEASUREMENT POINTS

FIGURE 2. DRIVER PROPAGATION DELAY AND DIFFERENTIAL TRANSITION TIMES



| PARAMETER | OUTPUT | DI | SW |
|---------------------|--------|-----|----------|
| t_{HZ} | Y/Z | 1/0 | GND |
| t_{LZ} | Y/Z | 0/1 | V_{CC} |
| t_{ZH} (Note 12) | Y/Z | 1/0 | GND |
| t_{ZL} (Note 12) | Y/Z | 0/1 | V_{CC} |
| t_{SDH} (Note 13) | Y/Z | 1/0 | GND |
| t_{SDL} (Note 13) | Y/Z | 0/1 | V_{CC} |

FIGURE 3A. TEST CIRCUIT

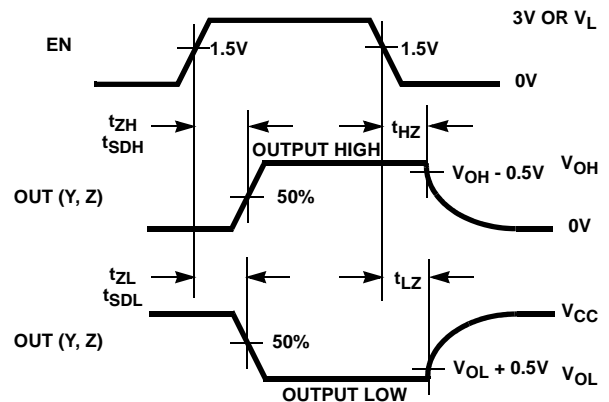

FIGURE 3B. MEASUREMENT POINTS

FIGURE 3. DRIVER ENABLE AND DISABLE TIMES

Test Circuits and Waveforms (Continued)

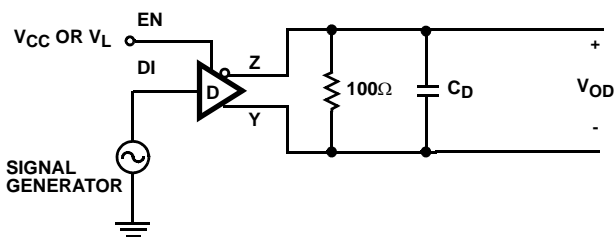

FIGURE 4A. TEST CIRCUIT

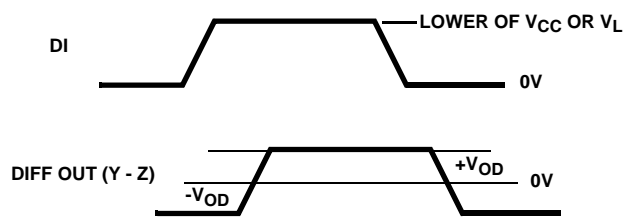

FIGURE 4B. MEASUREMENT POINTS

FIGURE 4. DRIVER DATA RATE

Application Information

RS-422 is a differential (balanced) data transmission standard for use in long haul or noisy environments. RS-422 is a point-to-multipoint (multidrop) standard, which allows only one driver and up to 10 (assuming one unit load devices) receivers on each bus.

Driver Features

These RS-422 drivers are differential output devices that deliver at least 2V across a 100Ω load. The drivers feature low propagation delay skew to maximize bit width, and to minimize EMI.

The 460kbps driver outputs are slew rate limited to minimize EMI, and to reduce reflections in unterminated or improperly terminated networks. Outputs of the 10Mbps and 32Mbps drivers are not limited, so faster output transition times allow the higher data rates.

Driver Enable Functions

All product types include functionality to allow disabling of the Tx outputs. The ISL32x72E types feature group (all four Tx) enable functions that are active high (EN) or active low (\overline{EN}). Drivers enable when EN = 1, or when \overline{EN} = 0, and they disable only when EN = 0 and \overline{EN} = 1. ISL32x74E versions use active high paired enable functions (EN12 and EN34) that enable (when high) or disable (when low) the corresponding pairs of Tx. All four of these enable pins have internal pull-up resistors to V_{CC} , but unused enable pins that need to be high (e.g., \overline{EN} when using the EN input for enable control, or EN12 and EN34 when using always enabled drivers) should always be connected externally to V_{CC} . If V_{CC} transients might exceed 7V, then inserting a series resistor between the input(s) and V_{CC} limits the current that will flow if the input's ESD protection starts conducting.

The ISL32179E has the most flexible enable scheme. Its six enable pins allow for group, paired, or individual channel enable control. Figure 5 details the ISL32179E's internal enable logic. To utilize a group enable function, connect all the ENx pins high, and handle the EN and \overline{EN} pins as described in the previous paragraph. For paired enables, connect EN and \overline{EN} high (for the lowest current in SHDN mode, if SHDN is used) and tie EN1 and EN2 together, and

EN3 and EN4 together. For individual channel enables, again connect EN and \overline{EN} high, and drive the appropriate ENX (active high) for the particular channel. All of the enable pins incorporate pull-up resistors to V_{CC} , but unused enable pins of any type should be externally connected high, rather than being left floating. Connecting to V_{CC} is the best choice, but V_L may be utilized as long as SHDN power isn't a primary concern (for each V_L connected input, I_{CC} increases by $((V_{CC} - V_L)/600k\Omega)$. If V_{CC} or V_L transients might exceed 7V, then inserting a series resistor between the input(s) and the supply limits the current that will flow if the input's ESD protection starts conducting.

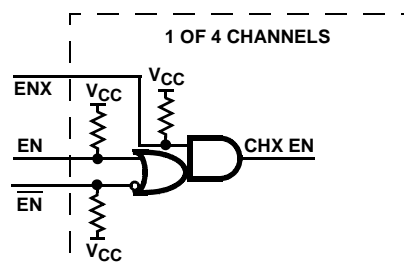

FIGURE 5. ISL32179E ENABLE LOGIC

Wide Supply Range

These ICs are designed to operate with a wide range of supply voltages from 3.0V to 5.5V, and they meet the RS-422 specifications for that full supply voltage range.

5.5V TOLERANT LOGIC PINS

Logic input pins (driver inputs, enables, SHDNEN) contain no ESD nor parasitic diodes to V_{CC} (nor to V_L), so they withstand input voltages exceeding 5.5V regardless of the V_{CC} and V_L voltages. Input voltages up to 7V are easily tolerated.

Logic Supply (V_L Pin, ISL32179E Only)

Note: Power-up V_{CC} before powering up the V_L supply. If unused enable pins are connected to V_L rather than to V_{CC} , then a small I_{CC} $((V_{CC} - V_L)/600k\Omega)$ will flow due to the internal pull-up resistor connecting to V_{CC} .

The ISL32179E includes a V_L pin that powers the logic inputs (driver inputs, enables, SHDNEN). These pins interface with "logic" devices such as UARTs, ASICs, and

μcontrollers, and today most of these devices use power supplies significantly lower than 3.3V. Thus, the logic device's low V_{OH} might not exceed the V_{IH} of a 3.3V or 5V powered DI or enable input. Connecting the V_L pin to the power supply of the logic device (as shown in Figure 6) reduces the DI and enable input switching points to values compatible with the logic device's output levels. Tailoring the logic pin input switching points to the supply voltage of the UART, ASIC, or μcontroller eliminates the need for a level shifter/translator between the two ICs.

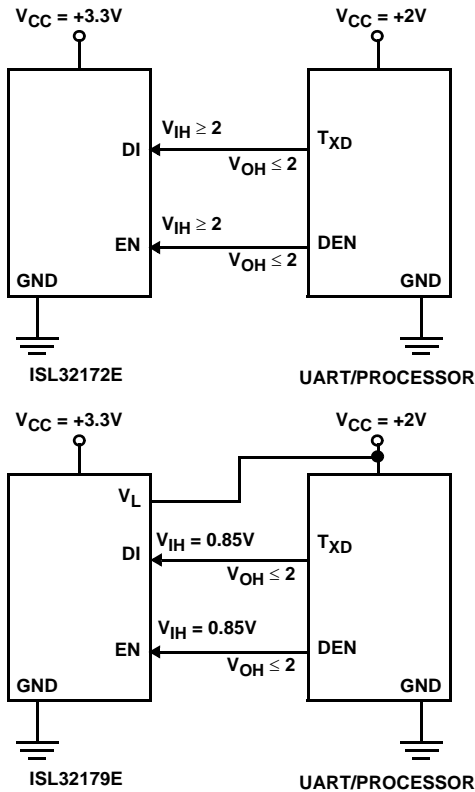

FIGURE 6. USING V_L PIN TO ADJUST LOGIC LEVELS

V_L can be anywhere from V_{CC} down to 1.5V, and Table 2 indicates typical V_{IH} and V_{IL} values for various V_L settings so the user can ascertain whether or not a particular V_L voltage meets his needs.

TABLE 2. V_{IH} AND V_{IL} vs V_L FOR $V_{CC} = 3.3V$ OR $5V$

| V_L (V) | V_{IH} (V) | V_{IL} (V) |
|-----------|---------------------|--------------|
| 1.6 | 0.7 | 0.45 |
| 2 | 0.85 | 0.6 |
| 2.3 | 1.1 | 0.75 |
| 2.7 | 1.4 (DI), 1.1 (ENs) | 0.85 |
| 2.7 | 2 | 0.8 |
| 3.3 | 2.2 | 0.8 |

Hot Plug Function

When a piece of equipment powers up, there is a period of time where the processor or ASIC driving the RS-422 control lines (EN, \overline{EN} , ENx) is unable to ensure that the RS-422 Tx outputs remain disabled. If the equipment is connected to the bus, a driver activating prematurely during power-up may drive invalid data on the bus. To avoid this scenario, this family incorporates a "Hot Plug" function. During power-up, circuitry monitoring V_{CC} ensures that the Tx outputs remain disabled for a period of time, regardless of the state of the enable pins. This gives the processor/ASIC a chance to stabilize and drive the RS-422 control lines to the proper states.

ESD Protection

All pins on these devices include class 3 (>12kV) Human Body Model (HBM) ESD protection structures, but the RS-422 pins (driver outputs) incorporate advanced structures allowing them to survive ESD events in excess of $\pm 15kV$ HBM, and $\pm 16.5kV$ to IEC61000-4-2. The RS-422 pins are particularly vulnerable to ESD damage because they typically connect to an exposed port on the exterior of the finished product. Simply touching the port pins, or connecting a cable, can cause an ESD event that might destroy unprotected ICs. These new ESD structures protect the device whether or not it is powered up, and without degrading the RS-422 common mode range of -0.3V to +6V. This built-in ESD protection eliminates the need for board level protection structures (e.g., transient suppression diodes), and the associated, undesirable capacitive load they present.

IEC61000-4-2 Testing

The IEC61000 test method applies to finished equipment, rather than to an individual IC. Therefore, the pins most likely to suffer an ESD event are those that are exposed to the outside world (the RS-422 pins in this case), and the IC is tested in its typical application configuration (power applied) rather than testing each pin-to-pin combination. The IEC61000 standard's lower current limiting resistor coupled with the larger charge storage capacitor yields a test that is much more severe than the HBM test. The extra ESD protection built into this device's RS-422 pins allows the design of equipment meeting level 4 criteria without the need for additional board level protection on the RS-422 port.

AIR-GAP DISCHARGE TEST METHOD

For this test method, a charged probe tip moves toward the IC pin until the voltage arcs to it. The current waveform delivered to the IC pin depends on approach speed, humidity, temperature, etc., so it is difficult to obtain repeatable results. The RS-422 pins withstand $\pm 16.5kV$ air-gap discharges.

CONTACT DISCHARGE TEST METHOD

During the contact discharge test, the probe contacts the tested pin before the probe tip is energized, thereby eliminating the variables associated with the air-gap

discharge. The result is a more repeatable and predictable test, but equipment limits prevent testing devices at voltages higher than ±9kV. Devices in this family survive ±9kV contact discharges on the RS-422 pins.

Data Rate, Cables, and Terminations

RS-422 is intended for network lengths up to 4000', but the maximum system data rate decreases as the transmission length increases. Devices operating at 32Mbps handle lengths up to 328' (100m) in 5V systems, and lengths up to 200' (62m) in 3.3V systems (see Figures 31 and 32). The 460kbps versions can operate at full data rates with lengths of thousands of feet. Note that system jitter requirements may limit a network to shorter distances.

Twisted pair is the cable of choice for RS-422 networks. Twisted pair cables tend to pick up noise and other electromagnetically induced voltages as common mode signals, which are effectively rejected by the differential receivers in RS-422 ICs.

Proper termination is imperative, when using the 10Mbps or 32Mbps devices, to minimize reflections. Short networks using the 460kbps versions need not be terminated, but, terminations are recommended unless power dissipation is an overriding concern.

In point-to-point, or point-to-multipoint (multiple receivers on bus) networks, the main cable should be terminated in its characteristic impedance (typically 120Ω) at the end farthest from the driver. In multi-receiver applications, stubs connecting receivers to the main cable should be kept as short as possible.

Built-In Driver Overload Protection

The driver output stages incorporate short circuit current limiting circuitry which ensures that the output current never

exceeds the RS-422 specification. A novel design sets the short circuit current limit depending on the V_{CC} value, so unlike some competing devices, the V_{CC} = 5V short circuit current is only slightly higher than the corresponding V_{CC} = 3.3V level (see Figure 12).

In the event of a major short circuit condition, devices also include a thermal shutdown feature that disables the drivers whenever the die temperature becomes excessive. This eliminates the power dissipation, allowing the die to cool. The drivers automatically re-enable after the die temperature drops about 20°. If the fault persists, the thermal shutdown/re-enable cycle repeats until the fault is cleared.

High Temperature Operation

With T_A = +125°C and V_{CC} = 5.5V, four 100Ω differentially terminated drivers in the TSSOP package put the IC at the edge of its maximum allowed junction temperature. Using larger termination resistors, a lower maximum supply voltage, or one of the packages with a lower thermal resistance (θ_{JA}) provides more safety margin. When designing for +125°C operation, be sure to measure the application's switching current, and include this in the thermal calculations.

Low Power Shutdown Mode (ISL32179E Only)

These BiCMOS transmitters all use a fraction of the power required by their bipolar counterparts, but the QFN version includes a shutdown feature that reduces the already low quiescent I_{CC} by 90%. The ISL32179E enters shutdown (SHDN) whenever the SHDNEN pin is high and all four drivers are disabled (see "Pin Descriptions" on page 4). Note that the enable times from SHDN are longer than the enable times when the IC isn't in SHDN.

www.DataSheet4U.com

Typical Performance Curves V_{CC} = V_L = 3.3V or 5V, T_A = +25°C; Unless Otherwise Specified. V_L notes apply to the ISL32179E only.

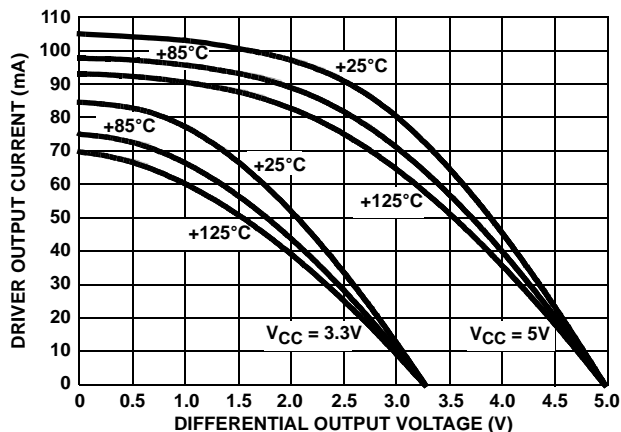

FIGURE 7. DRIVER OUTPUT CURRENT vs DIFFERENTIAL OUTPUT VOLTAGE

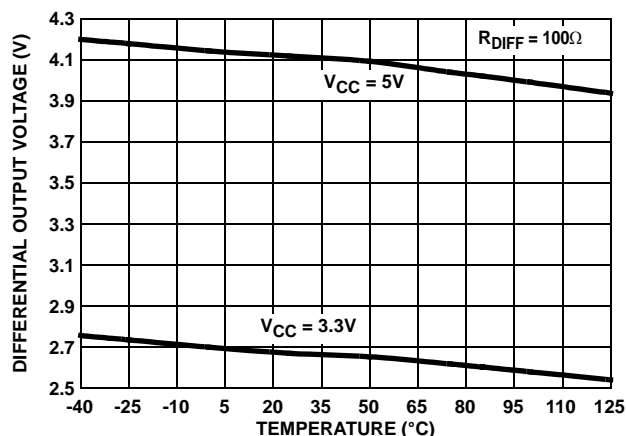

FIGURE 8. DRIVER DIFFERENTIAL OUTPUT VOLTAGE vs TEMPERATURE

Typical Performance Curves $V_{CC} = V_L = 3.3V$ or $5V$, $T_A = +25^\circ C$; Unless Otherwise Specified. V_L notes apply to the ISL32179E only. (Continued)

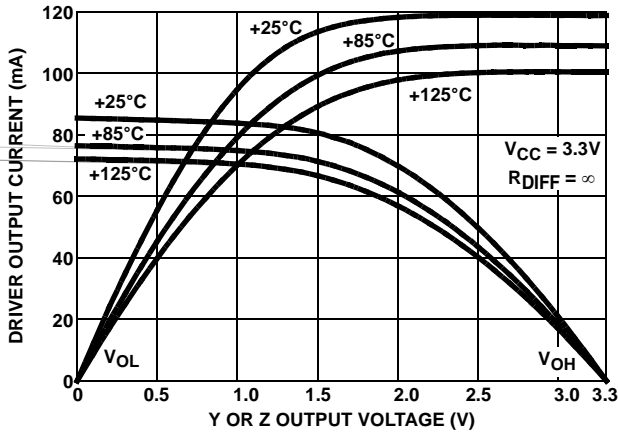

FIGURE 9. DRIVER SINGLE-ENDED (Y OR Z) OUTPUT CURRENT vs OUTPUT VOLTAGE

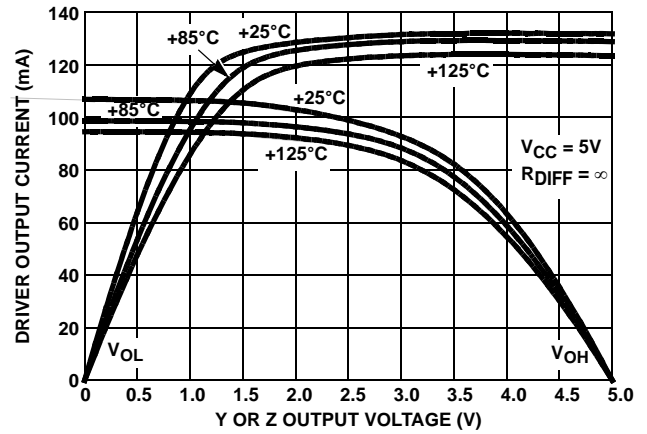

FIGURE 10. DRIVER SINGLE-ENDED (Y OR Z) OUTPUT CURRENT vs OUTPUT VOLTAGE

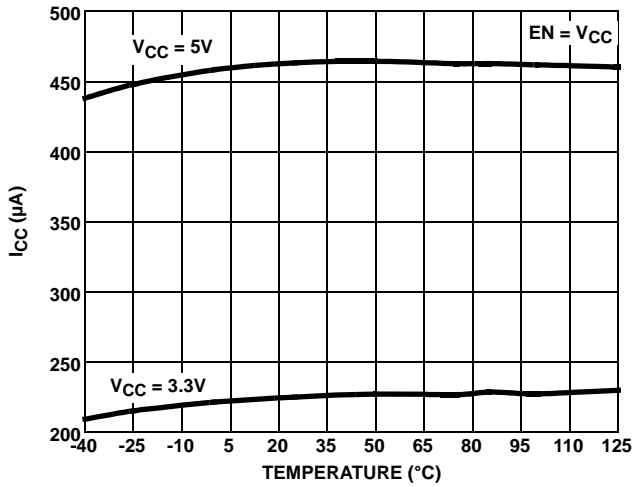

FIGURE 11. SUPPLY CURRENT vs TEMPERATURE

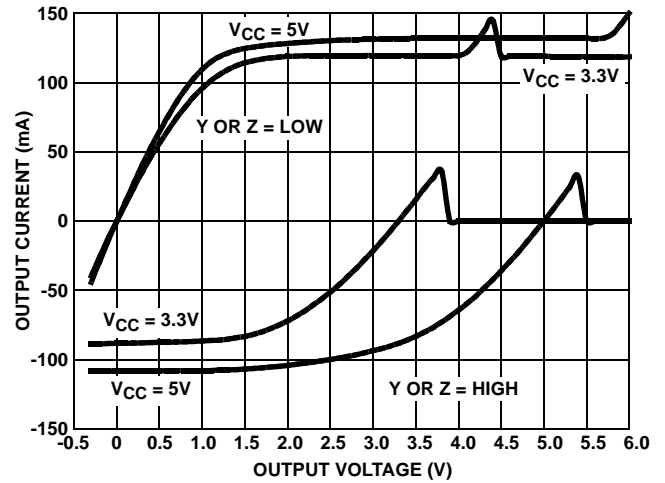

FIGURE 12. DRIVER OUTPUT CURRENT vs SHORT CIRCUIT VOLTAGE

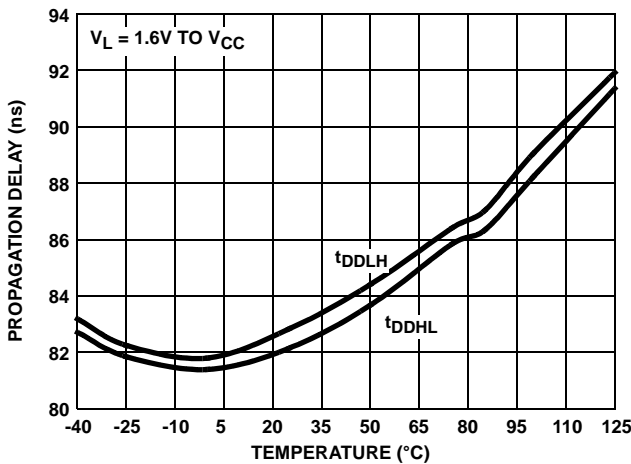

FIGURE 13. DRIVER DIFFERENTIAL PROPAGATION DELAY vs TEMPERATURE (ISL32372E, ISL32374E, ISL32179E, 460kbps OPTION)

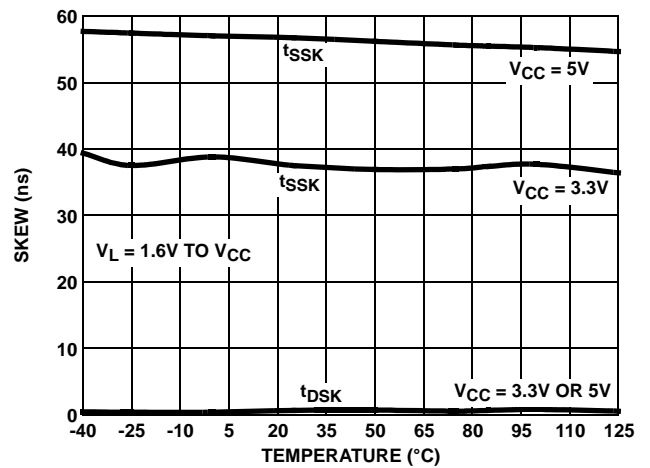

FIGURE 14. DRIVER SKEW vs TEMPERATURE (ISL32372E, ISL32374E, ISL32179E, 460kbps OPTION)

Typical Performance Curves $V_{CC} = V_L = 3.3V$ or $5V$, $T_A = +25^\circ C$; Unless Otherwise Specified. V_L notes apply to the ISL32179E only. (Continued)

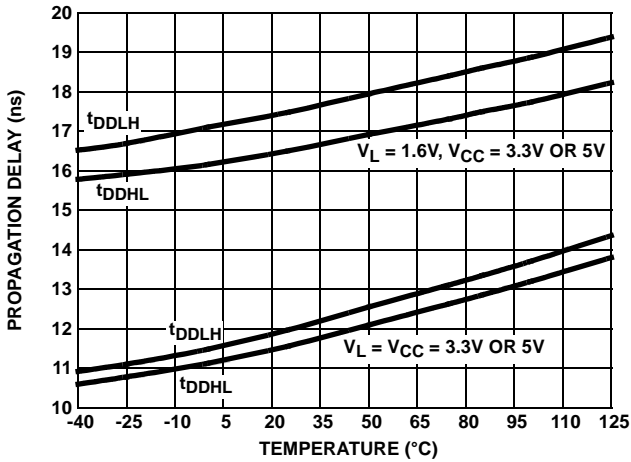

FIGURE 15. DRIVER DIFFERENTIAL PROPAGATION DELAY vs TEMPERATURE (ISL32272E, ISL32274E, ISL32179E, 10Mbps OPTION)

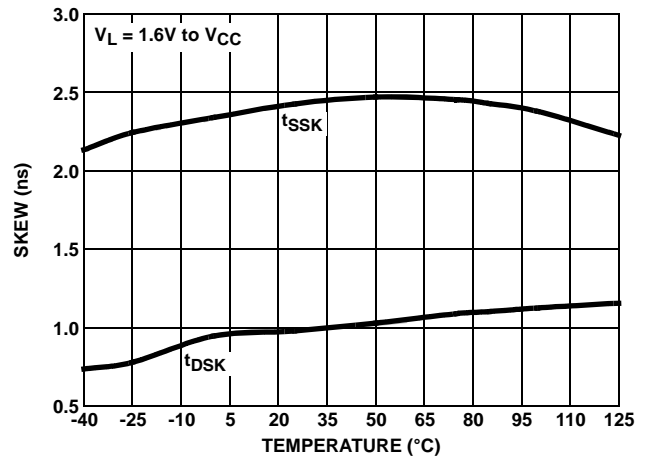

FIGURE 16. DRIVER SKEW vs TEMPERATURE (ISL32272E, ISL32274E, ISL32179E, 10Mbps OPTION)

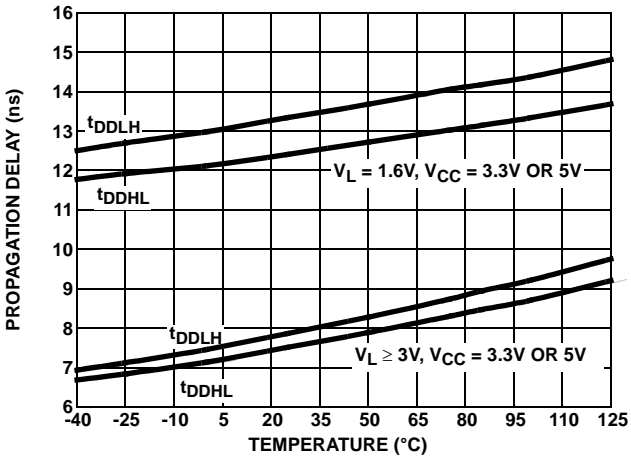

FIGURE 17. DRIVER DIFFERENTIAL PROPAGATION DELAY vs TEMPERATURE (ISL32172E, ISL32174E, ISL32179E, 32Mbps OPTION)

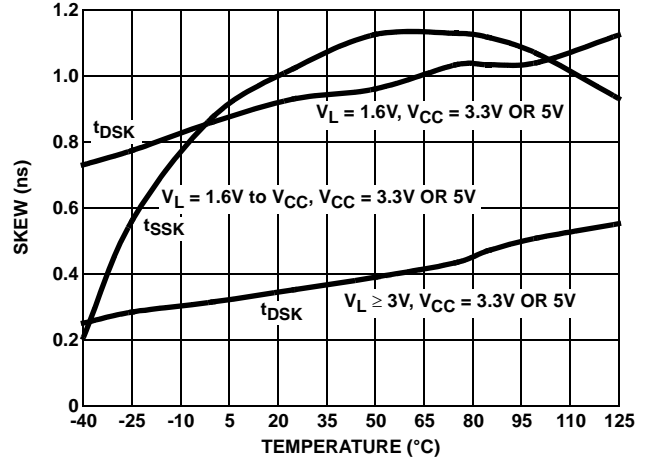

FIGURE 18. DRIVER SKEW vs TEMPERATURE (ISL32172E, ISL32174E, ISL32179E, 32Mbps OPTION)

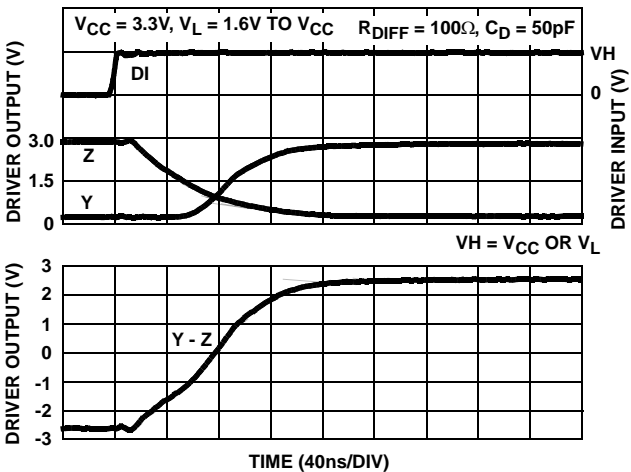

FIGURE 19. DRIVER WAVEFORMS, LOW TO HIGH (ISL32372E, ISL32374E, ISL32179E)

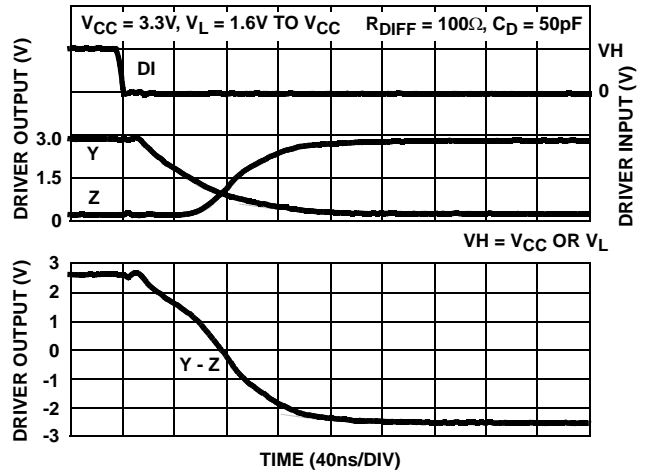

FIGURE 20. DRIVER WAVEFORMS, HIGH TO LOW (ISL32372E, ISL32374E, ISL32179E)

Typical Performance Curves $V_{CC} = V_L = 3.3V$ or $5V$, $T_A = +25^\circ C$; Unless Otherwise Specified. V_L notes apply to the ISL32179E only. (Continued)

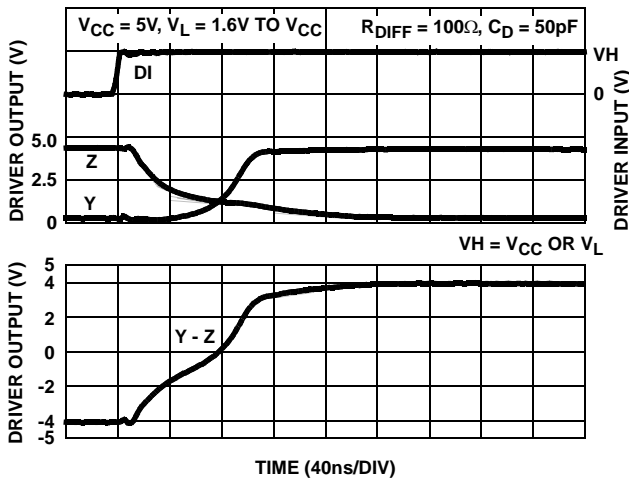

FIGURE 21. DRIVER WAVEFORMS, LOW TO HIGH (ISL32372E, ISL32374E, ISL32179E)

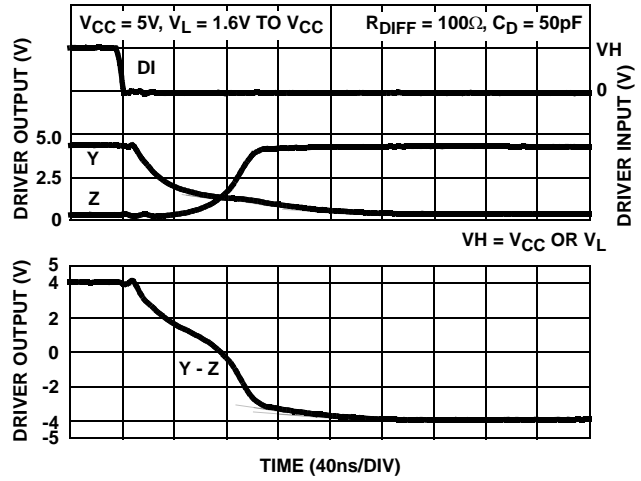

FIGURE 22. DRIVER WAVEFORMS, HIGH TO LOW (ISL32372E, ISL32374E, ISL32179E)

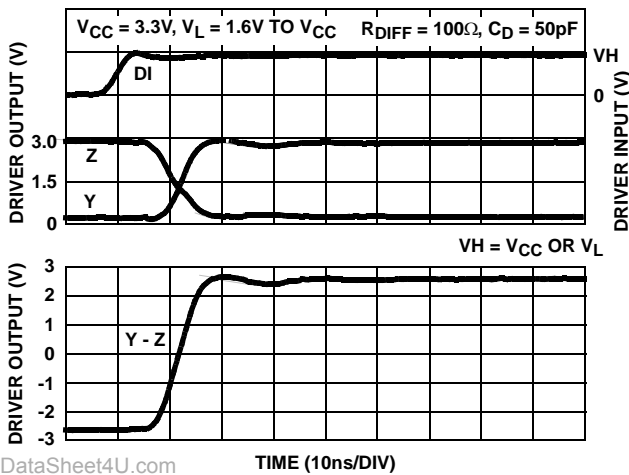

FIGURE 23. DRIVER WAVEFORMS, LOW TO HIGH (ISL32272E, ISL32274E, ISL32179E)

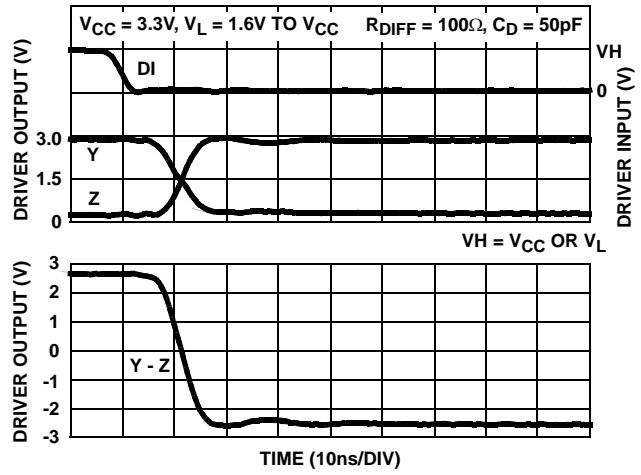

FIGURE 24. DRIVER WAVEFORMS, HIGH TO LOW (ISL32272E, ISL32274E, ISL32179E)

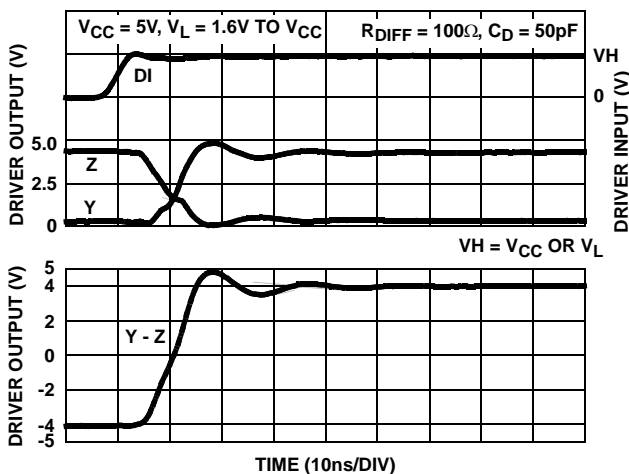

FIGURE 25. DRIVER WAVEFORMS, LOW TO HIGH (ISL32272E, ISL32274E, ISL32179E)

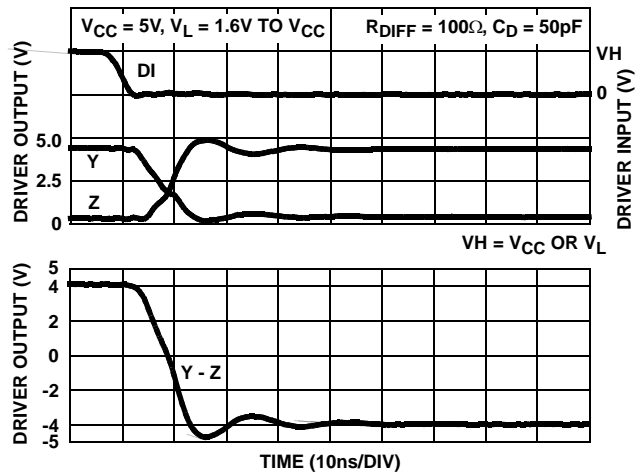

FIGURE 26. DRIVER WAVEFORMS, HIGH TO LOW (ISL32272E, ISL32274E, ISL32179E)

Typical Performance Curves $V_{CC} = V_L = 3.3V$ or $5V$, $T_A = +25^\circ C$; Unless Otherwise Specified. V_L notes apply to the ISL32179E only. (Continued)

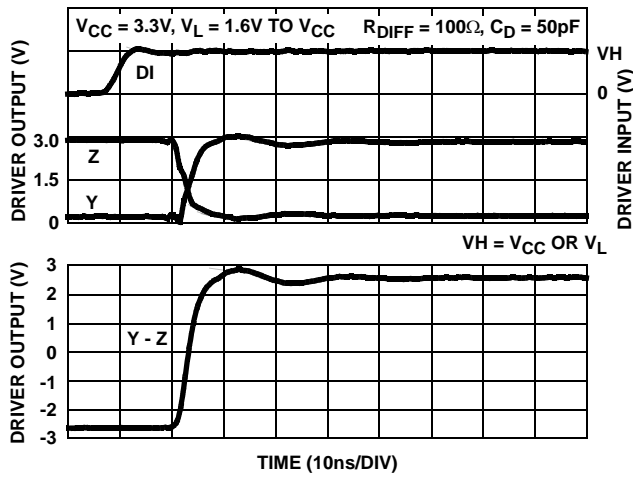

FIGURE 27. DRIVER WAVEFORMS, LOW TO HIGH (ISL32172E, ISL32174E, ISL32179E)

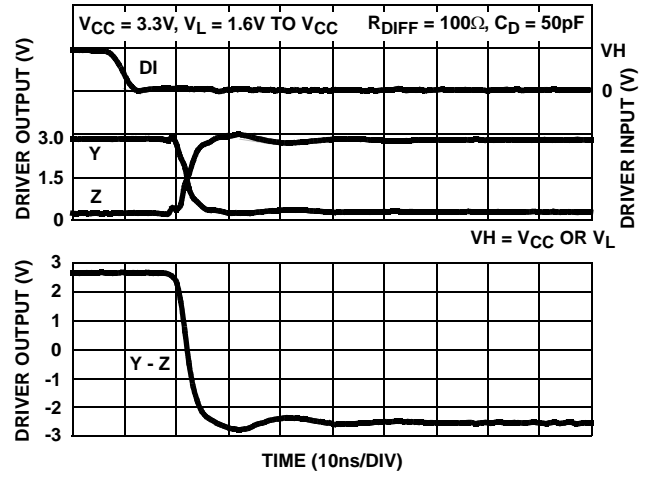

FIGURE 28. DRIVER WAVEFORMS, HIGH TO LOW (ISL32172E, ISL32174E, ISL32179E)

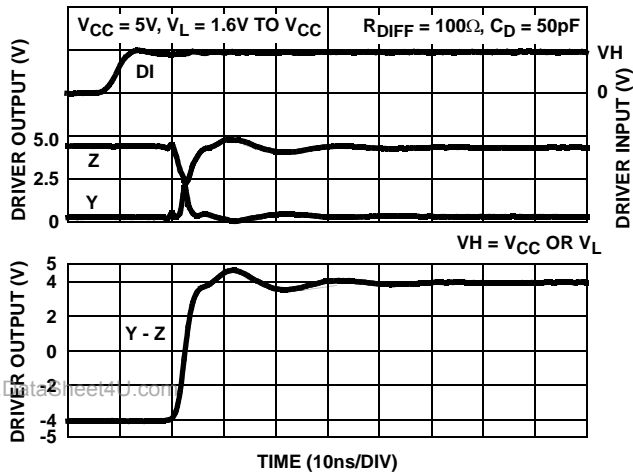

FIGURE 29. DRIVER WAVEFORMS, LOW TO HIGH (ISL32172E, ISL32174E, ISL32179E)

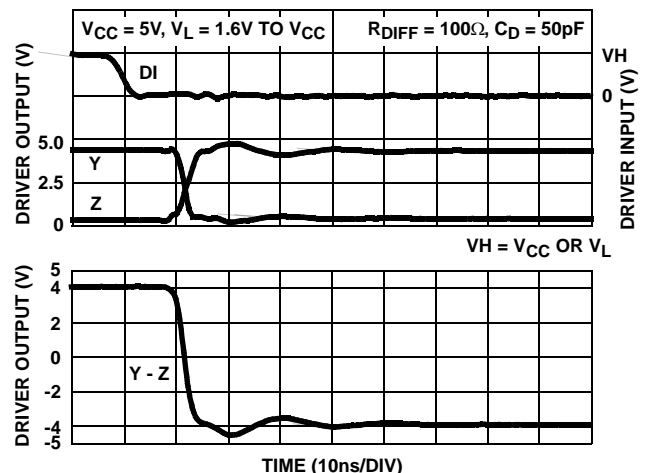

FIGURE 30. DRIVER WAVEFORMS, HIGH TO LOW (ISL32172E, ISL32174E, ISL32179E)

Typical Performance Curves $V_{CC} = V_L = 3.3V$ or $5V$, $T_A = +25^\circ C$; Unless Otherwise Specified. V_L notes apply to the ISL32179E only. (Continued)

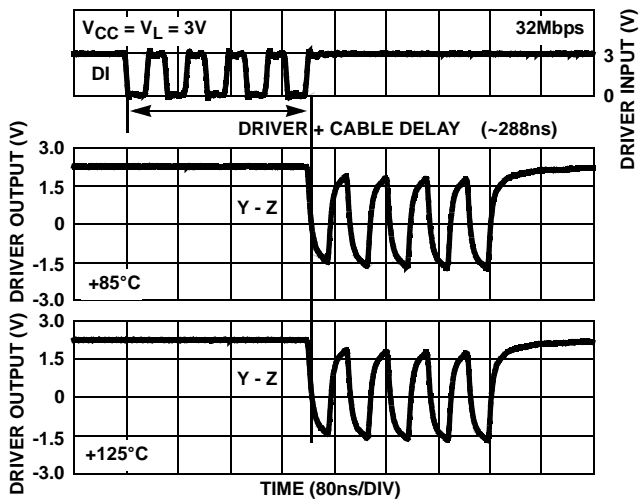

FIGURE 31. WORST CASE (NEGATIVE) FIVE PULSE DRIVER WAVEFORMS DRIVING 200 FEET (62m) OF CAT5 CABLE (SINGLE TERMINATED WITH 121Ω) (ISL32172E, ISL32174E, ISL32179E)

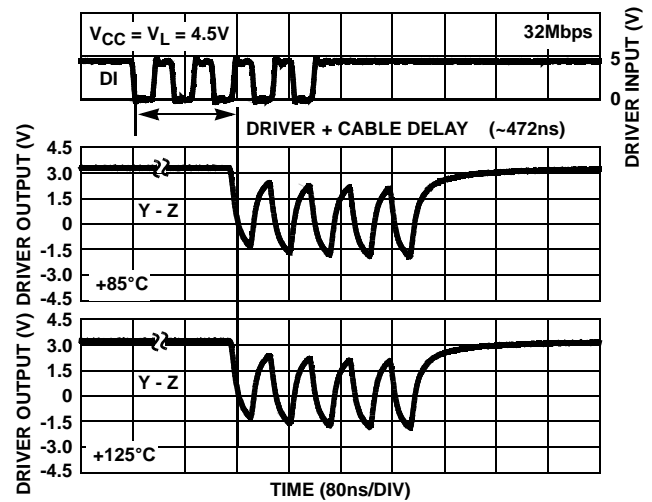

FIGURE 32. WORST CASE (NEGATIVE) FIVE PULSE DRIVER WAVEFORMS DRIVING 328 FEET (100m) OF CAT5 CABLE (SINGLE TERMINATED WITH 121Ω) (ISL32172E, ISL32174E, ISL32179E)

Die Characteristics

SUBSTRATE AND QFN THERMAL PAD POTENTIAL (POWERED UP):

GND

TRANSISTOR COUNT:

1682

PROCESS:

Si Gate BiCMOS

Small Outline Plastic Packages (SOIC)

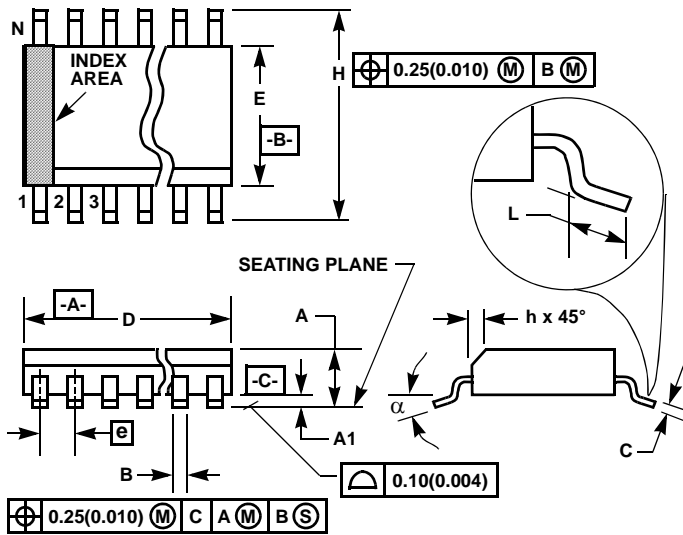

**M16.15 (JEDEC MS-012-AC ISSUE C)
16 LEAD NARROW BODY SMALL OUTLINE PLASTIC PACKAGE**

| SYMBOL | INCHES | | MILLIMETERS | | NOTES |
|--------|-----------|--------|-------------|-------|-------|
| | MIN | MAX | MIN | MAX | |
| A | 0.0532 | 0.0688 | 1.35 | 1.75 | - |
| A1 | 0.0040 | 0.0098 | 0.10 | 0.25 | - |
| B | 0.013 | 0.020 | 0.33 | 0.51 | 9 |
| C | 0.0075 | 0.0098 | 0.19 | 0.25 | - |
| D | 0.3859 | 0.3937 | 9.80 | 10.00 | 3 |
| E | 0.1497 | 0.1574 | 3.80 | 4.00 | 4 |
| e | 0.050 BSC | | 1.27 BSC | | - |
| H | 0.2284 | 0.2440 | 5.80 | 6.20 | - |
| h | 0.0099 | 0.0196 | 0.25 | 0.50 | 5 |
| L | 0.016 | 0.050 | 0.40 | 1.27 | 6 |
| N | 16 | | 16 | | 7 |
| α | 0° | 8° | 0° | 8° | - |

NOTES:

1. Symbols are defined in the "MO Series Symbol List" in Section 2.2 of Publication Number 95.
2. Dimensioning and tolerancing per ANSI Y14.5M-1982.
3. Dimension "D" does not include mold flash, protrusions or gate burrs. Mold flash, protrusion and gate burrs shall not exceed 0.15mm (0.006 inch) per side.
4. Dimension "E" does not include interlead flash or protrusions. Interlead flash and protrusions shall not exceed 0.25mm (0.010 inch) per side.
5. The chamfer on the body is optional. If it is not present, a visual index feature must be located within the crosshatched area.
6. "L" is the length of terminal for soldering to a substrate.
7. "N" is the number of terminal positions.
8. Terminal numbers are shown for reference only.
9. The lead width "B", as measured 0.36mm (0.014 inch) or greater above the seating plane, shall not exceed a maximum value of 0.61mm (0.024 inch).
10. Controlling dimension: MILLIMETER. Converted inch dimensions are not necessarily exact.

Rev. 1 6/05

Thin Shrink Small Outline Package Family (TSSOP)

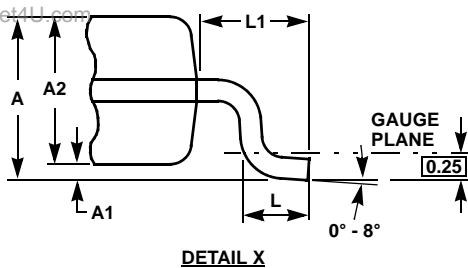
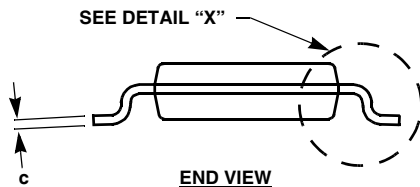
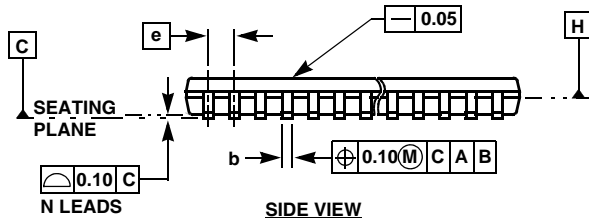
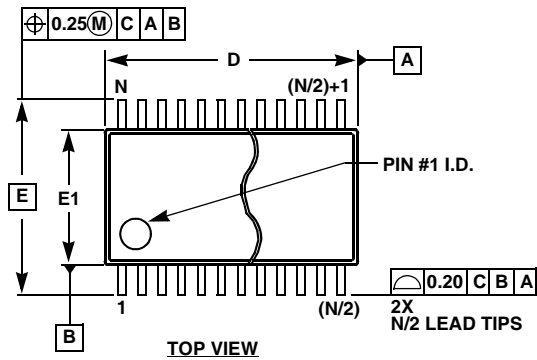

MDP0044

THIN SHRINK SMALL OUTLINE PACKAGE FAMILY

| SYMBOL | MILLIMETERS | | | | | TOLERANCE |
|--------|-------------|-------|-------|-------|-------|-------------|
| | 14 LD | 16 LD | 20 LD | 24 LD | 28 LD | |
| A | 1.20 | 1.20 | 1.20 | 1.20 | 1.20 | Max |
| A1 | 0.10 | 0.10 | 0.10 | 0.10 | 0.10 | ±0.05 |
| A2 | 0.90 | 0.90 | 0.90 | 0.90 | 0.90 | ±0.05 |
| b | 0.25 | 0.25 | 0.25 | 0.25 | 0.25 | +0.05/-0.06 |
| c | 0.15 | 0.15 | 0.15 | 0.15 | 0.15 | +0.05/-0.06 |
| D | 5.00 | 5.00 | 6.50 | 7.80 | 9.70 | ±0.10 |
| E | 6.40 | 6.40 | 6.40 | 6.40 | 6.40 | Basic |
| E1 | 4.40 | 4.40 | 4.40 | 4.40 | 4.40 | ±0.10 |
| e | 0.65 | 0.65 | 0.65 | 0.65 | 0.65 | Basic |
| L | 0.60 | 0.60 | 0.60 | 0.60 | 0.60 | ±0.15 |
| L1 | 1.00 | 1.00 | 1.00 | 1.00 | 1.00 | Reference |

Rev. F 2/07

NOTES:

1. Dimension "D" does not include mold flash, protrusions or gate burrs. Mold flash, protrusions or gate burrs shall not exceed 0.15mm per side.
2. Dimension "E1" does not include interlead flash or protrusions. Interlead flash and protrusions shall not exceed 0.25mm per side.
3. Dimensions "D" and "E1" are measured at dAtum Plane H.
4. Dimensioning and tolerancing per ASME Y14.5M-1994.

All Intersil U.S. products are manufactured, assembled and tested utilizing ISO9000 quality systems.

Intersil Corporation's quality certifications can be viewed at www.intersil.com/design/quality

Intersil products are sold by description only. Intersil Corporation reserves the right to make changes in circuit design, software and/or specifications at any time without notice. Accordingly, the reader is cautioned to verify that data sheets are current before placing orders. Information furnished by Intersil is believed to be accurate and reliable. However, no responsibility is assumed by Intersil or its subsidiaries for its use; nor for any infringements of patents or other rights of third parties which may result from its use. No license is granted by implication or otherwise under any patent or patent rights of Intersil or its subsidiaries.

For information regarding Intersil Corporation and its products, see www.intersil.com