

---

# Subminiature High Performance TSAIGaAs Red LED Lamps

## Technical Data

**HLMP-P106/P156**  
**HLMP-Q102/Q152**  
**HLMP-Q106/Q156**

---

### Features

- **Subminiature Flat Top Package**  
Ideal for Backlighting and Light Piping Applications
- **Subminiature Dome Package**  
Diffused Dome for Wide Viewing Angle  
Non-diffused Dome for High Brightness
- **Wide Range of Drive Currents**  
500  $\mu$ A to 50 mA
- **Ideal for Space Limited Applications**
- **Axial Leads**
- **Available with lead configurations for Surface Mount and Through Hole PC Board Mounting**

### Description

#### Flat Top Package

The HLMP-PXXX Series flat top lamps use an untinted, non-diffused, truncated lens to provide a wide radiation pattern that is necessary for use in backlighting applications. The flat top lamps are also ideal for use as emitters in light pipe applications.

### Dome Packages

The HLMP-QXXX Series dome lamps, for use as indicators, use a tinted, diffused lens to provide a wide viewing angle with high on-off contrast ratio. High brightness lamps use an untinted, nondiffused lens to provide a high luminous intensity within a narrow radiation pattern.

### Lead Configurations

All of these devices are made by encapsulating LED chips on axial lead frames to form molded epoxy subminiature lamp packages. A variety of package configuration options is available. These include special surface mount lead configurations, gull wing, yoke lead, or Z-bend. Right angle lead bends at 2.54 mm (0.100 inch) and 5.08 mm (0.200 inch) center spacing are available for through hole mounting. For more information refer to Standard SMT and Through Hole Lead Bend Options for Subminiature LED Lamps data sheet.



### Technology

These subminiature solid state lamps utilize a highly optimized LED material technology, transparent substrate aluminum gallium arsenide (TSAIGaAs). This LED technology has a very high luminous efficiency, capable of producing high light output over a wide range of drive currents (500  $\mu$ A to 50 mA). The color is deep red at a dominant wavelength of 644 nm deep red. TSAIGaAs is a flip-chip LED technology, die attached to the anode lead and wire bonded to the cathode lead. Available viewing angles are 75°, 35°, and 15°.

## Device Selection Guide

Package Description	Viewing Angle $2 \theta_{1/2}$	Deep Red $R_d = 644 \text{ nm}$	Typical Iv $I_f = 500 \mu\text{a}$	Typical Iv $I_f = 20 \text{ mA}$	Package Outline
Domed, Diffused Tinted, Standard Current	35	HLMP-Q102		100	B
Domed, Diffused Tinted, Low Current	35	HLMP-Q152	2		B
Domed, Nondiffused Untinted, Standard Current	15	HLMP-Q106		400	B
Domed, Nondiffused Untinted, Low Current	15	HLMP-Q156	7		B
Flat Top, Nondiffused, Untinted, Standard Current	75	HLMP-P106		130	A
Flat Top, Nondiffused Untinted, Low Current	75	HLMP-P156	2		A

## Ordering Information

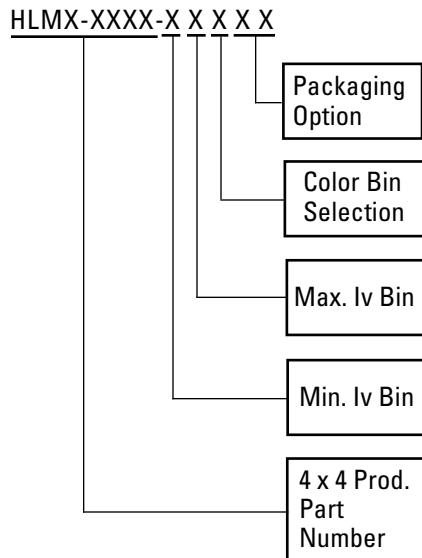

## Package Dimensions

### A) Flat Top Lamps

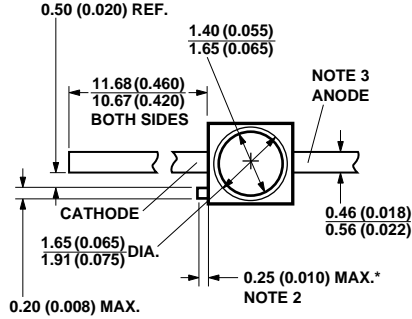

\* REFER TO FIGURE 1 FOR DESIGN CONCERNS.

### B) Diffused and Nondiffused Dome Lamps

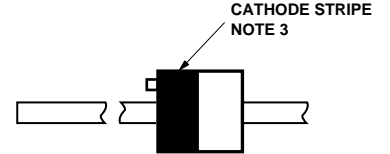
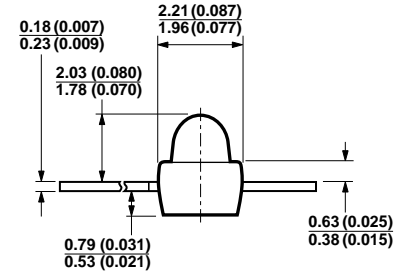
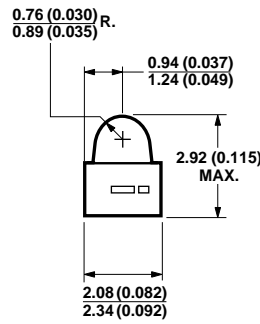
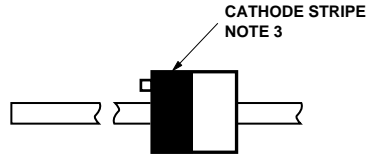
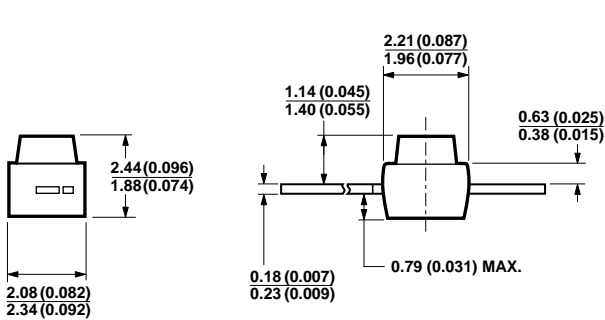
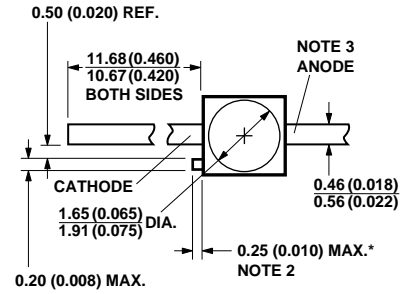

**NOTES:**

1. ALL DIMENSIONS ARE IN MILLIMETRES (INCHES).
2. PROTRUDING SUPPORT TAB IS CONNECTED TO ANODE LEAD.
3. LEAD POLARITY FOR THESE TS AlGaAs SUBMINIATURE LAMPS IS OPPOSITE TO THE LEAD POLARITY OF SUBMINIATURE LAMPS USING OTHER LED TECHNOLOGIES.

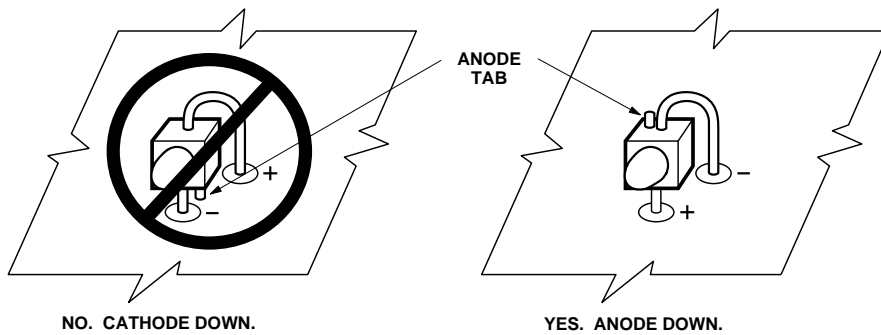

**Figure 1. Proper Right Angle Mounting to a PC Board to Prevent Protruding Anode Tab from Shorting to Cathode Connection.**

## Absolute Maximum Ratings at $T_A = 25^\circ\text{C}$

Peak Forward Current <sup>[2]</sup> .....	300 mA
Average Forward Current (@ $I_{PEAK} = 300\text{ mA}$ ) <sup>[1,2]</sup> .....	30 mA
DC Forward Current <sup>[3]</sup> .....	50 mA
Power Dissipation .....	100 mW
Reverse Voltage ( $I_R = 100\ \mu\text{A}$ ) .....	5 V
Transient Forward Current (10 $\mu\text{s}$ Pulse) <sup>[4]</sup> .....	500 mA
Operating Temperature Range .....	-55 to +100°C
Storage Temperature Range .....	-55 to +100°C
LED Junction Temperature .....	110°C
Lead Soldering Temperature	
[1.6 mm (0.063 in.) from body] .....	260°C for 5 seconds
Reflow Soldering Temperatures	
Convective IR .....	235°C Peak, above 183°C for 90 seconds
Vapor Phase .....	215°C for 3 minutes

### Notes:

1. Maximum  $I_{AVG}$  at  $f = 1\text{ kHz}$ ,  $DF = 10\%$ .
2. Refer to Figure 7 to establish pulsed operating conditions.
3. Derate linearly as shown in Figure 6.
4. The transient peak current is the maximum non-recurring peak current the device can withstand without damaging the LED die and wire bonds. It is not recommended that the device be operated at peak currents above the Absolute Maximum Peak Forward Current.

## Optical Characteristics at $T_A = 25^\circ\text{C}$

Part Number HLMP-	Luminous Intensity $I_V$ (mcd) @ 20 mA <sup>[1]</sup>		Total Flux $\phi_V$ (mlm) @ 20 mA <sup>[2]</sup> Typ.	Peak Wavelength $\lambda_{peak}$ (nm) Typ.	Color, Dominant Wavelength $\lambda_d$ <sup>[3]</sup> (nm) Typ.	Viewing Angle $2\theta^{1/2}$ Degrees <sup>[4]</sup> Typ.	Luminous Efficacy $\eta_V$ <sup>[5]</sup> (lm/w)
	Min.	Typ.					
Q106-R00xx	100	400	280	654	644	15	85
Q102-N00xx	25	100	-	654	644	35	85
P106-Q00xx	63	130	280	654	644	75	85

## Optical Characteristics at $T_A = 25^\circ\text{C}$

Part Number (Low Current) HLMP-	Luminous Intensity $I_V$ (mcd) @ 0.5 mA <sup>[1]</sup>		Total Flux $\phi_V$ (mlm) @ 0.5 mA <sup>[2]</sup> Typ.	Peak Wavelength $\lambda_{peak}$ (nm) Typ.	Color, Dominant Wavelength $\lambda_d$ <sup>[3]</sup> (nm) Typ.	Viewing Angle $2\theta^{1/2}$ Degrees <sup>[4]</sup> Typ.	Luminous Efficacy $\eta_V$ <sup>[5]</sup> (lm/w)
	Min.	Typ.					
Q156-H00xx	2.5	7	10.5	654	644	15	85
Q152-G00xx	1.6	2	-	654	644	35	85
P156-EG0xx	0.63	2	10.5	654	644	75	85

### Notes:

1. The luminous intensity,  $I_V$ , is measured at the mechanical axis of the lamp package. The actual peak of the spatial radiation pattern may not be aligned with this axis.
2.  $\phi_V$  is the total luminous flux output as measured with an integrating sphere.
3. The dominant wavelength,  $\lambda_d$ , is derived from the CIE Chromaticity Diagram and represents the color of the device.
4.  $\theta^{1/2}$  is the off-axis angle where the luminous intensity is 1/2 the peak intensity.
5. Radiant intensity,  $I_V$ , in watts/steradian, may be calculated from the equation  $I_V = I_V/\eta_V$ , where  $I_V$  is the luminous intensity in candelas and  $\eta_V$  is the luminous efficacy in lumens/watt.

### Electrical Characteristics at $T_A = 25^\circ\text{C}$

Part Number HLMP-	Forward Voltage $V_F$ (Volts) @ $I_F = 20\text{ mA}$		Reverse Breakdown $V_R$ (Volts) @ $I_R = 100\ \mu\text{A}$		Capacitance $C$ (pF) $V_F = 0$ , $f = 1\text{ MHz}$ Typ.	Thermal Resistance $R\theta_{J-PIN}$ ( $^\circ\text{C/W}$ )	Speed of Response $\tau_s$ (ns) Time Constant $e^{-t/\tau_s}$ Typ.
	Typ.	Max.	Min.	Typ.			
Q106	1.9	2.4	5	20	20	170	45
Q102	1.9	2.4	5	20	20	170	45
P106	1.9	2.4	5	20	20	170	45

### Electrical Characteristics at $T_A = 25^\circ\text{C}$

Part Number (Low Current) HLMP-	Forward Voltage $V_F$ (Volts) @ $I_F = 0.5\text{ mA}$		Reverse Breakdown $V_R$ (Volts) @ $I_R = 100\ \mu\text{A}$		Capacitance $C$ (pF) $V_F = 0$ , $f = 1\text{ MHz}$ Typ.	Thermal Resistance $R\theta_{J-PIN}$ ( $^\circ\text{C/W}$ )	Speed of Response $\tau_s$ (ns) Time Constant $e^{-t/\tau_s}$ Typ.
	Typ.	Max.	Min.	Typ.			
Q156	1.6	1.9	5	20	20	170	45
Q152	1.6	1.9	5	20	20	170	45
P156	1.6	1.9	5	20	20	170	45

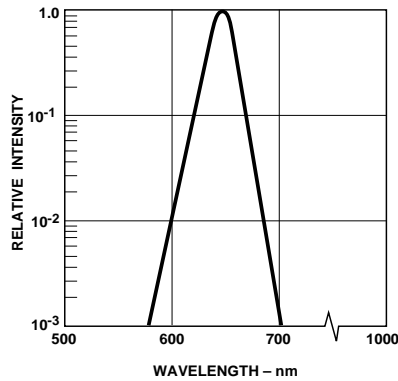

Figure 2. Relative Intensity vs. Wavelength.

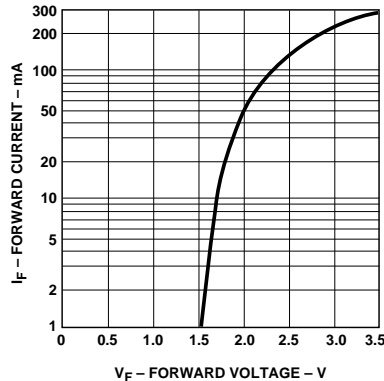

Figure 3. Forward Current vs. Forward Voltage.

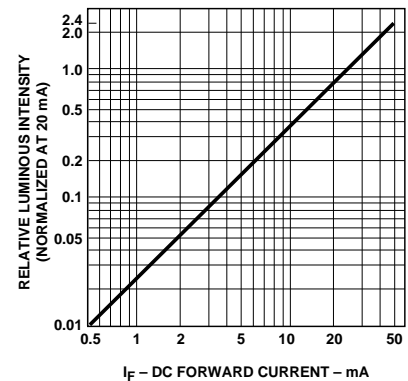

Figure 4. Relative Luminous Intensity vs. DC Forward Current.

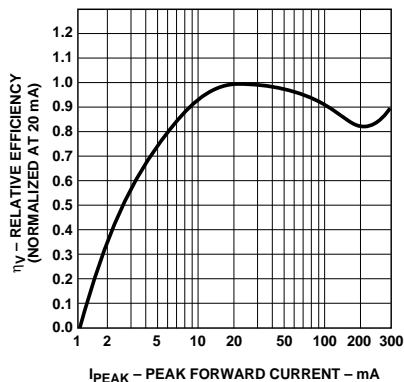

Figure 5. Relative Efficiency vs. Peak Forward Current.

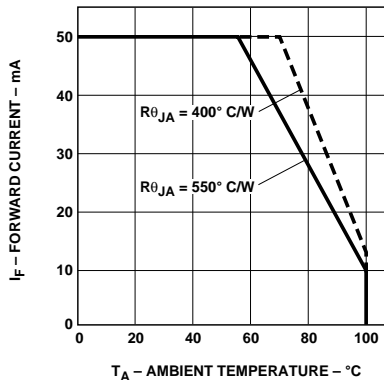

Figure 6. Maximum Forward DC Current vs. Ambient Temperature. Derating Based on  $T_{JMAX} = 110^\circ\text{C}$ .

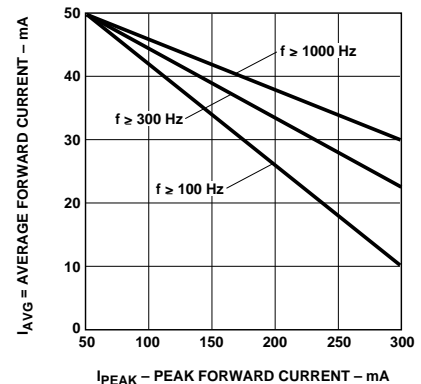

Figure 7. Maximum Average Current vs. Peak Forward Current.

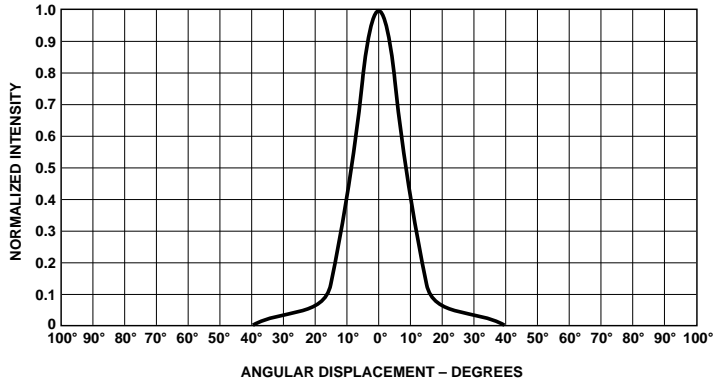

Figure 8. HLMP-Q106/-Q156.

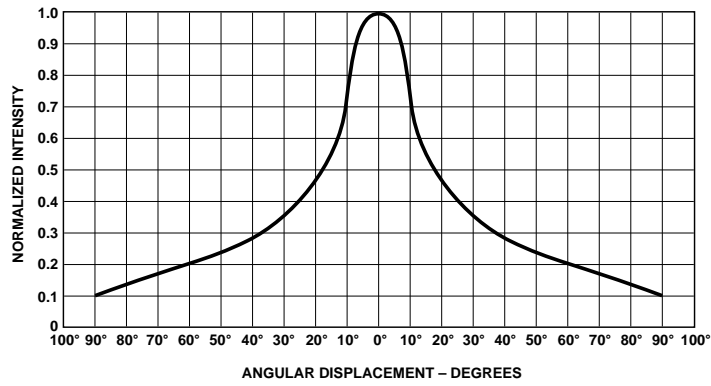

Figure 9. HLMP-Q102/-Q152

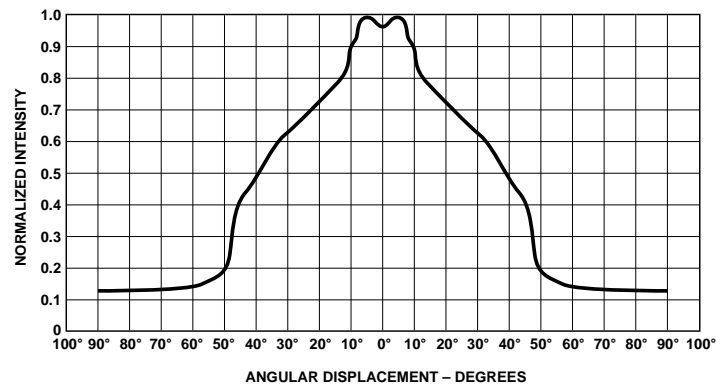

Figure 10. HLMP-P106/-P156.

### Intensity Bin limits

Bin	Min.	Max.
E	0.63	1.25
F	1.00	2.00
G	1.60	3.20
H	2.50	5.00
J	4.00	8.00
K	6.30	12.50
L	10.00	20.00
M	16.00	32.00
N	25.00	50.00
P	40.00	80.00
Q	63.00	125.00
R	100.00	200.00
S	160.00	320.00
T	250.00	500.00
U	400.00	800.00
V	630.00	1250.00
W	1000.00	2000.00
X	1600.00	3200.00
Y	2500.00	5000.00

### Color Bin limits

Package	Bin	Min.	Max.
Red	0	Full Distribution	

### Mechanical Option

00	Straight Leads, Bulk Packaging, Quantity of 500 Parts
11	Gull Wing Leads, 12 mm Tape on 7 in. Dia. Reel, 1500 Parts per Reel
12	Gull Wing Lead, Bulk Packaging, Quantity of 500 Parts
14	Gull Wing Leads, 12 mm Tape on 13 in. Dia. Reel, 6000 Parts per Reel
21	Yoke Leads, 12 mm Tape on 7 in. Dia. Reel, 1500 Parts per Reel
22	Yoke Leads, Bulk Packaging, Quantity of 500 Parts
24	Yoke Leads, 12 mm Tape on 13 in. Dia. Reel, 6000 Parts per Reel
31	Z-Bend Leads, 12 mm Tape on 7 in. Dia. Reel, 1500 Parts per Reel
32	Z-Bend Leads, Bulk Packaging, Quantity of 500 Parts
34	Z-Bend Leads, 12 mm Tape on 13 in. Dia. Reel, 6000 Parts per Reel

**Note:**

All Categories are established for classification of products. Products may not be available in all categories. Please contact your local Agilent representative for further clarification/information.

*[www.semiconductor.agilent.com](http://www.semiconductor.agilent.com)*

Data subject to change.  
Copyright © 2001 Agilent Technologies, Inc.  
June 4, 2001  
Obsoletes 5968-5431E (2/99)  
5980-2437E