



**128K × 32/36 synchronous SRAM**

**Advance information**

**Features**

- Organization: 131,072 words × 32 or 36 bits
- Fast clock speeds to 166 MHz in LVTTTL/LVCMOS
- Fast clock to data access: 3.5/3.8/4/5 ns
- Fast OE access time: 3.5/3.5/3.8/4 ns
- Fully synchronous register-to-register operation
- Single register 'flow-through' mode
- Single cycle de-select
- Pentium® compatible architecture and timing
- Synchronous and asynchronous output enable control
- Economical 100-pin TQFP package
- Byte write enables
- Clock enable for operation hold
- Multiple chip enables for easy expansion
- 3.3 core power supply
- 2.5V or 3.3V I/O operation with separate V<sub>DDQ</sub>
- Automatic power down: 10 mW typical standby power
- NTD™ pipeline architecture available (AS7C3128KNTD32/36)

**Logic block diagram**

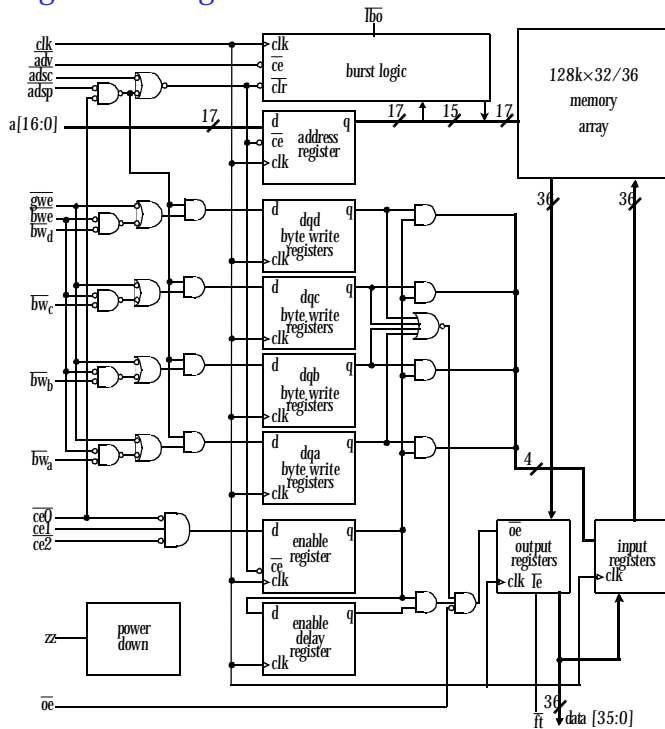

**Pin arrangement**

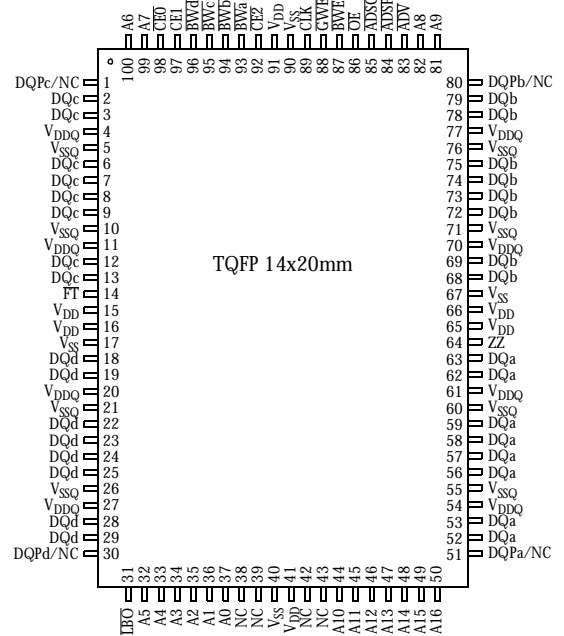

Note: Pins 1,30,51,80 are NC for ×32

**Selection guide**

AS7C3128PFS32/36A AS7C3128PFS32/36A AS7C3128PFS32/36A AS7C3128PFS32/36A

	3.5	-3.8	-4	-5	Units
Minimum cycle time	6	6.7	7.5	10	ns
Maximum clock frequency	166.7	150	133.3	100	MHz
Maximum pipelined clock access time	3.5	3.8	4	5	ns
Maximum operating current	350	325	300	250	mA
Maximum standby current	60	60	60	60	mA
Maximum CMOS standby current (DC)	5	5	5	5	mA



## Functional description

The AS7C37C3128PFS32/36A family is a high performance CMOS 4 Mbit synchronous Static Random Access Memory (SRAM) organized as 131,072 words  $\times$  32 or 36 bits and incorporates a two stage register-register pipeline for highest frequency on any given technology.

Timing for this device is compatible with existing Pentium synchronous cache specifications. This architecture is suited for ASIC, DSP (TMS320C6X), and PowerPC based systems in computing, datcomm, instrumentation, and telecommunications systems. When using pipeline burst SRAMs, any turnaround from read-to-write and write-to-read, required the insertion of two dead cycles. When reading data, a two cycle latency until data valid exists due to the nature of the dual register architecture. When writing, data, address and controls are all presented simultaneously. Therefore two dead cycles are required to clear the read pipeline before a write can occur. In a write-to-read transition, two dead cycles are again produced due to the pipeline read latency. These penalties are eliminated in the AS7C3128KNTD32/36 architecture device.

Fast cycle times of 6/6.7/7.5/10 ns with clock access times ( $t_{CD}$ ) of 3.5/3.5/3.8/4 ns enable 167, 150, 133 and 100 MHz bus frequencies. Three chip enable inputs permit easy memory expansion. Burst operation is initiated in one of two ways: the controller address strobe ( $\overline{ADSC}$ ), or the processor address strobe ( $\overline{ADSP}$ ). The burst advance pin ( $\overline{ADV}$ ) allows subsequent internally generated burst addresses.

Read cycles are initiated with  $\overline{ADSP}$  (regardless of  $\overline{WE}$  and  $\overline{ADSC}$ ) using the new external address clocked into the on-chip address register when  $\overline{ADSP}$  is sampled Low, the chip enables are sampled active, and the output buffer is enabled with  $\overline{OE}$ . In a read operation the data accessed by the current address, registered in the address registers by the positive edge of CLK, are carried to the data-out registers and driven on the output pins on the next positive edge of CLK.  $\overline{ADV}$  is ignored on the clock edge that samples  $\overline{ADSP}$  asserted, but is sampled on all subsequent clock edges. Address is incremented internally for the next access of the burst when  $\overline{WE}$  is sampled High,  $\overline{ADV}$  is sampled Low, and both address strobes are High. Burst operation is selectable with the MODE input. With MODE unconnected or driven High, burst operations use a Pentium count sequence. With MODE driven LOW the device uses a linear count sequence, suitable for PowerPC and many other applications.

Write cycles are performed by disabling the output buffers with  $\overline{OE}$  and asserting a write command. A global write enable  $\overline{GWE}$  writes all 32 bits regardless of the state of individual  $BW[a:d]$  inputs. Alternately, when  $\overline{GWE}$  is High, one or more bytes may be written by asserting  $\overline{BWE}$  and the appropriate individual byte  $BW$  signal(s).

$\overline{BWn}$  is ignored on the clock edge that samples  $\overline{ADSP}$  Low, but is sampled on all subsequent clock edges. Output buffers are disabled when  $\overline{BWn}$  is sampled LOW (regardless of  $\overline{OE}$ ). Data is clocked into the data input register when  $\overline{BWn}$  is sampled Low. Address is incremented internally to the next burst of address if  $\overline{BWn}$  and  $\overline{ADV}$  are sampled Low.

Read or write cycles may also be initiated with  $\overline{ADSC}$  instead of  $\overline{ADSP}$ . The differences between cycles initiated with  $\overline{ADSC}$  and  $\overline{ADSP}$  follow.

- $\overline{ADSP}$  must be sampled HIGH when  $\overline{ADSC}$  is sampled LOW to initiate a cycle with  $\overline{ADSC}$ .
- $\overline{WE}$  signals are sampled on the clock edge that samples  $\overline{ADSC}$  LOW (and  $\overline{ADSP}$  High).
- Master chip select  $\overline{CE0}$  blocks  $\overline{ADSP}$ , but not  $\overline{ADSC}$ .

The AS7C3128K36P family operates from a 3.3V supply. I/O's use a separate power supply that can operate at 2.5V or 3.3V. This device is available in a 100-pin 14 $\times$ 20 mm TQFP package.

## Capacitance

Parameter	Symbol	Signals	Test conditions	Max	Unit
Input capacitance	$C_{IN}$	Address and control pins	$V_{in} = 0V$	5	pF
I/O capacitance	$C_{I/O}$	I/O pins	$V_{in} = V_{out} = 0V$	7	pF

## Write enable truth table (per byte)

$\overline{GWE}$	$\overline{BWE}$	$\overline{BWn}$	$\overline{WRITE_n}$
L	X	X	T
X	L	L	T
H	H	X	F
H	L	H	F <sup>†</sup>

**Key:** X = Don't Care, L = Low, H = High.

<sup>†</sup> Valid read.



## Signal descriptions

Signal	I/O	Properties	Description
CLK	I	CLOCK	Clock. All inputs except $\overline{OE}$ are synchronous to this clock.
A0–A16	I	SYNC	Address. Sampled when all chip enables are active and $\overline{ADSC}$ or $\overline{ADSP}$ are asserted.
DQ[a,b,c,d]	I/O	SYNC	Data. Driven as output when the chip is enabled and $\overline{OE}$ is active.
$\overline{CE0}$	I	SYNC	Master chip enable. Sampled on clock edges when $\overline{ADSP}$ or $\overline{ADSC}$ is active. When $\overline{CE0}$ is inactive, $\overline{ADSP}$ is blocked. Refer to the SYNCHRONOUS TRUTH TABLE for more information.
$\overline{CE1}$ , $\overline{CE2}$	I	SYNC	Synchronous chip enables. Active HIGH and active Low, respectively. Sampled on clock edges when $\overline{ADSC}$ is active or when $\overline{CE1}$ and $\overline{ADSP}$ are active.
$\overline{ADSP}$	I	SYNC	Address strobe processor. Asserted LOW to load a new bus address or to enter standby mode.
$\overline{ADSC}$	I	SYNC	Address strobe controller. Asserted LOW to load a new address or to enter standby mode.
$\overline{ADV}$	I	SYNC	Advance. Asserted LOW to continue burst read/write.
$\overline{GWE}$	I	SYNC default = HIGH	Global write enable. Asserted LOW to write all 36 bits. When High, $\overline{BWE}$ and $\overline{WE0-WE3}$ control write enable. <i>This signal is internally pulled High.</i>
$\overline{BWE}$	I	SYNC default = LOW	Byte write enable. Asserted LOW with $\overline{GWE} = \text{HIGH}$ to enable effect of $\overline{WE0-WE3}$ inputs. <i>This signal is internally pulled Low.</i>
$\overline{BW[a,b,c,d]}$	I	SYNC	Write enables. Used to control write of individual bytes when $\overline{GWE} = \text{HIGH}$ and $\overline{BWE} = \text{Low}$ . If any of $\overline{BW[a:d]}$ is active with $\overline{GWE} = \text{HIGH}$ and $\overline{BWE} = \text{LOW}$ the cycle is a write cycle. If all $\overline{BW[a:d]}$ are inactive the cycle is a read cycle.
$\overline{OE}$	I	ASYNCR	Asynchronous output enable. I/O pins are driven when $\overline{OE}$ is active and the chip is synchronously enabled.
$\overline{LBO}$	I	STATIC default = HIGH	Count mode. When driven High, count sequence follows Intel XOR convention. When driven Low, count sequence follows linear convention. <i>This signal is internally pulled High.</i> <sup>18</sup>
$\overline{FT}$	I	STATIC	Flow-through mode. When low, enables single register flow-through mode. Connect to $V_{DD}$ if unused or for pipelined operation.
$\overline{ZZ}$	I	ASYNCR	Sleep. Places device in low power mode; data is retained. Connect to GND if unused.

## Absolute maximum ratings

Parameter	Symbol	Min	Max	Unit
Power supply voltage relative to GND	$V_{DD}$ , $V_{DDQ}$	-0.5	+4.6	V
Input voltage relative to GND (input pins)	$V_{IN}$	-0.5	+4.6	V
Input voltage relative to GND (I/O pins)	$V_{IN}$	-0.5	$V_{DDQ} + 0.5$	V
Power dissipation	$P_D$	–	1.2	W
DC output current	$I_{OUT}$	–	30	mA
Storage temperature (plastic)	$T_{stg}$	-65	+150	°C
Temperature under bias	$T_{bias}$	-65	+135	°C

Stresses greater than those listed under *Absolute Maximum Ratings* may cause permanent damage to the device. This is a stress rating only and functional operation of the device at these or any other conditions outside those indicated in the operational sections of this specification is not implied. Exposure to absolute maximum rating conditions may affect reliability.



Synchronous truth table

CE0	CE1	CE2	ADSP	ADSC	ADV	n <sup>†</sup>	OE	Address accessed	CLK	Operation
H	X	X	X	L	X	X	X	NA	L to H	Deselect
L	L	X	L	X	X	X	X	NA	L to H	Deselect
L	L	X	H	L	X	X	X	NA	L to H	Deselect
L	X	H	L	X	X	X	X	NA	L to H	Deselect
L	X	H	H	L	X	X	X	NA	L to H	Deselect
L	H	L	L	X	X	F	L	External	L to H	Begin read
L	H	L	L	X	X	F	H	External	L to H	Begin read
L	H	L	H	L	X	F	L	External	L to H	Begin read
L	H	L	H	L	X	F	H	External	L to H	Begin read
X	X	X	H	H	L	F	L	Next	L to H	Cont. read
X	X	X	H	H	L	F	H	Next	L to H	Cont. read
X	X	X	H	H	H	F	L	Current	L to H	Suspend read
X	X	X	H	H	H	F	H	Current	L to H	Suspend read
H	X	X	X	H	L	F	L	Next	L to H	Cont. read
H	X	X	X	H	L	F	H	Next	L to H	Cont. read
H	X	X	X	H	H	F	L	Current	L to H	Suspend read
H	X	X	X	H	H	F	H	Current	L to H	Suspend read
L	H	L	H	L	X	T	X	External	L to H	Begin write
X	X	X	H	H	L	T	X	Next	L to H	Cont. write
H	X	X	X	H	L	T	X	Next	L to H	Cont. write
X	X	X	H	H	H	T	H	Current	L to H	Suspend write
H	X	X	X	H	H	T	H	Current	L to H	Suspend write

Key: X = Don't Care, L = Low, H = High.

<sup>†</sup>See Write enable truth table for more information.

Recommended operating conditions

Parameter	Symbol	Min	Nominal	Max	Unit	
Supply voltage	V <sub>DD</sub>	3.135	3.3	3.6	V	
	GND	0.0	0.0	0.0	V	
I/O supply voltage	V <sub>DDQ</sub>	2.35	2.5 or 3.3	3.6	V	
	GND <sub>Q</sub>	0.0	0.0	0.0	V	
Input voltages	Address and control pins	V <sub>IH</sub>	2.0	-	4.5	V
		V <sub>IL</sub>	-0.5*	-	0.8	V
	I/O pins	V <sub>IH</sub>	2.0	-	V <sub>DDQ</sub> + 0.5	V
		V <sub>IL</sub>	-0.5*	-	0.8	V
Ambient operating temperature	T <sub>A</sub>	0	-	70	°C	

\* V<sub>IL</sub> min = -2.0V for pulse width less than 0.2 x t<sub>RC</sub>.

DC electrical characteristics over operating range

Parameter	Symbol	Test conditions	-166		-150		-133		-100		Unit
			Min	Max	Min	Max	Min	Max	Min	Max	
Input leakage current	I <sub>LI</sub>	V <sub>DD</sub> = Max, V <sub>in</sub> = GND to V <sub>DD</sub>	-	2	-	2	-	2	-	2	µA
Output leakage current	I <sub>LO</sub>	OE ≥ V <sub>IH</sub> , V <sub>DD</sub> = Max, V <sub>out</sub> = GND to V <sub>DD</sub>	-	2	-	2	-	2	-	2	µA



Parameter	Symbol	Test conditions	-166		-150		-133		-100		Unit
			Min	Max	Min	Max	Min	Max	Min	Max	
Operating power supply current	$I_{CC}$	$\overline{CE} = V_{IL}, CE = V_{IH}, \overline{CE} = V_{IL}, f = f_{max}, I_{out} = 0 \text{ mA}$	-	350	-	325	-	300	-	250	mA
Standby power supply current	$I_{SB}$	$f = f_{max}$	-	60	-	60	-	60	-	60	mA
	$I_{SB1}$	$f = 0$ $I_{IN} \leq 0.2V \text{ or } \geq V_{DD} - 0.2V$	-	5	-	5	-	5	-	5	mA
Output voltage	$V_{OL}$	$I_{OL} = 8 \text{ mA}, V_{DDQ} = 3.6V$	-	0.4	-	0.4	-	0.4	-	0.4	V
	$V_{OH}$	$I_{OH} = -8 \text{ mA}, V_{DDQ} = 3.0V$	2.4	-	2.4	-	2.4	-	2.4	-	V

### Timing characteristics over operating range

Parameter	Symbol	-3.5		-3.8		-4		-5		Unit	Notes
		Min	Max	Min	Max	Min	Max	Min	Max		
Clock frequency	$F_{MAX}$	-	166	-	150	-	133	-	100	MHz	1
Cycle time (pipelined mode)	$t_{CYC}$	6	-	6.6	-	7.5	-	10	-	ns	
Clock access time (pipelined mode)	$t_{CD}$	-	3.5	-	3.8	-	4	-	5	ns	
Clock access time (flow-through mode)	$t_{CDF}$	-	6	-	6.6	-	7.5	-	10	ns	
Output enable Low to data valid	$t_{OE}$	-	3.5	-	3.5	-	3.8	-	4	ns	
Clock High to output Low Z	$t_{LZC}$	0	-	0	-	0	-	0	-	ns	8
Data output hold from clock High	$t_{OH}$	1.5	-	1.5	-	1.5	-	2	-	ns	8
Output enable Low to output Low Z	$t_{LZOE}$	1	-	1	-	1.5	-	2	-	ns	8
Output enable High to output High Z	$t_{HZOE}$	-	3	-	3.5	-	4	-	4	ns	8
Clock High to output High Z	$t_{HZC}$	-	2.5	-	3	-	3.5	-	3.5	ns	8
Clock High to output High Z	$t_{HZCN}$	-	1.5	-	1.5	-	2	-	2.5	ns	1,9
Clock High pulse width	$t_{CH}$	2.4	-	2.6	-	2.8	-	3	-	ns	
Clock Low pulse width	$t_{CL}$	2.4	-	2.6	-	2.8	-	3	-	ns	
Address and Control setup to clock High	$t_{AS}$	1	-	1.3	-	1.5	-	1.5	-	ns	
Data setup to clock High	$t_{DS}$	1	-	1.3	-	1.5	-	1.5	-	ns	
Write setup to clock High	$t_{WS}$	1	-	1.3	-	1.5	-	1.5	-	ns	
Chip select setup to clock High	$t_{CSS}$	1	-	1.3	-	1.5	-	1.5	-	ns	
Address hold from clock High	$t_{AH}$	0.5	-	0.5	-	0.5	-	0.5	-	ns	
Data hold from clock High	$t_{DH}$	0.5	-	0.5	-	0.5	-	0.5	-	ns	
Write hold from clock High	$t_{WH}$	0.5	-	0.5	-	0.5	-	0.5	-	ns	
Chip select hold from clock High	$t_{CSH}$	0.5	-	0.5	-	0.5	-	0.5	-	ns	
Output rise time (0 pF load)	$t_R$	1.5	-	1.5	-	1.5	-	1.5	-	V/ns	1
Output fall time (0 pF load)	$t_F$	1.5	-	1.5	-	1.5	-	1.5	-	V/ns	1

See "Notes" on page 9.

### Key to switching waveforms

Rising input

Falling input

Undefined/don't care



Timing waveform of read cycle

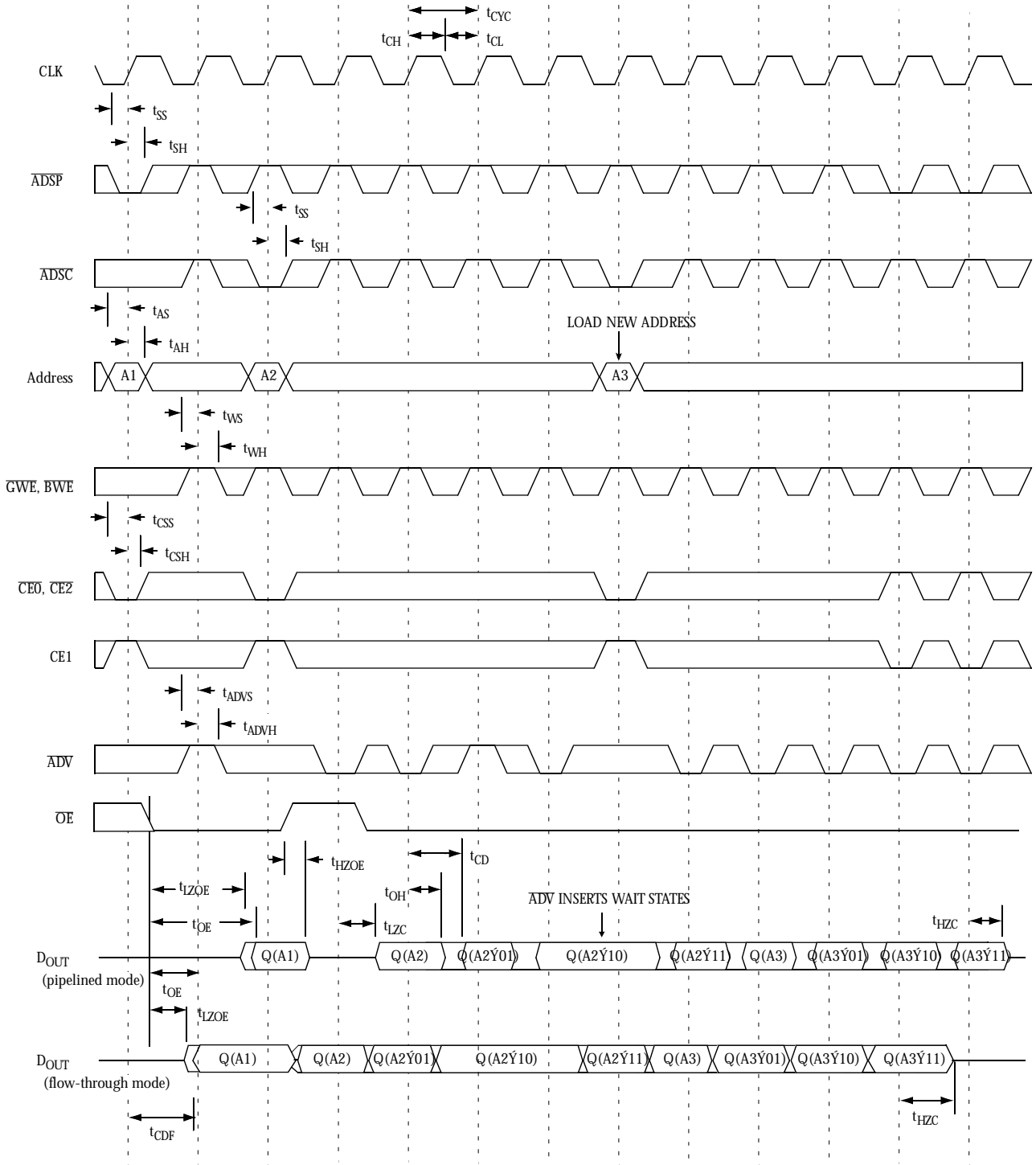

Note:  $\oplus$  = XOR when MODE = High/No Connect;  $\oplus$  = ADD when MODE = Low. Refer to Burst Sequence Table.  
 [0:3] is don't care.



Timing waveform of write cycle

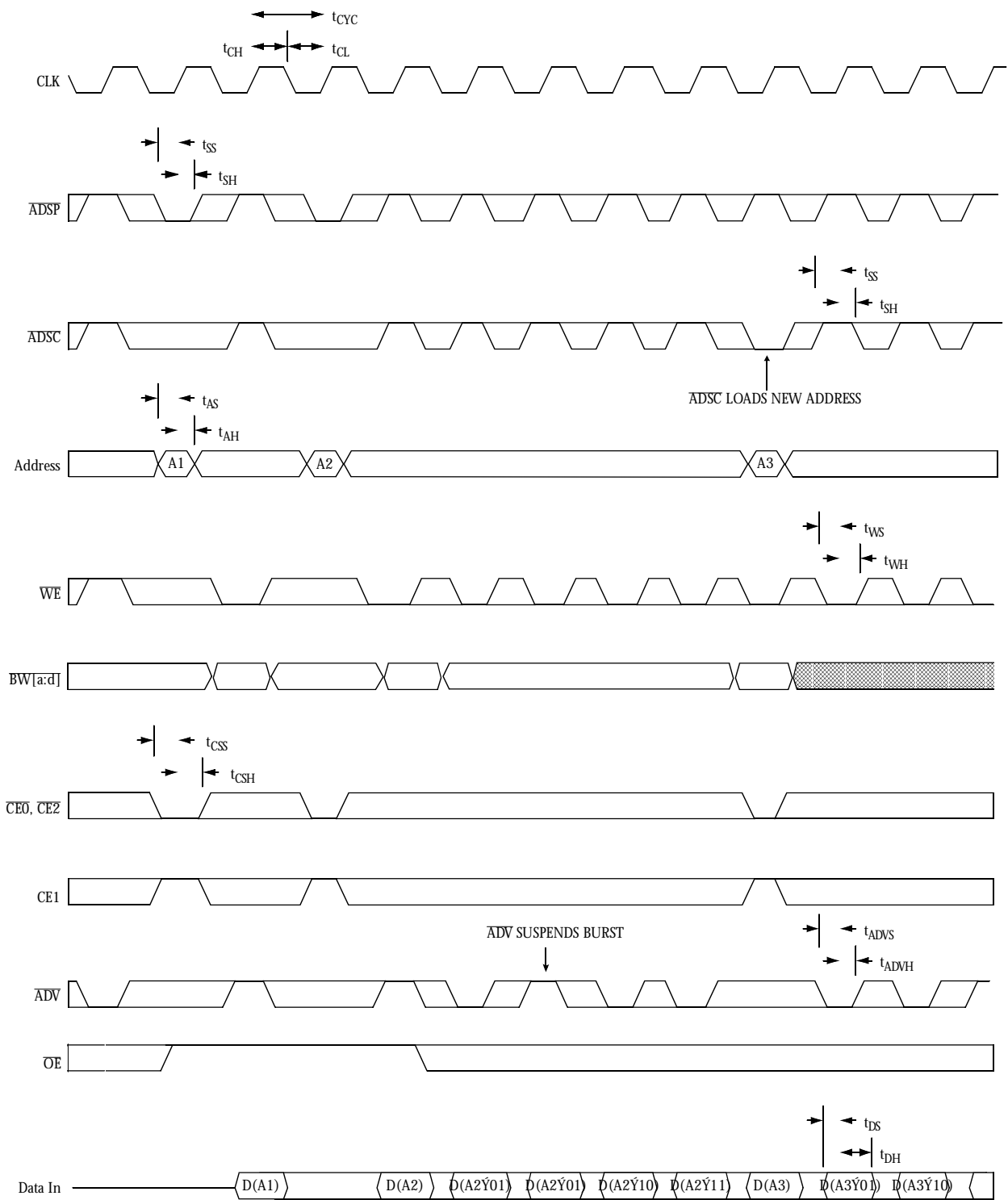

Note:  $\oplus$  = XOR when MODE = High/No Connect;  $\oplus$  = ADD when MODE = Low. Refer to Burst Sequence Table.



Timing waveform of read/write cycle

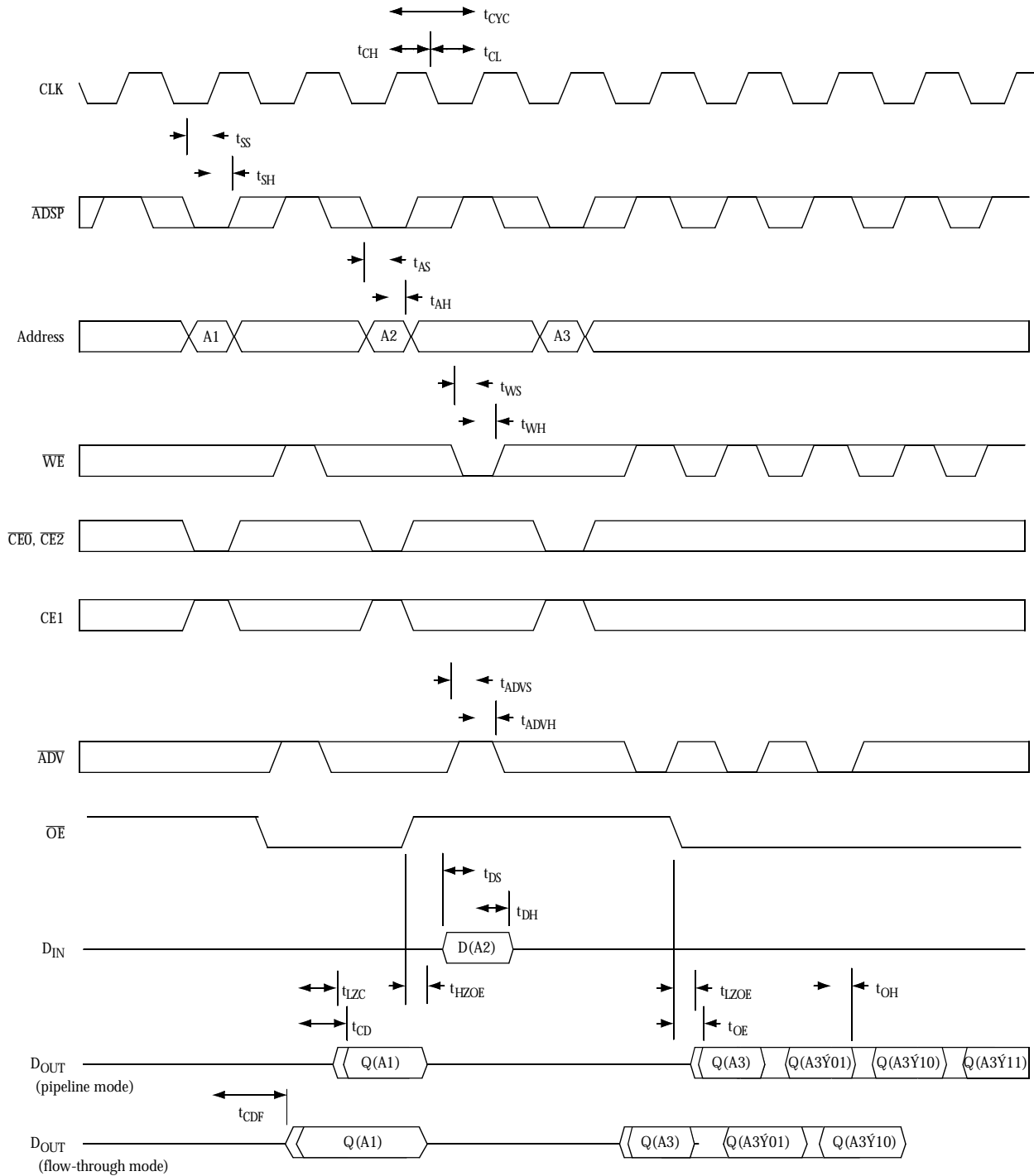

Note: ⊕ = XOR when MODE = High/No Connect; ⊕ = ADD when MODE = Low. Refer to Burst Sequence Table.





Notes

- 1 This parameter is guaranteed but not tested.
- 2 For test conditions, see AC Test Conditions, Figures A, B, C.
- 3 This parameter is sampled and not 100% tested.
- 4 This is a synchronous device. All addresses must meet the specified setup and hold times for all rising edges of CLK. All other synchronous inputs must meet the setup and hold times with stable logic levels for all rising edges of CLK when chip is enabled.
- 5 Typical values measured at 3.3V, 25°C and 10 ns cycle time.
- 6  $I_{CC}$  given with no output loading.  $I_{CC}$  increases with faster cycle times and greater output loading
- 7 Transitions are measured  $\pm 500$  mV from steady state voltage. Output loading specified with  $C_L = 5$  pF as in Figure C.
- 8  $t_{HZOE}$  is less than  $t_{LZOE}$ ; and  $t_{HZC}$  is less than  $t_{LZC}$  at any given temperature and voltage.
- 9  $t_{HZCN}$  is a 'no load' parameter to indicate exactly when SRAM outputs have stopped driving.

AC test conditions

- Output Load: see Figure B, except for  $t_{LZC}$ ,  $t_{LZOE}$ ,  $t_{HZOE}$ ,  $t_{HZC}$  see Figure C.
- Input pulse level: GND to 3V. See Figure A.
- Input rise and fall time (Measured at 0.3V and 2.7V): 2 ns. See Figure A.
- Input and output timing reference levels: 1.5V.

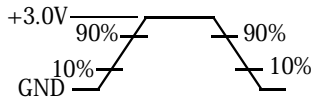

Figure A: Input waveform

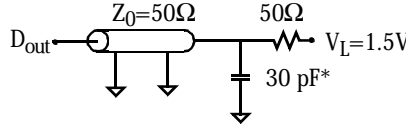

Figure B: Output load (A)

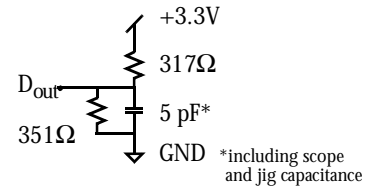

Figure C: Output load (B)

AS7C3128PFS32/36A ordering information

Package	Functionality	166 MHz	150 MHz	133 MHz	100 MHz
TQFP	PBSRAM	AS7C3128PFS32/36AP-3.5TQC	AS7C3128PFS32/36A-3.8TQC	AS7C3128PFS32/36A-4TQC	AS7C3128PFS32/36A-5TQC
TQFP	PBSRAM	AS7C3128PFS32/36A-3.5TQC	AS7C3128PFS32/36A-3.8TQC	AS7C3128PFS32/36A-4TQC	AS7C3128PFS32/36A-5TQC

AS7C3128K32P and AS7C3128PFS32/36A part numbering system

AS7C	3	128K36	P	-XX	XX	C
SRAM prefix	Operating voltage	Part number, organization	Timing NTD=NTD timing P=PBSRAM	NTD=NTD timing access time (ns)	Package: TQ = TQFP	Commercial temperature, 0°C to 70 °C

NTD is a trademark of Integrated Device Technology, Inc.  
Pentium is a trademark of Intel Corporation.