

## 16K x 4 Bit Static RAM With Output Enable

The MCM6290C (with output enable) is a 65,536 bit static random access memory organized as 16,384 words of 4 bits, fabricated using Motorola's high-performance silicon-gate CMOS technology. Static design eliminates the need for external clocks or timing strobes, while CMOS circuitry reduces power consumption for greater reliability.

The chip enable ( $\bar{E}$ ) pin is not a clock. In less than a cycle time after  $\bar{E}$  goes high, the part enters a low-power standby mode, remaining in that state until  $\bar{E}$  goes low again. This feature reduces system power requirements without degrading access time performance.

The MCM6290C has both chip enable ( $\bar{E}$ ) and output enable ( $\bar{G}$ ) inputs, allowing greater system flexibility. Either input, when high, will force the outputs to high impedance.

- Single 5 V  $\pm$  10% Power Supply
- Low Power Operation: 120 mA Maximum, Active AC
- Fully Static — No Clock or Timing Strokes Necessary
- Fast Access Times: 10, 12, 15, 20, 25, 35 ns
- Two Chip Controls:
  - $\bar{E}$  for Automatic Power Down
  - $\bar{G}$  for Fast Access to Data and Elimination of Bus Contention Problems
- Fully TTL Compatible — Three-State Data Output

**BLOCK DIAGRAM**

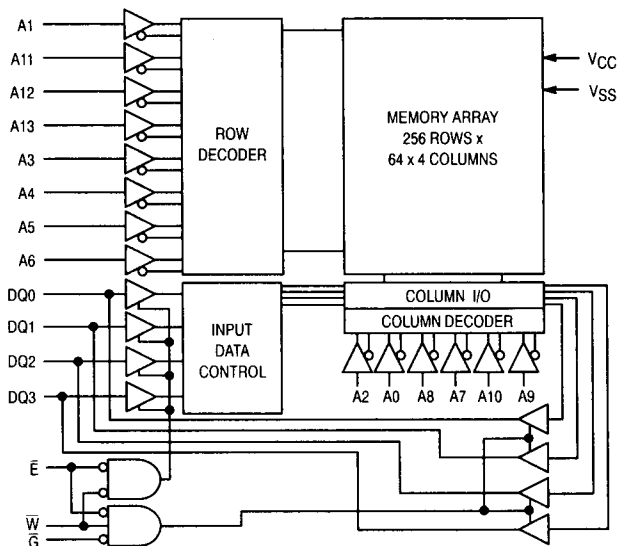

## MCM6290C

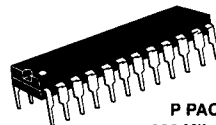

**P PACKAGE**  
 300 MIL PLASTIC  
 CASE 724A



**J PACKAGE**  
 300 MIL SOJ  
 CASE 810A

**3**

### PIN ASSIGNMENT

|           |    |   |    |           |
|-----------|----|---|----|-----------|
| A0        | 1  | • | 24 | VCC       |
| A1        | 2  |   | 23 | A13       |
| A2        | 3  |   | 22 | A12       |
| A3        | 4  |   | 21 | A11       |
| A4        | 5  |   | 20 | A10       |
| A5        | 6  |   | 19 | A9        |
| A6        | 7  |   | 18 | NC        |
| A7        | 8  |   | 17 | DQ0       |
| A8        | 9  |   | 16 | DQ1       |
| $\bar{E}$ | 10 |   | 15 | DQ2       |
| $\bar{G}$ | 11 |   | 14 | DQ3       |
| VSS       | 12 |   | 13 | $\bar{W}$ |

### PIN NAMES

|           |                        |
|-----------|------------------------|
| A0 - A13  | Address Input          |
| DQ0 - DQ3 | Data Input/Data Output |
| $\bar{W}$ | Write Enable           |
| $\bar{G}$ | Output Enable          |
| $\bar{E}$ | Chip Enable            |
| NC        | No Connection          |
| VCC       | Power Supply (+ 5 V)   |
| VSS       | Ground                 |

**TRUTH TABLE** (X = Don't Care)

| $\bar{E}$ | $\bar{G}$ | $\bar{W}$ | Mode            | V <sub>CC</sub> Current             | I/O Pin          |
|-----------|-----------|-----------|-----------------|-------------------------------------|------------------|
| H         | X         | X         | Not Selected    | I <sub>SB1</sub> , I <sub>SB2</sub> | High-Z           |
| L         | H         | H         | Output Disabled | I <sub>CCA</sub>                    | High-Z           |
| L         | L         | H         | Read            | I <sub>CCA</sub>                    | D <sub>out</sub> |
| L         | X         | L         | Write           | I <sub>CCA</sub>                    | D <sub>in</sub>  |

**ABSOLUTE MAXIMUM RATINGS** (See Note)

| Rating   | Symbol                             | Value                          | Unit |
|--|------------------------------------|--------------------------------|------|
| Power Supply Voltage   | V <sub>CC</sub>                    | - 0.5 to + 7.0                 | V    |
| Voltage Relative to V <sub>SS</sub> For Any Pin Except V <sub>CC</sub> | V <sub>in</sub> , V <sub>out</sub> | - 0.5 to V <sub>CC</sub> + 0.5 | V    |
| Output Current   | I <sub>out</sub>                   | ± 20                           | mA   |
| Power Dissipation  | P <sub>D</sub>                     | 1.0                            | W    |
| Temperature Under Bias (T <sub>A</sub> = 25°C)                         | T <sub>bias</sub>                  | - 10 to + 85                   | °C   |
| Operating Temperature  | T <sub>A</sub>                     | 0 to + 70                      | °C   |
| Storage Temperature — Plastic  | T <sub>stg</sub>                   | - 55 to + 125                  | °C   |

NOTE: Permanent device damage may occur if ABSOLUTE MAXIMUM RATINGS are exceeded. Functional operation should be restricted to RECOMMENDED OPERATING CONDITIONS. Exposure to higher than recommended voltages for extended periods of time could affect device reliability.

This device contains circuitry to protect the inputs against damage due to high static voltages or electric fields; however, it is advised that normal precautions be taken to avoid application of any voltage higher than maximum rated voltages to this high-impedance circuit.

This CMOS memory circuit has been designed to meet the dc and ac specifications shown in the tables, after thermal equilibrium has been established. The circuit is in a test socket or mounted on a printed circuit board and transverse air flow of at least 500 linear feet per minute is maintained.

**DC OPERATING CONDITIONS AND CHARACTERISTICS**

(V<sub>CC</sub> = 5.0 V ± 10%, T<sub>A</sub> = 0 to 70°C, Unless Otherwise Noted)

**RECOMMENDED OPERATING CONDITIONS**

| Parameter                                | Symbol          | Min    | Typ | Max                     | Unit |
|--|-----------------|--------|-----|-------------------------|------|
| Supply Voltage (Operating Voltage Range) | V <sub>CC</sub> | 4.5    | 5.0 | 5.5                     | V    |
| Input High Voltage                       | V <sub>IH</sub> | 2.2    | —   | V <sub>CC</sub> + 0.3** | V    |
| Input Low Voltage                        | V <sub>IL</sub> | - 0.5* | —   | 0.8                     | V    |

\* V<sub>IL</sub> (min) = - 0.5 V dc; V<sub>IL</sub> (min) = - 2.0 V ac (pulse width ≤ 20 ns)

\*\* V<sub>IH</sub> (max) = V<sub>CC</sub> + 0.3 V dc; V<sub>IH</sub> (max) = V<sub>CC</sub> + 2.0 V ac (pulse width ≤ 20 ns)

**DC CHARACTERISTICS**

| Parameter   | Symbol             | Min | Max | Unit |
|---|--------------------|-----|-----|------|
| Input Leakage Current (All Inputs, V <sub>in</sub> = 0 to V <sub>CC</sub> )   | I <sub>kg(I)</sub> | —   | ± 1 | μA   |
| Output Leakage Current ( $\bar{E} = V_{IH}$ or $\bar{G} = V_{IH}$ , V <sub>out</sub> = 0 to V <sub>CC</sub> )   | I <sub>kg(O)</sub> | —   | ± 1 | μA   |
| Standby Current ( $\bar{E} \geq V_{CC} - 0.2$ V, V <sub>in</sub> ≤ V <sub>SS</sub> + 0.2 V, or ≥ V <sub>CC</sub> - 0.2 V, V <sub>CC</sub> = Max, f = 0 MHz) | I <sub>SB2</sub>   | —   | 10  | mA   |
| Output Low Voltage (I <sub>OL</sub> = 8.0 mA)   | V <sub>OL</sub>    | —   | 0.4 | V    |
| Output High Voltage (I <sub>OH</sub> = - 4.0 mA)  | V <sub>OH</sub>    | 2.4 | —   | V    |

**POWER SUPPLY CURRENTS**

| Parameter   | Symbol           | - 10 | - 12 | - 15 | - 20 | - 25 | - 35 | Unit |
|---|------------------|------|------|------|------|------|------|------|
| AC Supply Current (I <sub>out</sub> = 0 mA)         | I <sub>CCA</sub> | 120  | 120  | 120  | 110  | 110  | 110  | mA   |
| Standby Current (TTL Levels, V <sub>CC</sub> = Max) | I <sub>SB1</sub> | 50   | 45   | 40   | 35   | 30   | 30   | mA   |

**CAPACITANCE** (f = 1 MHz, dV = 3 V, T<sub>A</sub> = 25°C, Periodically Sampled Rather Than 100% Tested)

| Characteristic                        | Symbol           | Max | Unit |
|---------------------------------------|------------------|-----|------|
| Address and Control Input Capacitance | C <sub>in</sub>  | 6   | pF   |
| I/O Capacitance                       | C <sub>I/O</sub> | 7   | pF   |

## AC OPERATING CONDITIONS AND CHARACTERISTICS

( $V_{CC} = 5.0\text{ V} \pm 10\%$ ,  $T_A = 0$  to  $+70^\circ\text{C}$ , Unless Otherwise Noted)

Input Timing Measurement Reference Level ..... 1.5 V      Output Timing Measurement Reference Level ..... 1.5 V  
 Input Pulse Levels ..... 0 to 3.0 V      Output Load ..... Figure 1A Unless Otherwise Noted  
 Input Rise/Fall Time ..... 5 ns

### READ CYCLE (See Notes 1 and 2)

| Parameters                          | Symbol              |                  | - 10 |     | - 12 |     | - 15 |     | - 20 |     | - 25 |     | - 35 |     | Unit | Notes |
|-------------------------------------|---------------------|------------------|------|-----|------|-----|------|-----|------|-----|------|-----|------|-----|------|-------|
|                                     | Std                 | Alt              | Min  | Max | Min  | Max | Min  | Max | Min  | Max | Min  | Max | Min  | Max |      |       |
| Read Cycle Time                     | t <sub>AVAV</sub>   | t <sub>RC</sub>  | 10   | —   | 12   | —   | 15   | —   | 20   | —   | 25   | —   | 35   | —   | ns   | 3     |
| Address Access Time                 | t <sub>AVQV</sub>   | t <sub>AA</sub>  | —    | 10  | —    | 12  | —    | 15  | —    | 20  | —    | 25  | —    | 35  | ns   |       |
| Enable Access Time                  | t <sub>ELQV</sub>   | t <sub>ACS</sub> | —    | 10  | —    | 12  | —    | 15  | —    | 20  | —    | 25  | —    | 35  | ns   | 4     |
| Output Enable Access Time           | t <sub>GLQV</sub>   | t <sub>OE</sub>  | —    | 5   | —    | 6   | —    | 8   | —    | 10  | —    | 12  | —    | 15  | ns   |       |
| Output Hold from Address Change     | t <sub>AXQX</sub>   | t <sub>OH</sub>  | 4    | —   | 4    | —   | 4    | —   | 4    | —   | 4    | —   | 4    | —   | ns   | 5,6,7 |
| Enable Low to Output Active         | t <sub>ELQX</sub>   | t <sub>CLZ</sub> | 4    | —   | 4    | —   | 4    | —   | 4    | —   | 4    | —   | 4    | —   | ns   | 5,6,7 |
| Enable High to Output High-Z        | t <sub>EHQZ</sub>   | t <sub>CHZ</sub> | 0    | 5   | 0    | 6   | 0    | 8   | 0    | 8   | 0    | 10  | 0    | 15  | ns   | 5,6,7 |
| Output Enable Low to Output Active  | t <sub>GLQX</sub>   | t <sub>OLZ</sub> | 0    | —   | 0    | —   | 0    | —   | 0    | —   | 0    | —   | 0    | —   | ns   | 5,6,7 |
| Output Enable High to Output High-Z | t <sub>GHQZ</sub>   | t <sub>OHZ</sub> | 0    | 5   | 0    | 6   | 0    | 7   | 0    | 8   | 0    | 10  | 0    | 15  | ns   | 5,6,7 |
| Power Up Time                       | t <sub>ELICCH</sub> | t <sub>PU</sub>  | 0    | —   | 0    | —   | 0    | —   | 0    | —   | 0    | —   | 0    | —   | ns   |       |
| Power Down Time                     | t <sub>EHICCL</sub> | t <sub>PD</sub>  | —    | 10  | —    | 12  | —    | 15  | —    | 20  | —    | 25  | —    | 35  | ns   |       |

#### NOTES:

1.  $\bar{W}$  is high for read cycle.
2. For devices with multiple chip enables,  $\bar{E}1$  and  $E2$  are represented by  $\bar{E}$  in this data sheet.  $E2$  is of opposite polarity to  $\bar{E}$ .
3. All timings are referenced from the last valid address to the first transitioning address.
4. Addresses valid prior to or coincident with  $\bar{E}$  going low.
5. At any given voltage and temperature, t<sub>EHQZ</sub> max is less than t<sub>ELQX</sub> min, and t<sub>GHQZ</sub> max is less than t<sub>GLQX</sub> min, both for a given device and from device to device.
6. Transition is measured  $\pm 500$  mV from steady-state voltage with load of Figure 1B.
7. This parameter is sampled and not 100% tested.
8. Device is continuously selected ( $\bar{E}1 = V_{IL}$ ,  $E2 = V_{IH}$ ,  $\bar{G} = V_{IL}$ ).

### AC TEST LOADS

### TIMING LIMITS

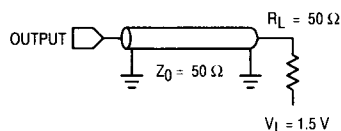

Figure 1A

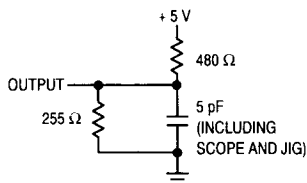
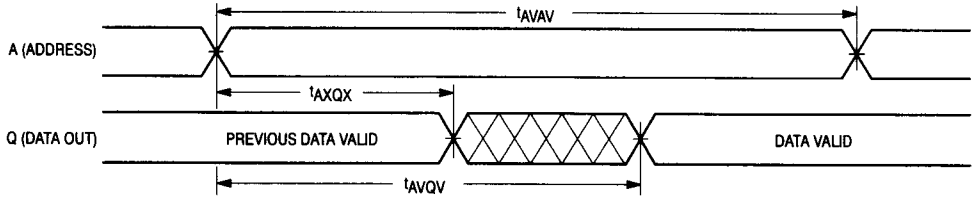

Figure 1B

The table of timing values shows either a minimum or a maximum limit for each parameter. Input requirements are specified from the external system point of view. Thus, address setup time is shown as a minimum since the system must supply at least that much time (even though most devices do not require it). On the other hand, responses from the memory are specified from the device point of view. Thus, the access time is shown as a maximum since the device never provides data later than that time.

For information on output I-V characteristics, see Chapter 8, Section 1.

**READ CYCLE 1** (See Note 8)



**READ CYCLE 2** (See Notes 2 and 4)

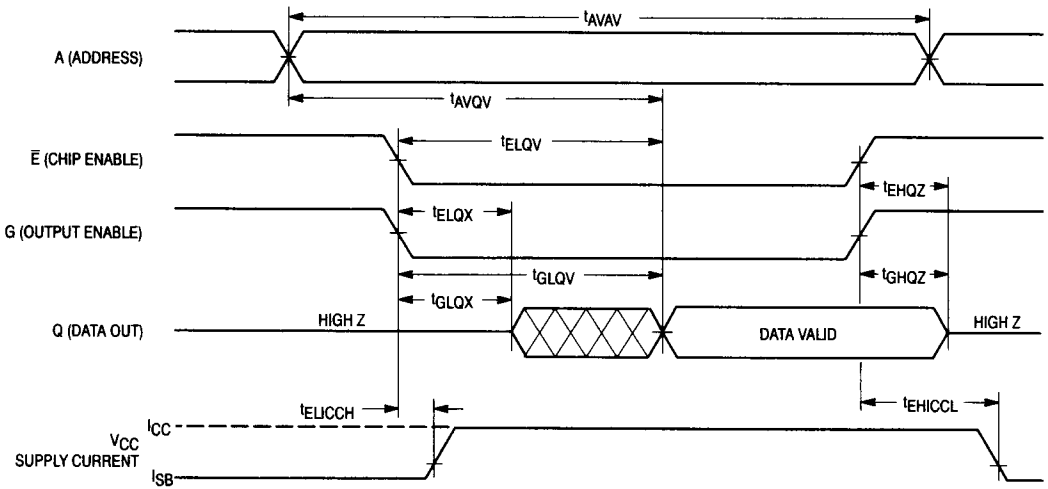

**WRITE CYCLE 1** ( $\bar{W}$  Controlled, See Notes 1, 2, and 3)

| Parameter                            | Symbol                     |          | - 10 |     | - 12 |     | - 15 |     | - 20 |     | - 25 |     | - 35 |     | Unit | Notes |
|--------------------------------------|----------------------------|----------|------|-----|------|-----|------|-----|------|-----|------|-----|------|-----|------|-------|
|                                      | Std                        | Alt      | Min  | Max | Min  | Max | Min  | Max | Min  | Max | Min  | Max | Min  | Max |      |       |
| Write Cycle Time                     | $t_{AVAV}$                 | $t_{WC}$ | 10   | —   | 12   | —   | 15   | —   | 20   | —   | 25   | —   | 35   | —   | ns   | 4     |
| Address Setup Time                   | $t_{AVWL}$                 | $t_{AS}$ | 0    | —   | 0    | —   | 0    | —   | 0    | —   | 0    | —   | 0    | —   | ns   |       |
| Address Valid to End of Write        | $t_{AVWH}$                 | $t_{AW}$ | 9    | —   | 10   | —   | 12   | —   | 15   | —   | 20   | —   | 30   | —   | ns   |       |
| Write Pulse Width                    | $t_{WLWH}$ ,<br>$t_{WLEH}$ | $t_{WP}$ | 9    | —   | 10   | —   | 12   | —   | 15   | —   | 20   | —   | 30   | —   | ns   |       |
| Write Pulse Width,<br>$\bar{G}$ High | $t_{WLWH}$ ,<br>$t_{WLEH}$ | $t_{WP}$ | 7    | —   | 8    | —   | 10   | —   | 12   | —   | 15   | —   | 25   | —   | ns   | 5     |
| Data Valid to End of Write           | $t_{DVWH}$                 | $t_{DW}$ | 5    | —   | 6    | —   | 7    | —   | 8    | —   | 10   | —   | 15   | —   | ns   |       |
| Data Hold Time                       | $t_{WHDX}$                 | $t_{DH}$ | 0    | —   | 0    | —   | 0    | —   | 0    | —   | 0    | —   | 0    | —   | ns   |       |
| Write Low to Output High-Z           | $t_{WLQZ}$                 | $t_{WZ}$ | 0    | 5   | 0    | 6   | 0    | 7   | 0    | 8   | 0    | 10  | 0    | 15  | ns   | 6,7,8 |
| Write High to Output Active          | $t_{WHQX}$                 | $t_{OW}$ | 4    | —   | 4    | —   | 4    | —   | 4    | —   | 4    | —   | 4    | —   | ns   | 6,7,8 |
| Write Recovery Time                  | $t_{WHAX}$                 | $t_{WR}$ | 0    | —   | 0    | —   | 0    | —   | 0    | —   | 0    | —   | 0    | —   | ns   |       |

**NOTES:**

1. A write occurs during the overlap of  $\bar{E}$  low and  $\bar{W}$  low.
2. For devices with multiple chip enables,  $\bar{E}1$  and  $\bar{E}2$  are represented by  $\bar{E}$  in this data sheet.  $\bar{E}2$  is of opposite polarity to  $\bar{E}$ .
3. For Output Enable devices, if  $\bar{G}$  goes low coincident with or after  $\bar{W}$  goes low, the output will remain in a high impedance state.
4. All timings are referenced from the last valid address to the first transitioning address.
5. For Output Enable devices, if  $\bar{G} \geq V_{IH}$ , the output will remain in a high impedance state.
6. At any given voltage and temperature,  $t_{WLQZ}$  max is less than  $t_{WHQX}$  min, both for a given device and from device to device.
7. Transition is measured  $\pm 500$  mV from steady-state voltage with load of Figure 1B.
8. This parameter is sampled and not 100% tested.

**WRITE CYCLE 1** ( $\bar{W}$  Controlled, See Notes 1 and 2)

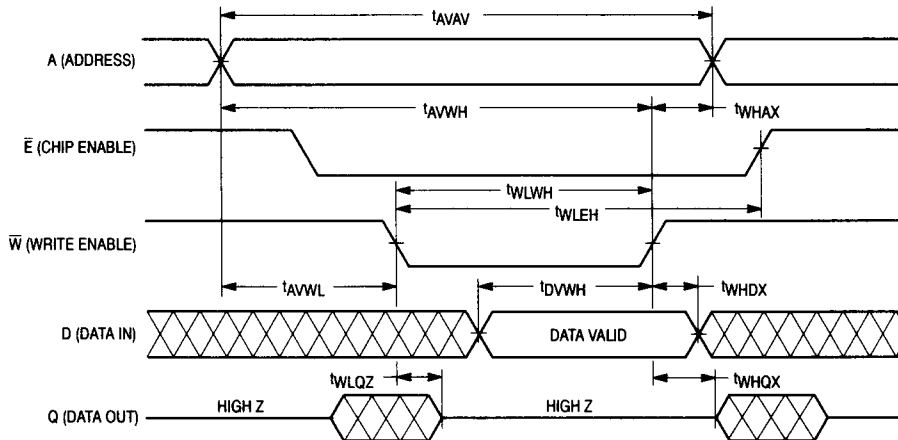

**WRITE CYCLE 2** ( $\bar{E}$  Controlled, See Notes 1, 2, and 3)

| Parameter                     | Symbol                                   |                 | - 10 |     | - 12 |     | - 15 |     | - 20 |     | - 25 |     | - 35 |     | Unit | Notes |
|-------------------------------|--|-----------------|------|-----|------|-----|------|-----|------|-----|------|-----|------|-----|------|-------|
|                               | Std                                      | Alt             | Min  | Max | Min  | Max | Min  | Max | Min  | Max | Min  | Max | Min  | Max |      |       |
| Write Cycle Time              | t <sub>AVAV</sub>                        | t <sub>WC</sub> | 10   | —   | 12   | —   | 15   | —   | 20   | —   | 25   | —   | 35   | —   | ns   | 4     |
| Address Setup Time            | t <sub>AVEL</sub>                        | t <sub>AS</sub> | 0    | —   | 0    | —   | 0    | —   | 0    | —   | 0    | —   | 0    | —   | ns   |       |
| Address Valid to End of Write | t <sub>AVEH</sub>                        | t <sub>AW</sub> | 8    | —   | 8    | —   | 12   | —   | 15   | —   | 20   | —   | 25   | —   | ns   |       |
| Enable to End of Write        | t <sub>ELEH</sub> ,<br>t <sub>ELWH</sub> | t <sub>CW</sub> | 7    | —   | 8    | —   | 10   | —   | 12   | —   | 15   | —   | 25   | —   | ns   | 5, 6  |
| Data Valid to End of Write    | t <sub>DVEH</sub>                        | t <sub>DW</sub> | 5    | —   | 6    | —   | 7    | —   | 8    | —   | 10   | —   | 15   | —   | ns   |       |
| Data Hold Time                | t <sub>EHDX</sub>                        | t <sub>DH</sub> | 0    | —   | 0    | —   | 0    | —   | 0    | —   | 0    | —   | 0    | —   | ns   |       |
| Write Recovery Time           | t <sub>EHAX</sub>                        | t <sub>WR</sub> | 0    | —   | 0    | —   | 0    | —   | 0    | —   | 0    | —   | 0    | —   | ns   |       |

**NOTES:**

1. A write occurs during the overlap of  $\bar{E}$  low and  $\bar{W}$  low.
2. For devices with multiple chip enables, E1 and E2 are represented by  $\bar{E}$  in this data sheet. E2 is of opposite polarity to  $\bar{E}$ .
3. For Output Enable devices, if  $\bar{G}$  goes low coincident with or after  $\bar{W}$  goes low, the output will remain in a high impedance state.
4. All timings are referenced from the last valid address to the first transitioning address.
5. If  $\bar{E}$  goes low coincident with or after  $\bar{W}$  goes low, the output will remain in a high impedance state.
6. If  $\bar{E}$  goes high coincident with or before  $\bar{W}$  goes high, the output will remain in a high impedance state.

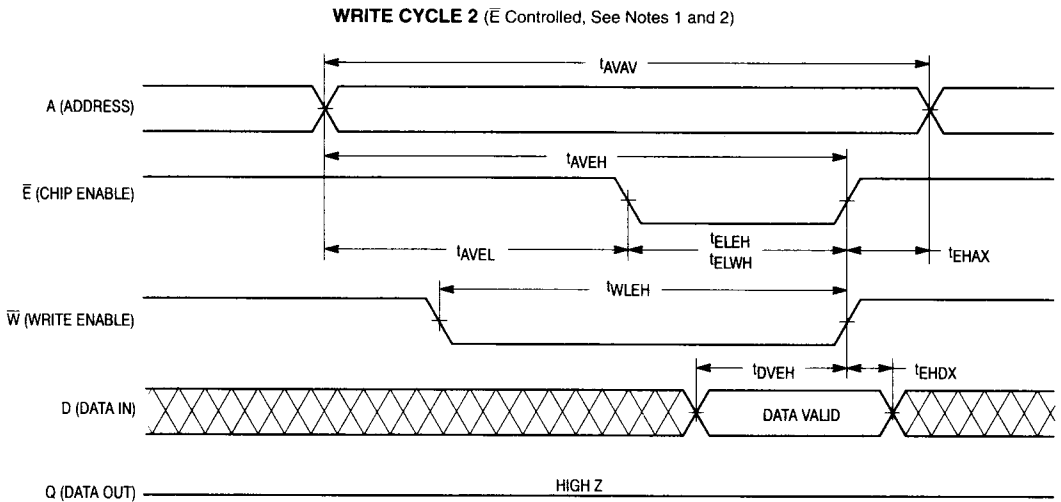

**ORDERING INFORMATION**

(Order by Full Part Number)

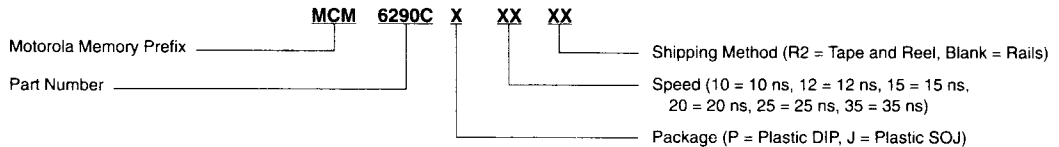

Full Part Numbers —

|             |             |               |
|-------------|-------------|---------------|
| MCM6290CP12 | MCM6290CJ10 | MCM6290CJ10R2 |
| MCM6290CP15 | MCM6290CJ12 | MCM6290CJ12R2 |
| MCM6290CP20 | MCM6290CJ15 | MCM6290CJ15R2 |
| MCM6290CP25 | MCM6290CJ20 | MCM6290CJ20R2 |
| MCM6290CP35 | MCM6290CJ25 | MCM6290CJ25R2 |
|             | MCM6290CJ35 | MCM6290CJ35R2 |