

## Features

- LNA Mixer integration.
- Typical conversion gain of 7 dB.
- Typical Two-Tone IM Ratio of  $\geq 50$  dBm.
- LO Drive-Level: +13 dBm.
- Surface Mount QSOP16 Package.
- Low Cost/High Performance.
- 50 ohm Nominal Impedance.

## Description

M/A-COM's SA65-0003 is an integrated assembly containing a GaAs FET MMIC LNA and GaAs FET mixer. This device is packaged in a 16-leaded QSOP plastic surface mount package. The amplifier can be biased with either +3V or +5V, the mixer requires no DC bias. The conversion gain of the integrated combination is typically 6 dB at +3V bias and 8 dB at +5V bias. The SA65-0003 is ideally suited for RF/IF communications applications requiring down conversion with some gain.

This MCM contains a mixer that is fabricated using a mature 1-micron GaAs process, it also contains an LNA that is fabricated using a low cost mature 0.5-micron gate length GaAs MESFET process. Both die feature full passivation for increased performance and reliability.

## Functional Block Diagram

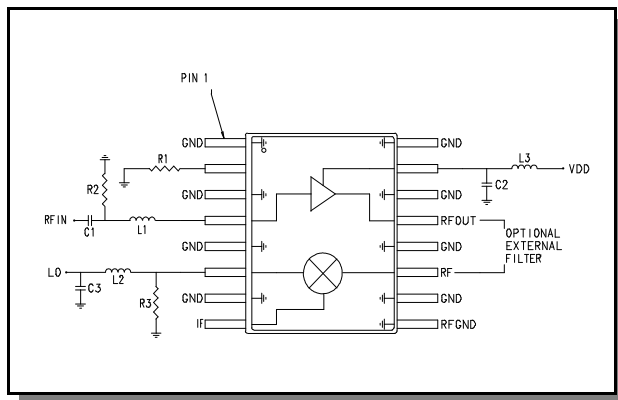

## QSOP-16

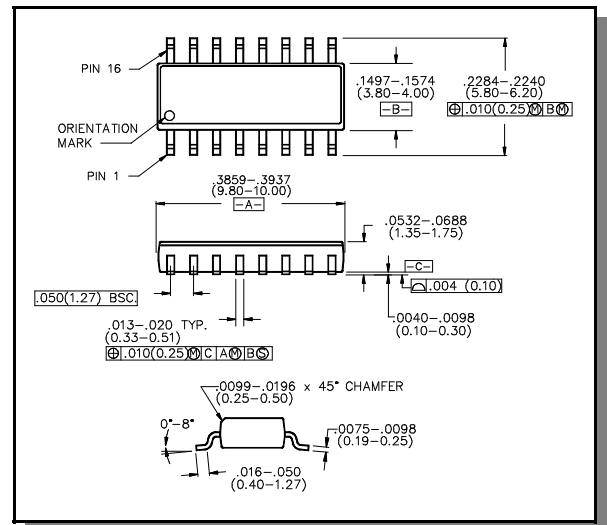

## Recommended PCB Layout

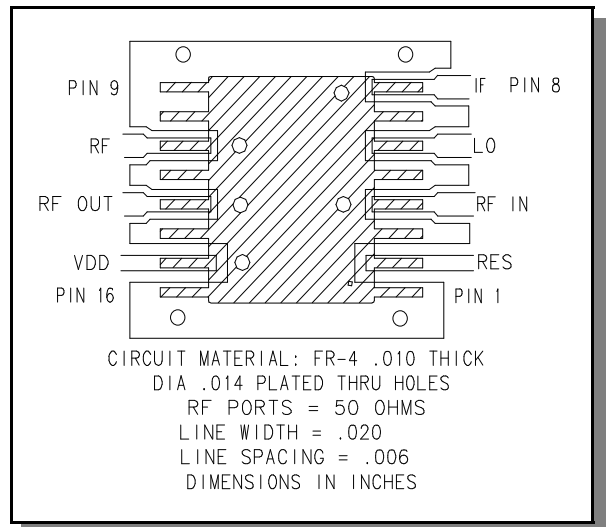

## Electrical Specifications $T_A = +25^\circ\text{C}$ , $Z_0=50\ \Omega$ , $RF = -10\ \text{dBm}^1$ , $LO = +13\ \text{dBm}$ , $I_{DD} \gg 45\ \text{mA}$

Parameter	Test Conditions <sup>1</sup>	Units	Min	Typical	Max
Conversion Gain <sup>6,7</sup>	LNA +3V	dB	3.1	6.0	6.6
	LNA +5V	dB	4.6	8.0	8.8
Isolation <sup>4</sup>	LO to RF IN	dB	29	32	—
	LO to IF	dB	19	23	—
Reverse Isolation <sup>5</sup>	LNA +3V	dB	30	40	—
VSWR	LO	Ratio	—	1.4:1	—
	RF IN	Ratio	—	1.9:1	2.5:1
	IF	Ratio	—	1.9:1	2.1:1
Input IP <sub>3</sub> <sup>1,2,3</sup>	LNA +3V	dB	13	17.5	—
	LNA +5V	dB	21	25	—

- For IP<sub>3</sub> measurements, RFIN = -24 dBm, this low RF IN level gets amplified through the LNA.
- For IP<sub>3</sub> measurements, RFIN2 = RFIN1 + 10 MHz, LO = RFIN1—140 MHz.
- For IP<sub>3</sub> measurements, IP<sub>3</sub> = IMR/2 + PIN.
- RF IN to IF Isolation is typically 0 dB.
- Reverse Isolation is measured from IF to RFIN with the IF at -10 dBm, LO at +13 dBm.
- The amplifier has a normal gain of 12.5 dB, 3V bias and 14.0 dB, 5V bias. Amplifier typical Noise Figure = 1.5 dB.
- $NF_T = NF_1 + (NF_2 - 1)/G_1$

## Absolute Maximum Ratings<sup>8</sup>

Parameter	Absolute Maximum
RF Input Power <sup>9</sup>	+17 dBm
LO Drive Power <sup>9</sup>	+23 dBm
V <sub>DD</sub>	+10 VDC
Current <sup>10</sup>	80 mA
Channel Temperature <sup>11</sup>	+150°C
Operating Temperature	-40°C to +85°C
Storage Temperature	-65°C to +150°C

- Operation of this device above any one of these parameters may cause permanent damage.
- Total power for RF and LO ports should not exceed +23 dBm.
- When pin #2 is used to increase current—see note 6 above.
- Thermal resistance ( $\theta_{jc}$ ) = +95°C/W.

## Pin Configuration

Pin #	Function	Description
1	GND	RF and DC Ground
2	RES	External current control (optional)
3	GND	RF and DC Ground
4	RF IN	RF Input of the amplifier
5	GND	RF and DC Ground
6	LO	LO port of the mixer
7	GND	RF and DC Ground
8	IF	IF port of the mixer
9	RF GND	RF and DC Ground
10	GND	RF and DC Ground
11	RF <sup>12</sup>	RF port of the mixer
12	GND	RF and DC Ground
13	RF OUT <sup>12</sup>	RF output of the amplifier
14	GND	RF and DC Ground
15	V <sub>DD</sub>	Positive supply voltage
16	GND	RF and DC Ground

- The output port of the amplifier, RFOUT, and the input port of the mixer, RF, are adjacently placed so that an external filter can be used.

Specifications subject to change without notice.

- North America: Tel. (800) 366-2266
- Asia/Pacific: Tel.+81-44-844-8296, Fax +81-44-844-8298
- Europe: Tel. +44 (1344) 869 595, Fax+44 (1344) 300 020

Visit [www.macom.com](http://www.macom.com) for additional data sheets and product information.

External Circuitry Parts <sup>13</sup>

Part	Value	Purpose
C1	47 pF	DC Block
C2	47 pF	By-pass
C3	3.3 pF	LO Port Matching Network
L1	3.9 nH	Tuning
L2	3.0 nH	LO Port Matching Network
L3	12 nH	RF Choke
R1	See Note 14	Optional Current Control
R2	5.1 k Ohms	DC Return
R3	330 Ohms	LO Port Matching Network

- 13. All external circuitry parts are readily available, low cost surface mount components (.060 in. x .030 in. or .080 in. x .050 in.).
- 14. Pin 2 allows use of an external resistor to ground for optional higher current. For 20 mA operation, no resistor is used.
  - For  $I_{DD} \gg 30$  mA,  $R2 = 43$  Ohms
  - For  $I_{DD} \gg 45$  mA,  $R2 = 15$  Ohms
  - For  $I_{DD} \gg 60$  mA,  $R2 = 10$  Ohms

Spurious Table

Harmonic of LO (n)		-12	-37	-65	-75	-75
	4X	-1.9	-39	-72	-77	-77
		-2.8	-29	-68	-66	-74
	3X	7.1	-30	-70	-77	-75
		7.0	-27	-37	-68	-74
	2X	11.8	-27	-47	-75	-75
		4.5	0	-48	-69	-74
	1X	11.8	0	-58	-76	-76
		N/A	-5	-34	-69	-70
	0X	N/A	-5	-46	-75	-70

Harmonic of RFIN (m)

The spurious table shows the spurious signals resulting from the mixing of the RFIN and LO input signals, assuming down conversion. The number of dB below the conversion loss level indicates the mixing products. The lower frequency mixing term is shown for two different input levels. The top number is for an RFIN power level of -19 dB; the lower number is for -29 dB. Assuming the LNA gain is approximately 14 dB, the mixer input will see approximately -5 dB and -15 dB.

$|mF_{RF} - nF_{LO}|$ , RF = -19 dB                      RF = 1850 MHz  
 $|mF_{RF} - nF_{LO}|$ , RF = -29 dB                      LO = 1710 MHz

Typical Performance Curves

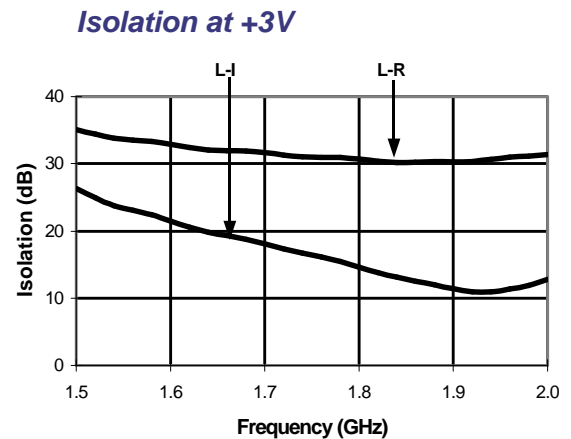
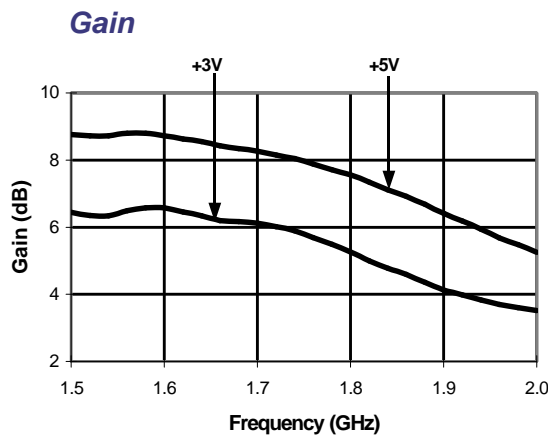

Specifications subject to change without notice.

- North America: Tel. (800) 366-2266
- Asia/Pacific: Tel.+81-44-844-8296, Fax +81-44-844-8298
- Europe: Tel. +44 (1344) 869 595, Fax+44 (1344) 300 020

Visit [www.macom.com](http://www.macom.com) for additional data sheets and product information.



### Typical Performance Curves

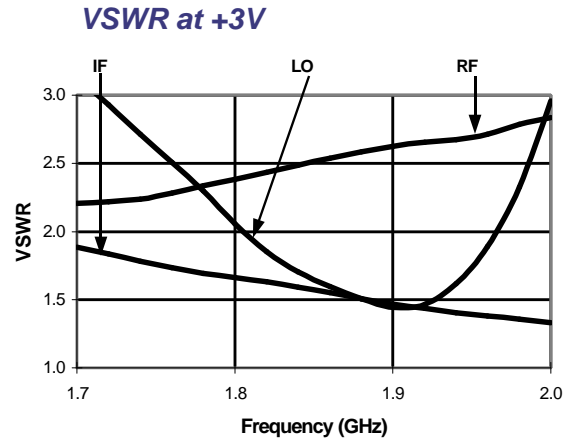
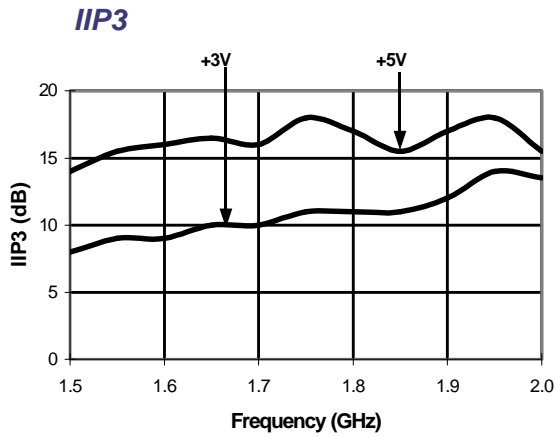

### Ordering Information

Part Number	Package
SA65-0003	Bulk Packaging
SA65-0003TR	Tape and Reel (1K Reel)
SA65-0003-TB	Units Mounted on Test Board

Specifications subject to change without notice.

- North America: Tel. (800) 366-2266
- Asia/Pacific: Tel.+81-44-844-8296, Fax +81-44-844-8298
- Europe: Tel. +44 (1344) 869 595, Fax+44 (1344) 300 020

Visit [www.macom.com](http://www.macom.com) for additional data sheets and product information.