

Property of Lite-On Only

Features

- * High Intensity.
- * Popular T-1 3/4 diameter Package.
- * Narrow viewing angle for more brightness.
- * General purpose leads.
- * Reliable and rugged.

Package Dimensions

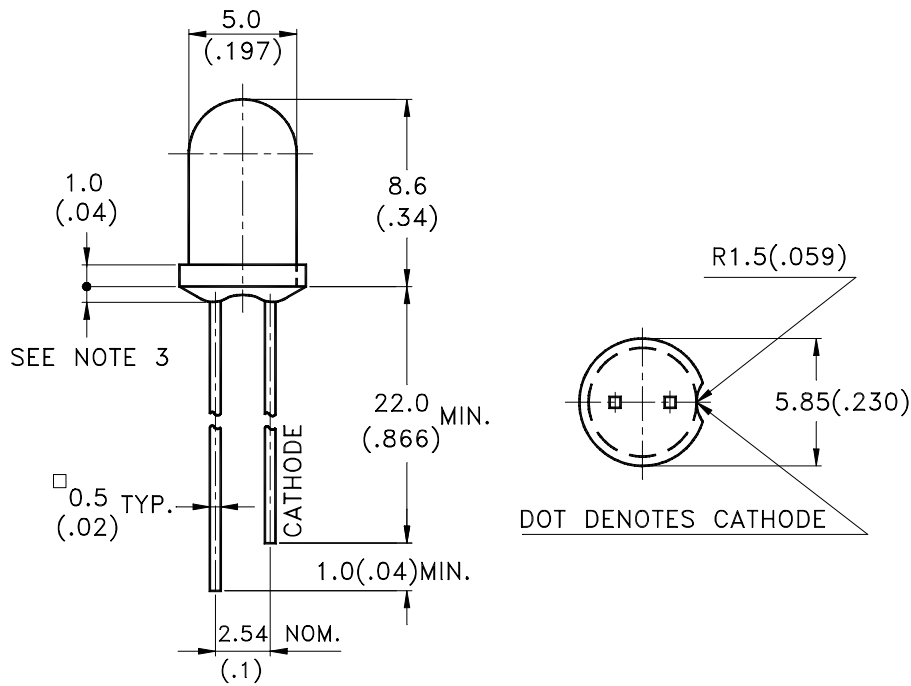

Lamp Part No.	Lens	Source Color
LTL307JGT	Green Transparent	AlInGaP Green

Notes:

1. All dimensions are in millimeters (inches).
2. Tolerance is $\pm 0.25\text{mm}(.010\text{'})$ unless otherwise noted.
3. Protruded resin under flange is 1.0mm(.04") max.
4. Lead spacing is measured where the leads emerge from the package.
5. Specifications are subject to change without notice.



LITE-ON TECHNOLOGY CORPORATION

Property of Lite-On Only

Absolute Maximum Ratings at $T_A=25^{\circ}\text{C}$

Parameter	Maximum Rating	Unit
Power Dissipation	75	mW
Peak Forward Current (1/10 Duty Cycle, 0.1ms Pulse Width)	60	mA
Continuous Forward Current	30	mA
Derating Linear From 50°C	0.4	mA/ $^{\circ}\text{C}$
Reverse Voltage	5	V
Operating Temperature Range	-40°C to $+100^{\circ}\text{C}$	
Storage Temperature Range	-55°C to $+100^{\circ}\text{C}$	
Lead Soldering Temperature [1.6mm(.063") From Body]	260°C for 5 Seconds	

Property of Lite-On Only

Electrical / Optical Characteristics at TA=25°C

Parameter	Symbol	Min.	Typ.	Max.	Unit	Test Condition
Luminous Intensity	I _v	140	310		mcd	I _F = 20mA Note 1
Viewing Angle	2θ _{1/2}		40		deg	Note 2 (Fig.5)
Peak Emission Wavelength	λ _p		574		nm	Measurement @Peak (Fig.1)
Dominant Wavelength	λ _d		572		nm	Note 4
Spectral Line Half-Width	Δλ		11		nm	
Forward Voltage	V _F		2.1	2.4	V	I _F = 20mA
Reverse Current	I _R			100	μA	V _R = 5V
Capacitance	C		40		pF	V _F = 0 , f= 1MHz

NOTE: 1. Luminous intensity is measured with a light sensor and filter combination that approximates the CIE eye-response curve.

2. θ_{1/2} is the off-axis angle at which the luminous intensity is half the axial luminous intensity.

3. I_v classification code is marked on each packing bag.

4. The dominant wavelength, λ_d is derived from the CIE chromaticity diagram and represents the single wavelength which defines the color of the device.

Property of Lite-On Only

Typical Electrical / Optical Characteristics Curves

(25°C Ambient Temperature Unless Otherwise Noted)

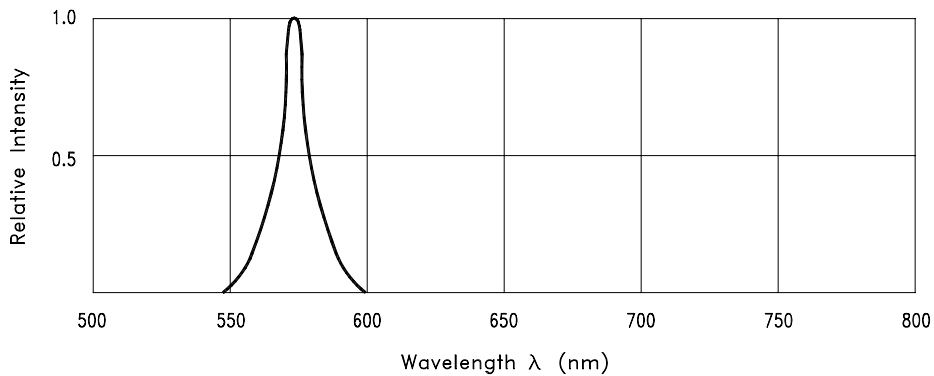

Fig.1 Relative Intensity vs. Wavelength

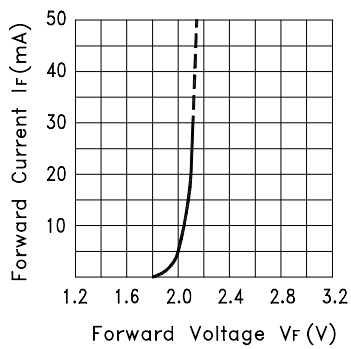

Fig.2 Forward Current vs. Forward Voltage

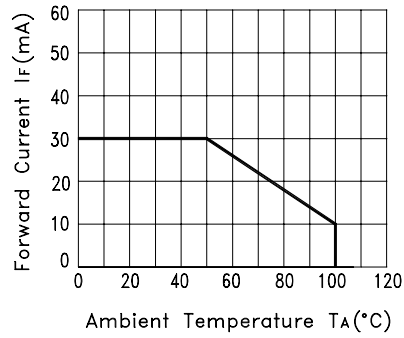

Fig.3 Forward Current Derating Curve

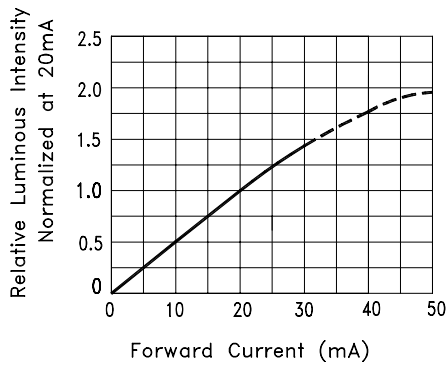

Fig.4 Relative Luminous Intensity vs. Forward Current

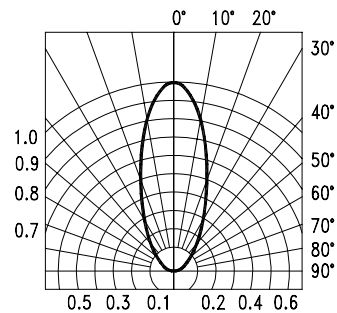

Fig.5 Spatial Distribution

CAUTIONS

1. Application limitation

The LEDs described here are intended to be used for ordinary electronic equipment (such as office equipment, communication equipment and household application.) Consult Liteon's sales in advance for information on application in which exceptional quality and reliability are required, particularly when the failure or malfunction of the LEDs may directly jeopardize life or health (such as airplanes, automobiles, traffic control equipment, life support system and safety devices).

2. Storage

After being shipped from Liteon the LEDs should be kept at 30°C or less and 70%RH or less.

The LEDs should be used within 3 months. They can be stored for a year in a sealed container with a nitrogen atmosphere and moisture absorbent material. Please avoid rapid transitions in ambient temperature in high humidity environments where condensation may occur.

3. Cleaning

Use alcohol-based cleaning solvents such as isopropyl alcohol to clean the LED.

4. Forming & Mounting

When forming a lead, the leads should be bent at a point at least 3mm from the base of epoxy bulb. Do not use the base of the leadframe as a fulcrum during forming. Lead forming must be done before soldering at normal temperature. When mounted through hole type LED lamp, avoid the occurrence of residual mechanical stress due to clinching.

5. Soldering

When soldering, leave a minimum of 2mm clearance from the resin to the soldering point.

Dipping the resin into the solder must be avoided.

Do not apply any stress to the lead frame during soldering while the LED is at high temperature.

Recommended soldering condition

Soldering iron		Wave soldering	
Temperature	300°C Max.	Pre-heat	100°C Max.
Soldering time	3 sec. Max. (one time only)	Pre-heat time	60 sec. Max.
		Solder wave	260°C Max.
		Soldering time	10 sec. Max.

*The material of hook type Housing is very sensitive of soldering temperature. Any increase of soldering temperature might seriously result in serious melting of the housing.

6. Drive Method

LED, a current operated device, requires specific current limit incorporated into the driving circuit. The current control can be achieved by using a resistor in series with the LED. In order to prevent to exceed the allowed value of 40% over desired forward current, the resistor should be well chosen for possible voltage variation. Two possible circuit designs are shown below. The circuit A is recommended, and the circuit B will probably result in uneven brightness between LEDs because of the Vf-If characteristics of LEDs.

Circuit model A

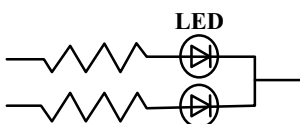

Circuit model B

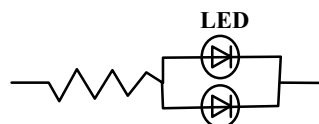

Property of Lite-On Only

7. ESD (Electrostatic Discharge)

Static electricity discharge or power surge will damage the LED. When handling the LED, it is highly recommended to use a conductive wrist band or anti-electrostatic glove. All devices, equipment and machinery must be properly grounded.

8. Reliability Test (for LED)

Classification	Test Item	Test Condition	Duration / Cycle	Reference Standard
Endurance Test	Room Temp. Operation Life	Ta= Room Temp, Ip= 160 mA / 1/8 duty, Pulse Width =1.25 ms	1000 hrs	MIL-STD-750D:1026 (1995) MIL-STD-883D:1005 (1991) JIS C 7021:B-1 (1982)
Environmental Test	Temperature Cycling	105°C ~ 25°C ~ -55°C ~ 25°C 30min 5mins 30mins 5mins	10 cycles	MIL-STD-202F:107D (1980) MIL-STD-750D:1051(1995) MIL-STD-883D:1010 (1991) JIS C 7021: A-4(1982)
	Solder Resistance	Solder temperature is 260± 5 °C	10 sec	MIL-STD-202F:210A(1980) MIL-STD-750D:2031(1995) JIS C 7021: A-1(1982)
	Solderability	Solder temperature is 230± 5 °C	5 sec	MIL-STD-202F:208D(1980) MIL-STD-750D:2026(1995) MIL-STD-883D:2003(1991) JIS C 7021: A-2(1982)

9. Others

The appearance and specifications of the product may be modified for the quality improvement without further notice.