



LIGITEK

LIGITEK ELECTRONICS CO.,LTD.  
Property of Ligitek Only

---

**LED ARRAY**

**LA09B/10Y**

**DATA SHEET**

DOC. NO : QW0905-LA09B/10Y

REV. : A

DATE : 12 - Jan - 2005



### Package Dimensions

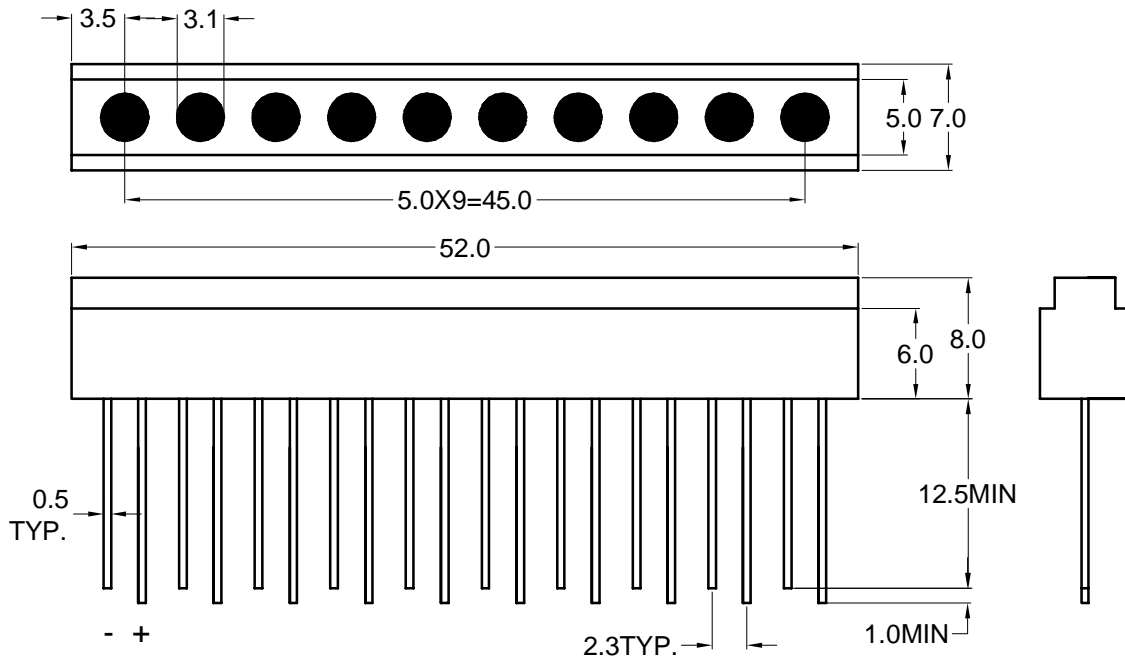

### LY4120

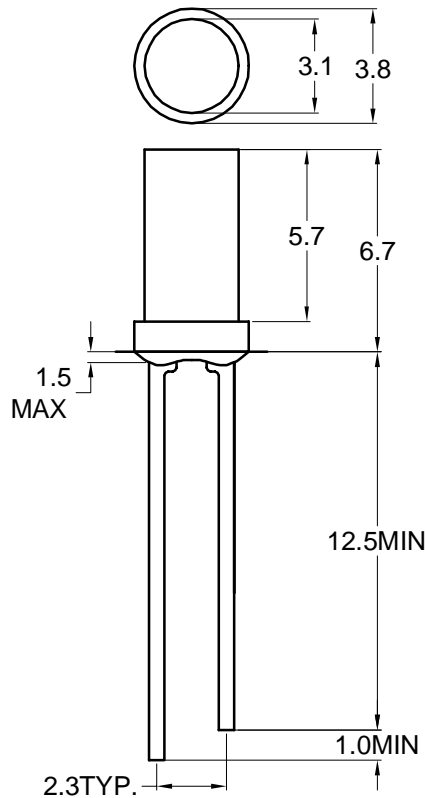

Note : 1.All dimension are in millimeter tolerance is  $\pm 0.25\text{mm}$  unless otherwise noted.  
2.Specifications are subject to change without notice.

**Absolute Maximum Ratings at Ta=25**

| Parameter                               | Symbol | Ratings                                  | UNIT |
|---|--------|--|------|
|   |        | Y  |      |
| Forward Current                         | IF     | 20                                       | mA   |
| Peak Forward Current<br>Duty 1/10@10KHz | IFP    | 80                                       | mA   |
| Power Dissipation                       | PD     | 60                                       | mW   |
| Reverse Current @5V                     | Ir     | 10                                       | μ A  |
| Operating Temperature                   | Topr   | -40 ~ +85                                |      |
| Storage Temperature                     | Tstg   | -40 ~ +100                               |      |
| Soldering Temperature                   | Tsol   | Max 260 for 5 sec Max<br>(2mm from body) |      |

**Typical Electrical & Optical Characteristics (Ta=25 )**

| PART NO   | MATERIAL  | COLOR   |                 | Peak wave length Pnm | Spectral halfwidth nm | Forward voltage @20mA(V) |      | Luminous intensity @10mA(mcd) |      | Viewing angle 2 1/2 (deg) |
|-----------|-----------|---------|-----------------|----------------------|-----------------------|--------------------------|------|-------------------------------|------|---------------------------|
|           |           | Emitted | Lens            |                      |                       | Min.                     | Max. | Min.                          | Typ. |                           |
| LA09B/10Y | GaAsP/GaP | Yellow  | Yellow Diffused | 585                  | 35                    | 1.7                      | 2.6  | 1.8                           | 3.0  | 116                       |

Note : 1.The forward voltage data did not including  $\pm 0.1V$  testing tolerance.  
2. The luminous intensity data did not including  $\pm 15\%$  testing tolerance.



### Typical Electro-Optical Characteristics Curve

Y CHIP

Fig.1 Forward current vs. Forward Voltage

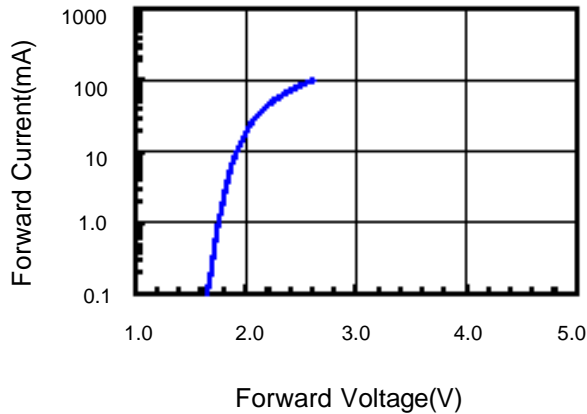

Fig.2 Relative Intensity vs. Forward Current

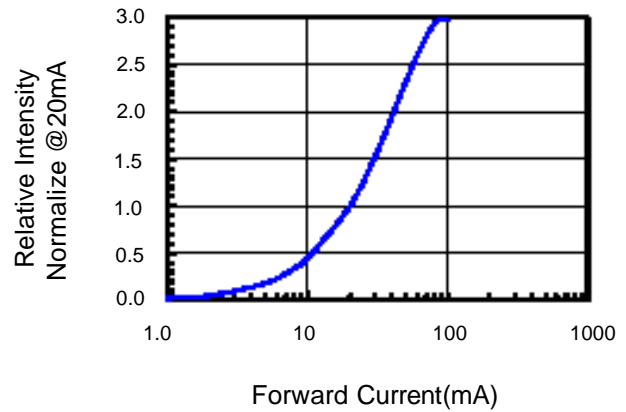

Fig.3 Forward Voltage vs. Temperature

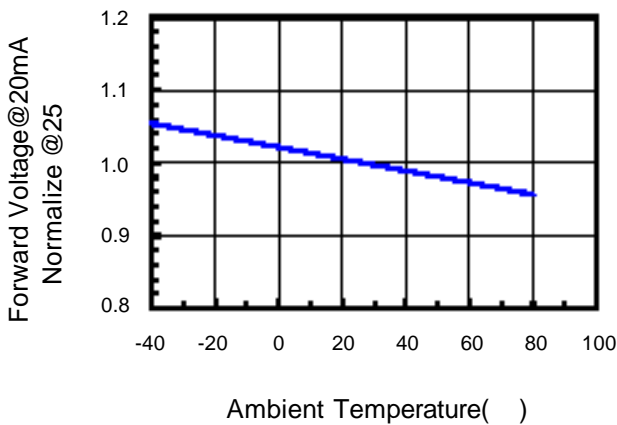

Fig.4 Relative Intensity vs. Temperature

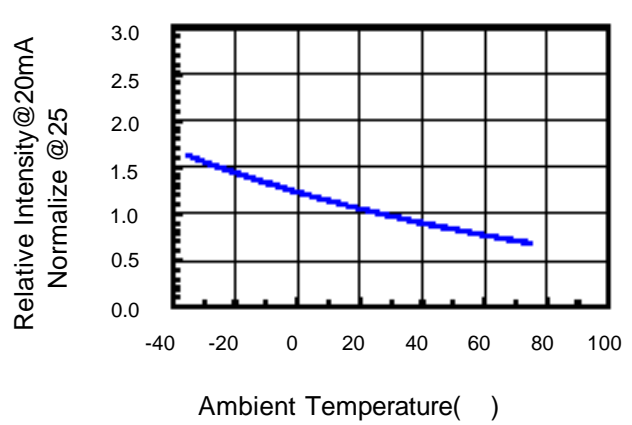
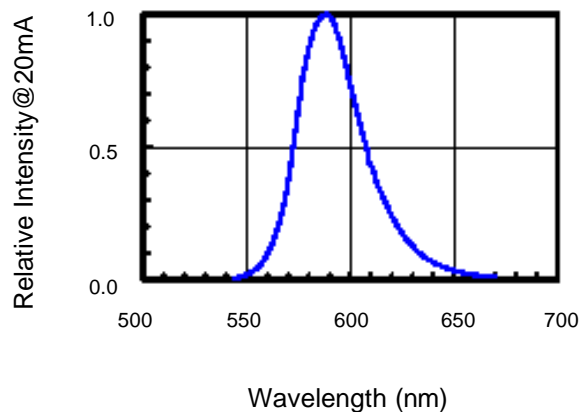

Fig.5 Relative Intensity vs. Wavelength



**Reliability Test:**

| Test Item                           | Test Condition   | Description   | Reference Standard   |
|-------------------------------------|--|---|--|
| Operating Life Test                 | 1.Under Room Temperature<br>2.If=20mA<br>3.t=1000 hrs (-24hrs, +72hrs) | This test is conducted for the purpose of determining the resistance of a part in electrical and thermal stressed.  | MIL-STD-750: 1026<br>MIL-STD-883: 1005<br>JIS C 7021: B-1                      |
| High Temperature Storage Test       | 1.Ta=105 ±5<br>2.t=1000 hrs (-24hrs, +72hrs)                           | The purpose of this is the resistance of the device which is laid under condition of high temperature for hours.  | MIL-STD-883:1008<br>JIS C 7021: B-10   |
| Low Temperature Storage Test        | 1.Ta=-40 ±5<br>2.t=1000 hrs (-24hrs, +72hrs)                           | The purpose of this is the resistance of the device which is laid under condition of low temperature for hours.   | JIS C 7021: B-12   |
| High Temperature High Humidity Test | 1.Ta=65 ±5<br>2.RH=90%~95%<br>3.t=240hrs ±2hrs                         | The purpose of this test is the resistance of the device under tropical for hours.  | MIL-STD-202:103B<br>JIS C 7021: B-11   |
| Thermal Shock Test                  | 1.Ta=105 ±5 & -40 ±5<br>(10min) (10min)<br>2.total 10 cycles           | The purpose of this is the resistance of the device to sudden extreme changes in high and low temperature.  | MIL-STD-202: 107D<br>MIL-STD-750: 1051<br>MIL-STD-883: 1011                    |
| Solder Resistance Test              | 1.T.Sol=260 ±5<br>2.Dwell time= 10 ±1sec.                              | This test intended to determine the thermal characteristic resistance of the device to sudden exposures at extreme changes in temperature when soldering the lead wire. | MIL-STD-202: 210A<br>MIL-STD-750: 2031<br>JIS C 7021: A-1                      |
| Solderability Test                  | 1.T.Sol=230 ±5<br>2.Dwell time=5 ±1sec                                 | This test intended to see soldering well performed or not.  | MIL-STD-202: 208D<br>MIL-STD-750: 2026<br>MIL-STD-883: 2003<br>JIS C 7021: A-2 |