



# 8K x 8 Power-Switched and Reprogrammable PROM

## Features

- CMOS for optimum speed/power
- Windowed for reprogrammability
- High speed
  - 20 ns (commercial)
  - 25 ns (military)
- Low power
  - 660 mW (commercial)
  - 770 mW (military)
- Super low standby power
  - Less than 85 mW when deselected
- EPROM technology 100% programmable
- 5V ±10% V<sub>CC</sub>, commercial and military

- TTL-compatible I/O
- Direct replacement for 27C64 EPROMs

## Functional Description

The CY7C266 is a high-performance 8192 word by 8 bit CMOS PROM. When deselected, the CY7C266 automatically powers down into a low-power standby mode. It is packaged in a 600-mil-wide package. The reprogrammable packages are equipped with an erasure window; when exposed to UV light, these PROMs are erased and can then be reprogrammed. The memory cells utilize proven EPROM floating-gate technology and byte-wide intelligent programming algorithms.

The CY7C266 is a plug-in replacement for EPROM devices. The EPROM cell requires only 12.5V for the super voltage and low-current requirements allow for gang programming. The EPROM cells allow for each memory location to be tested 100%, as each location is written into, erased, and repeatedly exercised prior to encapsulation. Each PROM is also tested for AC performance to guarantee that after customer programming, the product will meet DC and AC specification limits.

Reading is accomplished by placing an active LOW signal on OE and CE. The contents of the memory location addressed by the address lines (A<sub>0</sub> through A<sub>12</sub>) will become available on the output lines (O<sub>0</sub> through O<sub>7</sub>).

## Logic Block Diagram

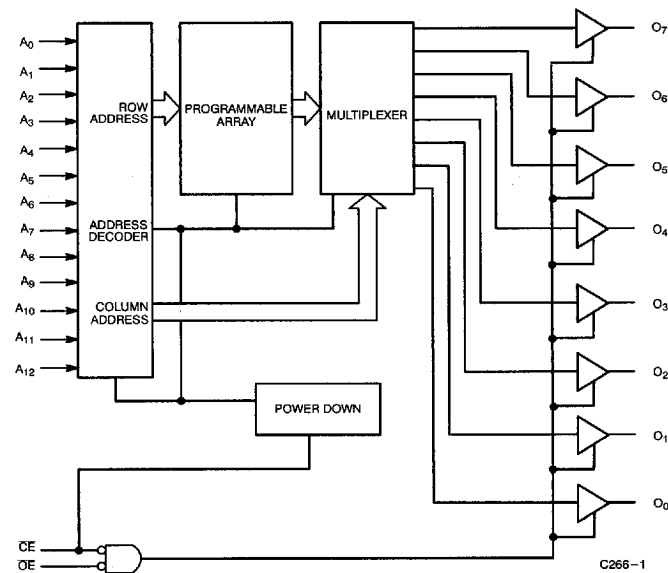

## Pin Configurations

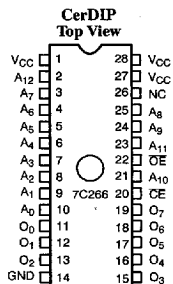

C266-2

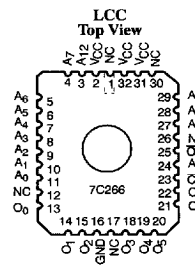

C266-3

C266-1

## Selection Guide

		7C266-20	7C266-25	7C266-35	7C266-45
Maximum Access Time (ns)		20	25	35	45
Maximum Operating Current (mA)	Commercial	120	120	100	100
	Military		140		120
Maximum Standby Current (mA)	Commercial	15	15	15	15
	Military		15		15

**Maximum Ratings**

(Above which the useful life may be impaired. For user guidelines, not tested.)

Storage Temperature .....	-65°C to +150°C
Ambient Temperature with Power Applied .....	-55°C to +125°C
Supply Voltage to Ground Potential (Pin 28 to Pin 14) .....	-0.5V to +7.0V
DC Voltage Applied to Outputs in High Z State .....	-0.5V to +7.0V
DC Input Voltage .....	-3.0V to +7.0V
DC Program Voltage .....	13.0V

Static Discharge Voltage .....	> 2001V (per MIL-STD-883, Method 3015)
Latch-Up Current .....	> 200 mA
UV Exposure .....	7258 Wsec/cm <sup>2</sup>

**Operating Range**

Range	Ambient Temperature	V <sub>CC</sub>
Commercial	0°C to +70°C	5V ± 10%
Industrial <sup>[1]</sup>	-40°C to +85°C	5V ± 10%
Military <sup>[2]</sup>	-55°C to +125°C	5V ± 10%

**Electrical Characteristics Over the Operating Range<sup>[3, 4]</sup>**

Parameter	Description	Test Conditions	7C266-20		7C266-25		Unit	
			Min.	Max.	Min.	Max.		
V <sub>OH</sub>	Output HIGH Voltage	V <sub>CC</sub> = Min., I <sub>OH</sub> = -2.0 mA	Com'l	2.4		2.4		V
			Mil			2.4		
V <sub>OL</sub>	Output LOW Voltage	V <sub>CC</sub> = Min., I <sub>OL</sub> = 8.0 mA	Com'l		0.4		0.4	V
		V <sub>CC</sub> = Min., I <sub>OL</sub> = 6.0 mA	Mil				0.4	
V <sub>IH</sub>	Input HIGH Voltage			2.0		2.0		V
V <sub>IL</sub>	Input LOW Voltage				0.8		0.8	V
I <sub>IX</sub>	Input Current	GND ≤ V <sub>IN</sub> ≤ V <sub>CC</sub>		-10	+10	-10	+10	μA
V <sub>CD</sub>	Input Diode Clamp Voltage		Note 4					
I <sub>OZ</sub>	Output Leakage Current	V <sub>OL</sub> ≤ V <sub>OUT</sub> ≤ V <sub>OH</sub> , Output Disabled		-40	+40	-40	+40	μA
I <sub>OS</sub>	Output Short Circuit Current <sup>[5]</sup>	V <sub>CC</sub> = Max., V <sub>OUT</sub> = GND		-20	-90	-20	-90	mA
I <sub>CC</sub>	Power Supply Current	V <sub>CC</sub> = Max., V <sub>IN</sub> = 2.0V, I <sub>OUT</sub> = 0 mA	Com'l		120		120	mA
			Mil				140	
I <sub>SB</sub>	Standby Supply Current	Chip Enable Inactive, CE ≥ V <sub>IH</sub> , I <sub>OUT</sub> = 0 mA	Com'l		15		15	mA
			Mil				15	

**Notes:**

- Contact a Cypress representative regarding industrial temperature range specification.
- T<sub>A</sub> is the "instant on" case temperature.
- See the last page of this specification for Group A subgroup testing information.
- See the "Introduction to CMOS PROMs" section of the Cypress Data Book for general information on testing.
- For test purposes, not more than one output at a time should be shorted. Short circuit test duration should not exceed 30 seconds.

**Electrical Characteristics** Over the Operating Range<sup>[4, 5]</sup> (continued)

Parameter	Description	Test Conditions	7C266-35		7C266-45		Unit	
			Min.	Max.	Min.	Max.		
V <sub>OH</sub>	Output HIGH Voltage	V <sub>CC</sub> = Min., I <sub>OH</sub> = -4.0 mA	2.4		2.4		V	
V <sub>OL</sub>	Output LOW Voltage	V <sub>CC</sub> = Min., I <sub>OL</sub> = 16.0 mA		0.4		0.4	V	
V <sub>IH</sub>	Input HIGH Voltage		2.0		2.0		V	
V <sub>IL</sub>	Input LOW Voltage			0.8		0.8	V	
I <sub>IX</sub>	Input Current	GND ≤ V <sub>IN</sub> ≤ V <sub>CC</sub>	-10	+10	-10	+10	μA	
V <sub>CD</sub>	Input Diode Clamp Voltage		Note 4					
I <sub>OZ</sub>	Output Leakage Current	V <sub>OL</sub> ≤ V <sub>OUT</sub> ≤ V <sub>OH</sub> , Output Disabled	-10	+10	-10	+10	μA	
I <sub>OS</sub>	Output Short Circuit Current <sup>[5]</sup>	V <sub>CC</sub> = Max., V <sub>OUT</sub> = GND	-20	-90	-20	-90	mA	
I <sub>CC</sub>	Power Supply Current	V <sub>CC</sub> = Max., V <sub>IN</sub> = 2.0V, I <sub>OUT</sub> = 0 mA	Com'1		100		100	mA
			Mil				120	
I <sub>SB</sub>	Standby Supply Current	Chip Enable Inactive, CE ≥ V <sub>IH</sub> , I <sub>OUT</sub> = 0 mA	Com'1		15		15	mA
			Mil				15	

**Capacitance<sup>[5]</sup>**

Parameter	Description	Test Conditions	Max.	Unit
C <sub>IN</sub>	Input Capacitance	T <sub>A</sub> = 25°C, f = 1 MHz, V <sub>CC</sub> = 5.0V	10	pF
C <sub>OUT</sub>	Output Capacitance		10	pF

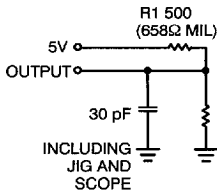
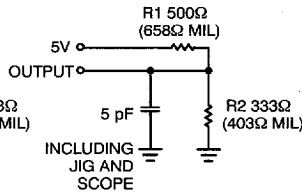
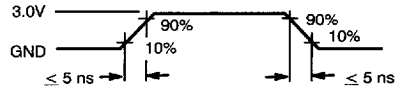
**AC Test Loads and Waveforms**
**Test Load for -20 through -25 speeds**

**(a) Normal Load**

**(b) High Z Load**

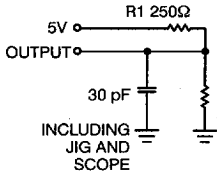
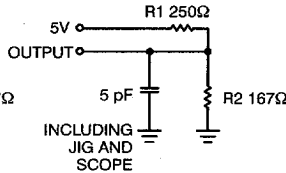
C266-5

Equivalent to: THEVENIN EQUIVALENT

**Test Load for -35 through -55 speeds**

**(c) Normal Load**

**(d) High Z Load**

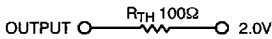
C266-6

Equivalent to: THEVENIN EQUIVALENT

**Switching Characteristics Over the Operating Range<sup>[2,3,5]</sup>**

Parameter	Description	7C266-20		7C266-25		7C266-35		7C266-45		Unit
		Min.	Max.	Min.	Max.	Min.	Max.	Min.	Max.	
$t_{AA}$	Address to Output Valid		20		25		35		45	ns
$t_{HZCE}$	Chip Enable Inactive to High Z		25		30		40		45	ns
$t_{HZOE}$	Output Enable Inactive to High Z		12		12		20		25	ns
$t_{AOE}$	Output Enable Active to Output Valid		12		12		20		25	ns
$t_{ACE}$	Chip Enable Active to Output Valid		25		30		40		45	ns
$t_{OHA}$	Data Hold from Address Change	3		3		3		3		ns
$t_{PU}$	Chip Enable Active to Power-Up		25		30		40		45	ns
$t_{PD}$	Chip Enable Inactive to Power-Down		25		30		40		45	ns

### Erase Characteristics

Wavelengths of light less than 4000 Å begin to erase the devices in the windowed package. For this reason, an opaque label should be placed over the window if the EPROM is exposed to sunlight or fluorescent lighting for extended periods of time.

The recommended dose of ultraviolet light for erasure is a wavelength of 2537 Å for a minimum dose (UV intensity multiplied by exposure time) of 25 Wsec/cm<sup>2</sup>. For an ultraviolet lamp with a 12 mW/cm<sup>2</sup> power rating, the exposure time would be approximately 35 minutes. The CY7C266 needs to be within 1 inch of the lamp during erasure. Permanent damage may result if the EPROM is

exposed to high-intensity UV light for an extended period of time.

7258 Wsec/cm<sup>2</sup> is the recommended maximum dosage.

### Programming Modes

Programming support is available from Cypress as well as from a number of third party software vendors. For detailed programming information, including a listing of software packages, please see the PROM Programming Information located at the end of this section. Programming algorithms can be obtained from any Cypress representative.

Table 1. Mode Selection

Mode	Pin Function <sup>[6, 7]</sup>								
	Normal Operation	A <sub>8</sub>	A <sub>9</sub>	A <sub>10</sub>	A <sub>11</sub>	A <sub>12</sub>	CE	OE	D <sub>7</sub> - D <sub>0</sub>
Program	VFY	PGM	LAT	NA	NA	NA	CE	V <sub>PP</sub>	D <sub>7</sub> - D <sub>0</sub>
Read	A <sub>8</sub>	A <sub>9</sub>	A <sub>10</sub>	A <sub>11</sub>	A <sub>12</sub>	V <sub>IL</sub>	V <sub>IL</sub>	V <sub>IL</sub>	O <sub>7</sub> - O <sub>0</sub>
Standby	X	X	X	X	X	V <sub>IH</sub>	X	X	Three-States
Output Disable	A <sub>8</sub>	A <sub>9</sub>	A <sub>10</sub>	A <sub>11</sub>	A <sub>12</sub>	V <sub>IL</sub>	V <sub>IH</sub>	V <sub>IH</sub>	Three-States
Program	V <sub>IHP</sub>	V <sub>ILP</sub>	V <sub>ILP</sub>	V <sub>ILP</sub>	V <sub>ILP</sub>	V <sub>ILP</sub>	V <sub>ILP</sub>	V <sub>PP</sub>	D <sub>7</sub> - D <sub>0</sub>
Program Verify	V <sub>ILP</sub>	V <sub>IHP</sub>	V <sub>ILP</sub>	V <sub>ILP</sub>	V <sub>ILP</sub>	V <sub>ILP</sub>	V <sub>ILP</sub>	V <sub>PP</sub>	O <sub>7</sub> - O <sub>0</sub>
Program Inhibit	V <sub>IHP</sub>	V <sub>IHP</sub>	V <sub>ILP</sub>	V <sub>ILP</sub>	V <sub>ILP</sub>	V <sub>ILP</sub>	V <sub>ILP</sub>	V <sub>PP</sub>	Three-States
Blank Check	V <sub>ILP</sub>	V <sub>IHP</sub>	V <sub>ILP</sub>	V <sub>ILP</sub>	V <sub>ILP</sub>	V <sub>ILP</sub>	V <sub>ILP</sub>	V <sub>PP</sub>	O <sub>7</sub> - O <sub>0</sub>

Notes:

6. X = "don't care" but must not exceed V<sub>CC</sub> + 5%.

7. Address A<sub>8</sub> - A<sub>12</sub> must be latched through lines A<sub>0</sub> - A<sub>4</sub> in Programming modes.

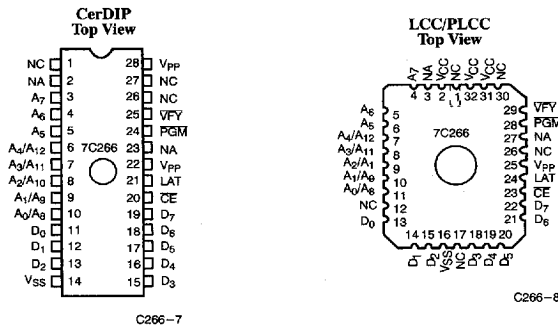
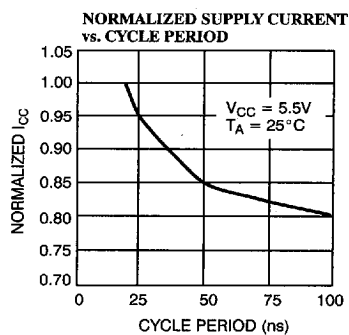
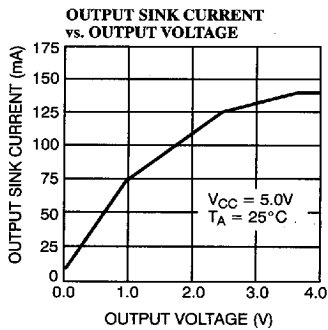
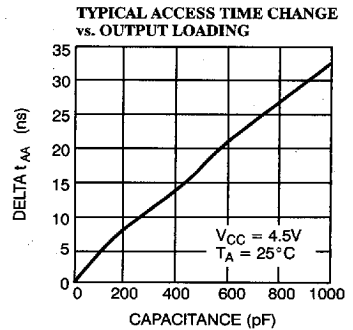
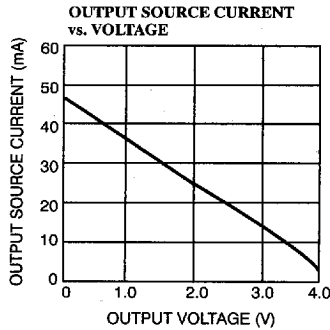
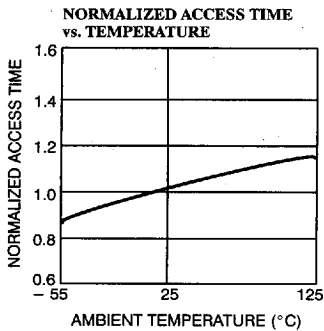
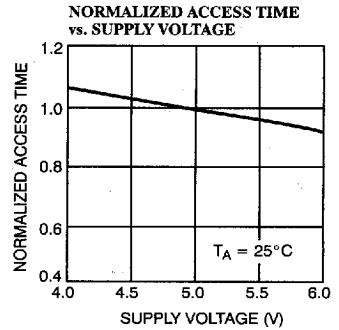
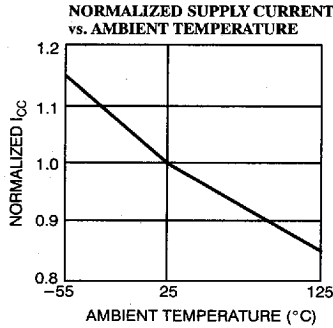
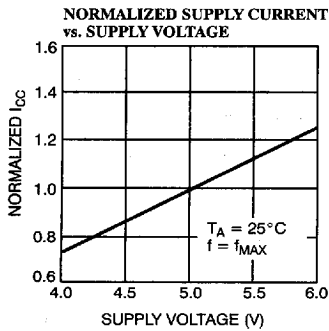

Figure 1. Programming Pinout

**Typical DC and AC Characteristics**

**Ordering Information<sup>[8]</sup>**

Speed (ns)	Ordering Code	Package Name	Package Type	Operating Range
20	CY7C266-20PC	P15	28-Lead (600-Mil) Molded DIP	Commercial
	CY7C266-20WC	W16	28-Lead (600-Mil) Windowed CerDIP	
25	CY7C266-25PC	P15	28-Lead (600-Mil) Molded DIP	Commercial
	CY7C266-25WC	W16	28-Lead (600-Mil) Windowed CerDIP	
	CY7C266-25DMB	D16	28-Lead (600-Mil) CerDIP	Military
	CY7C266-25LMB	L55	32-Pin Rectangular Leadless Chip Carrier	
	CY7C266-25QMB	Q55	32-Pin Windowed Rectangular Leadless Chip Carrier	
	CY7C266-25WMB	W16	28-Lead (600-Mil) Windowed CerDIP	
35	CY7C266-35PC	P15	28-Lead (600-Mil) Molded DIP	Commercial
	CY7C266-35WC	W16	28-Lead (600-Mil) Windowed CerDIP	
45	CY7C266-45PC	P15	28-Lead (600-Mil) Molded DIP	Commercial
	CY7C266-45WC	W16	28-Lead (600-Mil) Windowed CerDIP	
	CY7C266-45DMB	D16	28-Lead (600-Mil) CerDIP	Military
	CY7C266-45LMB	L55	32-Pin Rectangular Leadless Chip Carrier	
	CY7C266-45QMB	Q55	32-Pin Windowed Rectangular Leadless Chip Carrier	
	CY7C266-45WMB	W16	28-Lead (600-Mil) Windowed CerDIP	

**Note:**

9. Most of these products are available in industrial temperature range. Contact a Cypress representative for specifications and product availability.

**MILITARY SPECIFICATIONS**
**Group A Subgroup Testing**
**DC Characteristics**

Parameter	Subgroups
V <sub>OH</sub>	1, 2, 3
V <sub>OL</sub>	1, 2, 3
V <sub>IH</sub>	1, 2, 3
V <sub>IL</sub>	1, 2, 3
I <sub>Ix</sub>	1, 2, 3
I <sub>OZ</sub>	1, 2, 3
I <sub>CC</sub>	1, 2, 3
I <sub>SB</sub>	1, 2, 3

**Switching Characteristics**

Parameter	Subgroups
t <sub>AA</sub>	7, 8, 9, 10, 11
t <sub>AOE</sub>	7, 8, 9, 10, 11
t <sub>ACE</sub>	7, 8, 9, 10, 11

Document #: 38-00086-D