



Features

- 5W Output Power (P1dB)
- High Linearity: OIP3 > 48dBm
- High Efficiency
- Low Noise: NF=4dB at 945MHz
- 5V to 7V Operation
- Thermally Enhanced Slug Package

Applications

- GaAs Driver for Base Station Amplifiers
- PA Stage for Commercial Wireless Infrastructure
- Final Stage PA in Femtocell and Repeater Applications
- Final Stage PA in High Efficiency, High Power Applications
- Class AB Operation for LTE and GSM Transceiver Applications

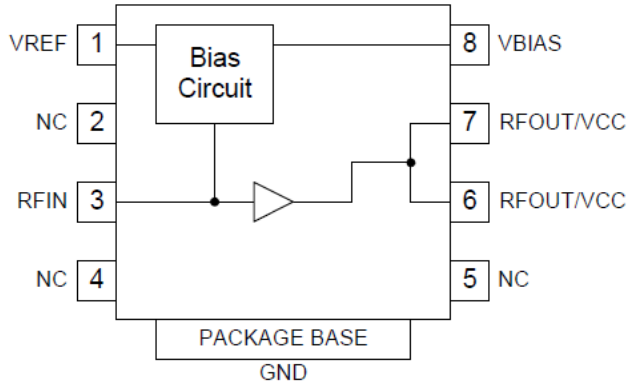

Functional Block Diagram

Product Description

The RFPA3800 is a single-stage GaAs HBT power amplifier specifically designed for high power, high efficiency applications. It is also well-suited for Wireless Infrastructure linear power amplifier applications. The RFPA3800 can be optimized for linear or saturated operation by varying the quiescent bias point and load line. It also offers low noise figure making it an excellent solution for 2nd and 3rd stage LNAs. The RFPA3800 exhibits excellent thermal performance through the use of a thermally-enhanced plastic surface-mount slug package.

Ordering Information

RFPA3800SQ	Sample bag with 25 pieces
RFPA3800SR	7" Reel with 100 pieces
RFPA3800TR7	7" Reel with 750 pieces
RFPA3800TR13	13" Reel with 2500 pieces
RFPA3800PCK-410	450MHz to 470MHz PCBA with 5-piece Sample Bag
RFPA3800PCK-411	920MHz to 960MHz PCBA with 5-piece Sample Bag

Optimum Technology Matching® Applied

- | | | | |
|--|--------------------------------------|-------------------------------------|------------------------------------|
| <input checked="" type="checkbox"/> GaAs HBT | <input type="checkbox"/> SiGe BiCMOS | <input type="checkbox"/> GaAs pHEMT | <input type="checkbox"/> GaN HEMT |
| <input type="checkbox"/> GaAs MESFET | <input type="checkbox"/> Si BiCMOS | <input type="checkbox"/> Si CMOS | <input type="checkbox"/> BIFET HBT |
| <input type="checkbox"/> InGaP HBT | <input type="checkbox"/> SiGe HBT | <input type="checkbox"/> Si BJT | <input type="checkbox"/> LDMOS |

RF MICRO DEVICES®, RFMD®, Optimum Technology Matching®, Enabling Wireless Connectivity™, PowerStart®, POLARIS™ TOTAL RADIO™ and UltimateBlue™ are trademarks of RFMD, LLC. BLUETOOTH is a trademark owned by Bluetooth SIG, Inc., U.S.A. and licensed for use by RFMD. All other trade names, trademarks and registered trademarks are the property of their respective owners. ©2006, RF Micro Devices, Inc.

Absolute Maximum Ratings

Parameter	Rating	Unit
Supply Voltage (V_{CC} and V_{BIAS}) >300MHz	7.5	V
Supply Voltage (V_{CC} and V_{BIAS}) <300MHz	5.5	V
Reference Current (I_{REF})	10	mA
DC Supply Current (I_C)	2300	mA
CW Input Power, 2:1 Output VSWR	28	dBm
CW Input Power, 5:1 Output VSWR	20	dBm
Output Load VSWR at P3db	5:1	
Operating Junction Temperature	160	°C
Operating Temperature Range (T_L)	-40 to +85	°C
Storage Temperature	-55 to +150	°C
ESD Rating: Human Body Model	Class 1B	
Moisture Sensitivity Level	MSL 2	



Caution! ESD sensitive device.

Exceeding any one or a combination of the Absolute Maximum Rating conditions may cause permanent damage to the device. Extended application of Absolute Maximum Rating conditions to the device may reduce device reliability. Specified typical performance or functional operation of the device under Absolute Maximum Rating conditions is not implied.

RoHS status based on EUDirective2002/95/EC (at time of this document revision).

The information in this publication is believed to be accurate and reliable. However, no responsibility is assumed by RF Micro Devices, Inc. ("RFMD") for its use, nor for any infringement of patents, or other rights of third parties, resulting from its use. No license is granted by implication or otherwise under any patent or patent rights of RFMD. RFMD reserves the right to change component circuitry, recommended application circuitry and specifications at any time without prior notice.

Parameter	Specification			Unit	Condition
	Min.	Typ.	Max.		
460MHz					$V_{CC}=7.0V$, $V_{BIAS}=7.0V$, $I_{CQ}=650mA$
Frequency	450	460	470	MHz	EVB tuned for linear operation
Input Power (P_{IN})			23	dBm	$V_{CC}<7.5V$, load VSWR < 2:1
Gain (S21)		18		dB	
OIP3		48		dBm	20dBm/tone, tone spacing=1MHz
P1dB		36.7		dBm	EVB tuned for linear operation
Efficiency at P3dB		50		%	At P3dB, EVB tuned for linear operation
Input Return Loss (S11)		15		dB	
Output Return Loss (S22)		9		dB	
Noise Figure		5		dB	
WCDMA Ch Power at -65dBc ACPR		19.5		dBm	3GPP 3.5, Test Model 1, 64 DPCH
WCDMA Ch Power at -55dBc ACPR		24.5		dBm	3GPP 3.5, Test Model 1, 64 DPCH
945MHz					$V_{CC}=7.0V$, $V_{BIAS}=7.0V$, $I_{CQ}=650mA$
Frequency	920	940	960	MHz	EVB tuned for linear operation
Input Power (P_{IN})			26	dBm	$V_{CC}<7.5V$, load VSWR < 2:1
Gain (S21)	12	13.5	15.0	dB	945MHz
OIP3		48		dBm	20dBm/tone, tone spacing=1MHz
P1dB		36		dBm	EVB tuned for linear operation
Efficiency at P3dB		45		%	At P3dB, EVB tuned for linear operation
Input Return Loss (S11)		13		dB	
Output Return Loss (S22)		10		dB	
Noise Figure		4		dB	
WCDMA Ch Power at -65dBc ACPR		19.5		dBm	3GPP 3.5, Test Model 1, 64 DPCH
WCDMA Ch Power at -55dBc ACPR		24.5		dBm	3GPP 3.5, Test Model 1, 64 DPCH
Power Supply					
Operating Current (Quiescent)	500	650	700	mA	At $V_{CC}=7.0V$
Operating Voltage (V_{CC})		7.0	7.5	V	Max recommended collector voltage
Thermal Resistance (R_{TH})		11.5		C/W	At quiescent current, no RF
Power Down Current			20	μA	At $V_{REF}=0V$.

Typical Performance

(450MHz to 470MHz Application Circuit)

S11 versus Frequency

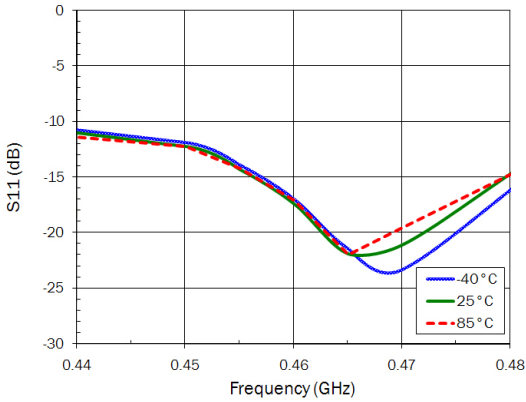

S21 versus Frequency

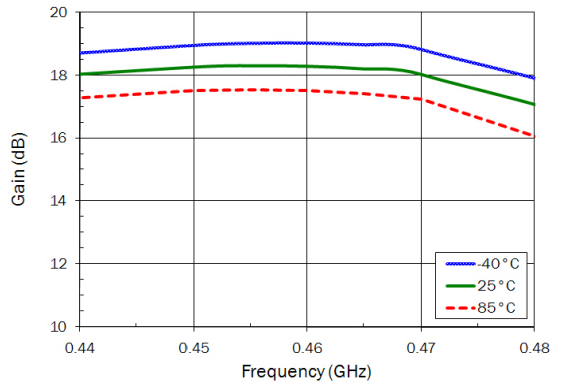

S12 versus Frequency

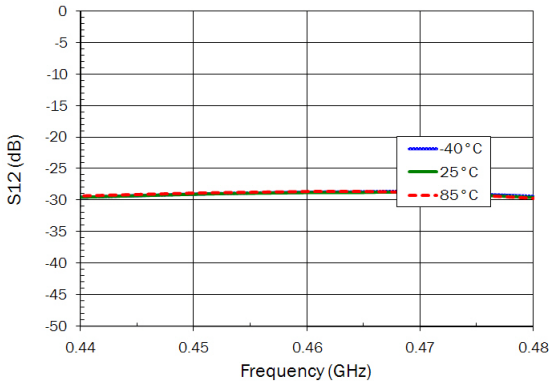

S22 versus Frequency

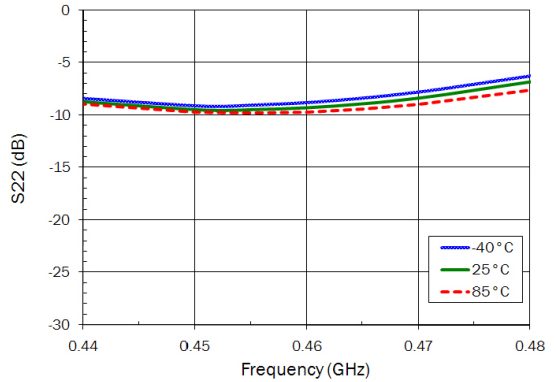

Noise Figure versus Frequency

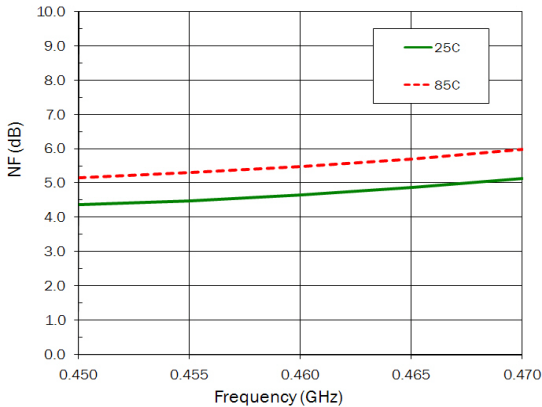

P1dB versus Frequency

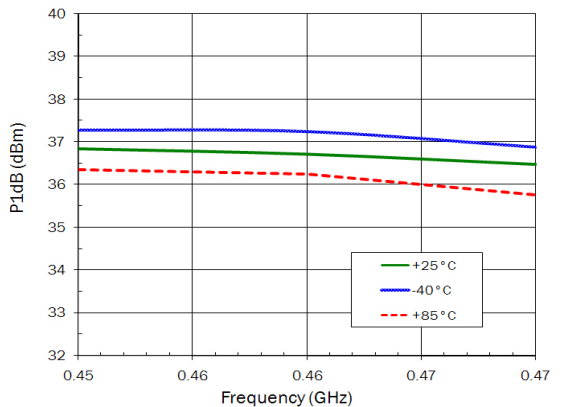

Typical Performance (450MHz to 470MHz Application Circuit)

Pout versus Pin @460MHz

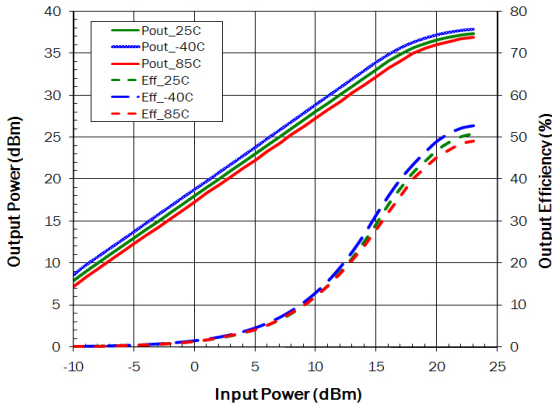

ACP versus W-CDMA Channel Power (460MHz)

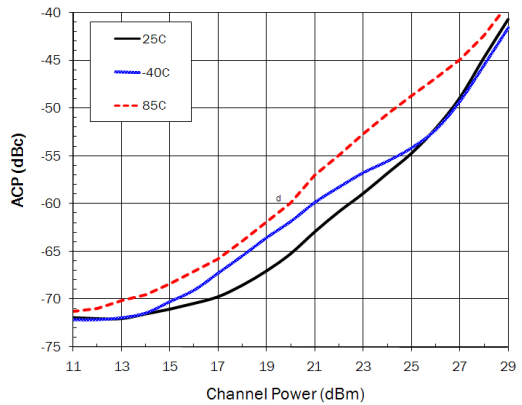

ACP versus W-CDMA Channel Power, 25C

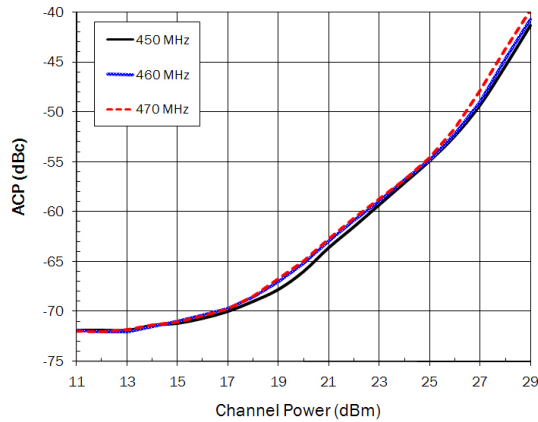

Evaluation Board Schematic
(450MHz to 470MHz Application Circuit)

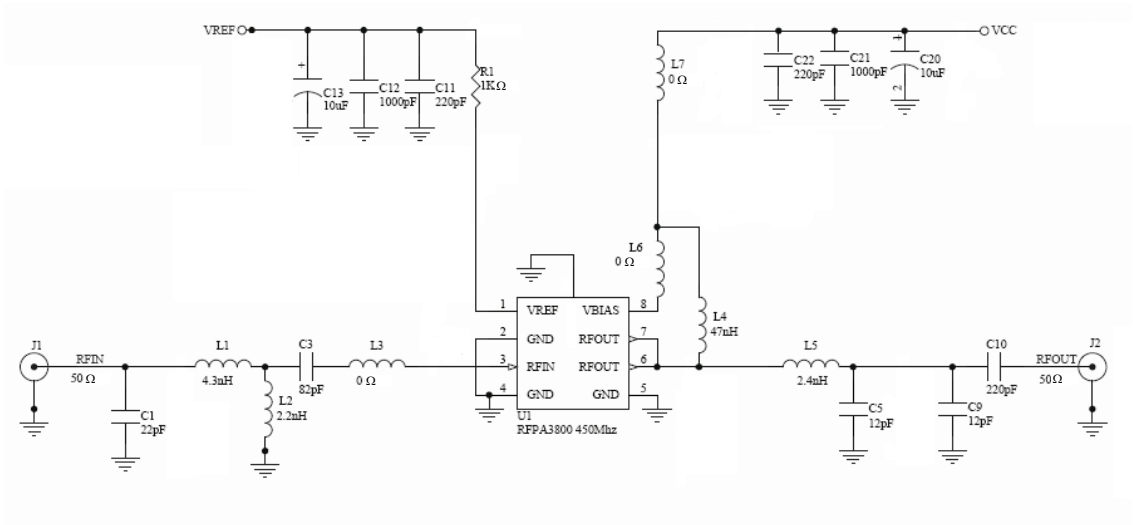

EVB BOM (450 MHz to 470 MHz Application Circuit)

Description	Reference Designator	Manufacturer	Manufacturer's P/N
PCB		DDI	RFPA3800410(A)
RFPA3800	U1	RFMD	RFPA3800
RES, 1K, 1%, 1/16W, 0603	R1	Panasonic Industrial CO	ERJ-3EKF1001V
RES, 5.1K, 5%, 1/16W, 0402	C1	Kamaya, Inc	RMC1/16S-512JTH
CAP, 1.5pF, +/-0.1pF, 50V, HI-Q, 0402	C2	Johanson Technology	500R07S1R5BV4TD
CAP, 10uF, 20%, 10V, TANT-A	C13, C20	Kemet	T491A106M010AT
CAP, 15pF, 2%, 50V, HI-Q, 0402	C4	Johanson Technology	500R07S150GV4TD
CAP, 27pF, 2%, 50V, HI-Q, 0402	C3	Johanson Technology	500R07S270GV4TD
CAP, 100pF, 5%, 50V, COG, 0402	C10	Murata Electronics	GRM1555C1H101JZ01D
CAP, 5.6pF, +/-0.1pF, 50V, HI-Q, 0402	C6	Johanson Technology	500R07S5R6BV4TD
CAP, 0.5pF, +/-0.1pF, 50V, HI-Q, 0402	C7	Johanson Technology	500R07S0R5BV4TD
CAP, 220pF, 10%, 50V, X7R, 0402	C11, C22	Murata Electronics North America, I	GRM155R71H221KA01E
CAP, 1000pF, 10%, 50V, X7R, 0402	C12, C21	Murata Electronics	GRM155R71H102KA01E
CAP, 7.5pF, +/-0.1pF, 50V, HI-Q, 0402	L1	Johanson Technology	500R07S7R5BV4TD
CAP, 9.1pF, +/-0.1pF, 50V, HI-Q, 0402	L2	Johanson Technology	500R07S9R1BV4TD
RES, 0 OHM, 0402	L7,L3	Kamaya, Inc	RMC1/16SJPTH
IND, 47nH, 5%, W/W, 0603	L4	Coilcraft	0603HC-47NXJLW
IND, 1.2nH, +/-0.1nH, T/F, 0402	L5	Murata Electronics North America, I	LQP15MN1N2B02D
IND, 150nH, 5%, W/W, 0603	L6	Coilcraft	0603CS-R15XJBC
CONN, BANANA JACK, RED	P1, P2	Johnson Co	108-0902-001
CONN, BANANA JACK, BLACK	P3	Johnson Co	108-0903-001
CONN, SMA, ST JACK REC, FLNG MT, T/H	J1, J2	Johnson Co	142-0701-631
HEATSINK, POWER CELL	MP1		2020048-2
2-56 SS socket head screws, 3/16 long	S1, S2, S3, S4, S5, S6, S7, S8, S9, S10	McMaster-Carr	92196A076
DNP	C5*, C8*, C9*, C14*, C16*, C17*, C18, C19*, C23*, C24*, C25*, C26*, C27*		
DNP	R2*, R3*, R4*, R5*		
DNP	L8*		

Typical Performance

(920MHz to 960MHz Application Circuit)

S11 versus Frequency

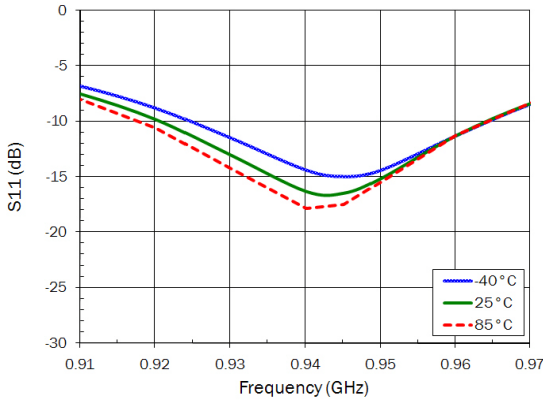

S21 versus Frequency

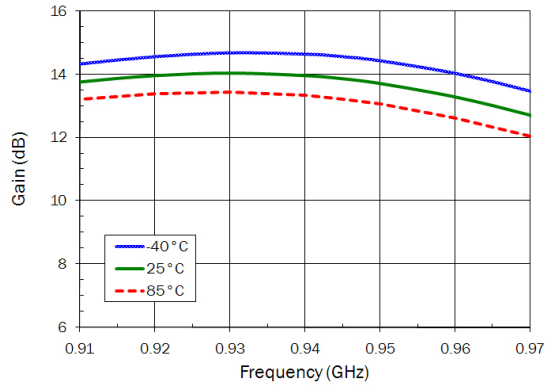

S12 versus Frequency

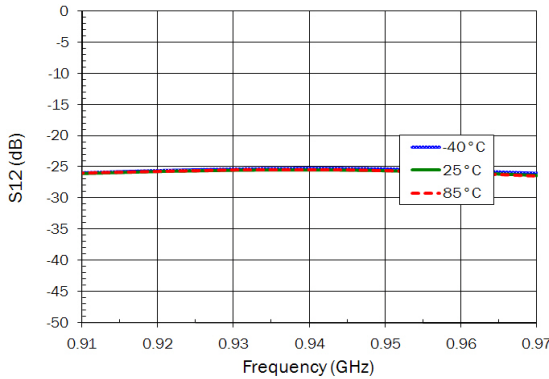

S22 versus Frequency

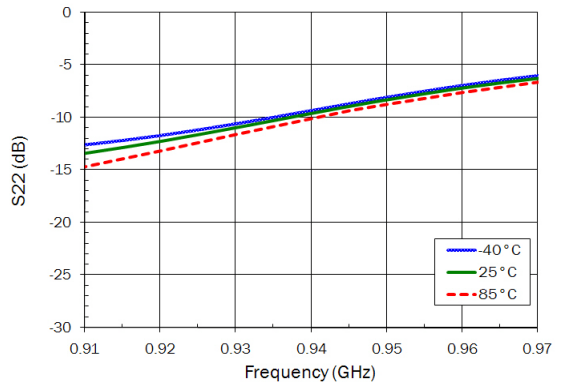

Noise Figure versus Frequency

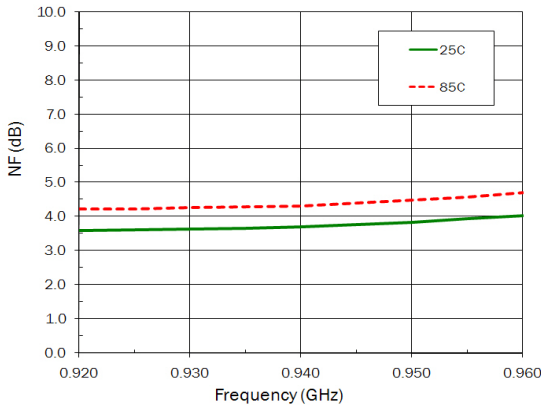

P1dB versus Frequency

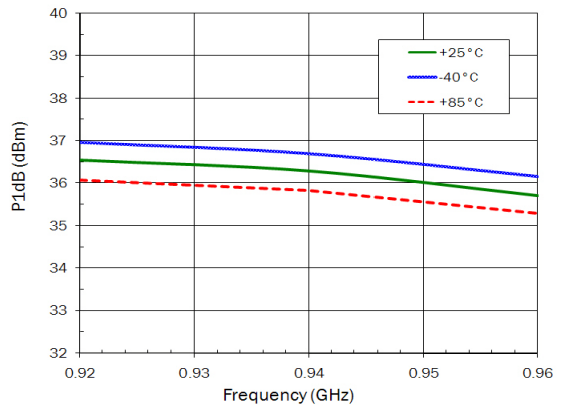

Typical Performance (920 MHz to 960 MHz Application Circuit)

Pout versus Pin @ 940MHz

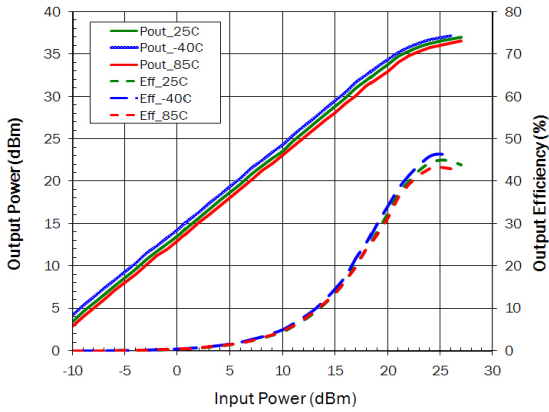

ACP versus W-CDMA Channel Power (940MHz)

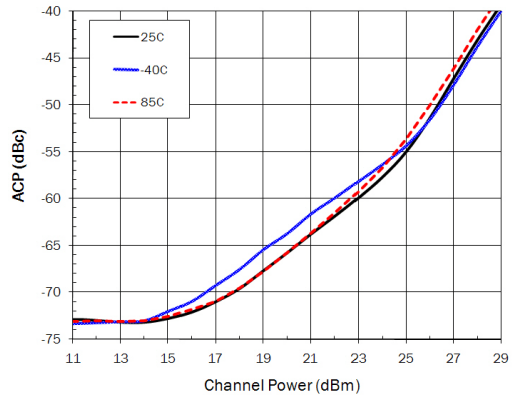

ACP versus W-CDMA Channel Power, 25C

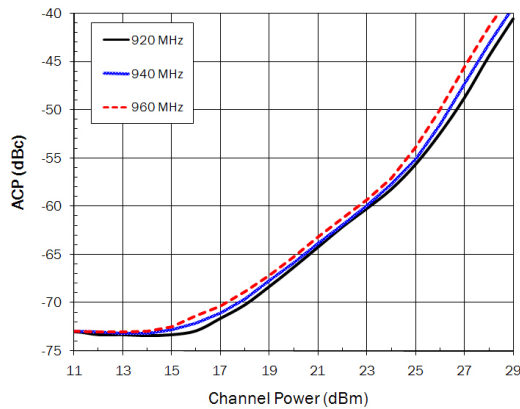

Evaluation Board Schematic
(920MHz to 960MHz Application Circuit)

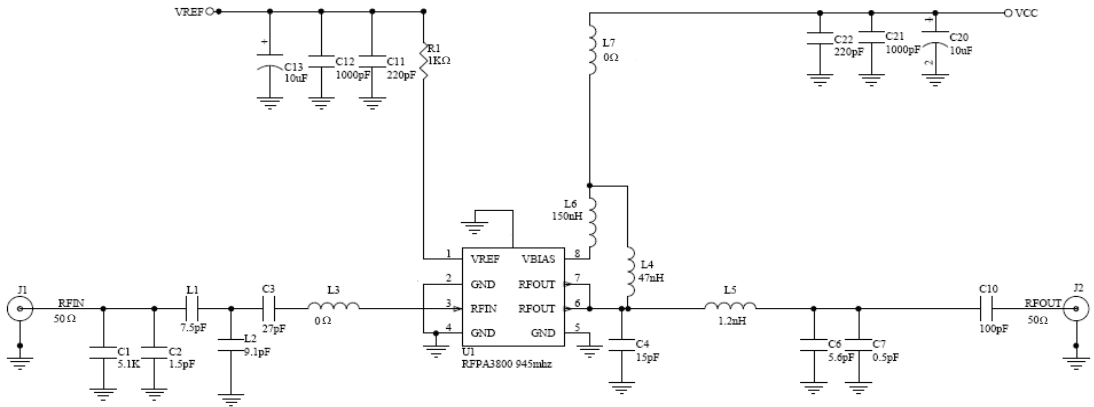

EVB BOM (920 MHz to 960 MHz Application Circuit)

Description	Reference Designator	Manufacturer	Manufacturer's P/N
PCB		DDI	RFPA3800410(A)
RFPA3800	U1	RFMD	RFPA3800
RES, 1K, 1%, 1/16W, 0603	R1	PANASONIC INDUS- TRIAL CO	ERJ-3EKF1001V
CAP, 10uF, 20%, 10V, TANT-A	C13, C20	Kemet	T491A106M010AT
CAP, 22pF, 5%, 50V, COG, 0402	C1		GRM1555C1H220JZ01E
CAP, 12pF, 2%, 50V, HI-Q, 0402	C5, C9	Johanson Technology	500R07S120GV4TD
CAP, 82pF, 5%, 50V, COG, 0402	C3	Murata Electronics North America	GRM1555C1H820JZ01D
CAP, 220pF, 10%, 50V, X7R, 0402	C10, C11, C22	Murata Electronics North America, I	GRM155R71H221KA01E
CAP, 1000pF, 10%, 50V, X7R, 0402	C12, C21	Murata Electronics	GRM155R71H102KA01E
IND, 4.3nH, +/-0.1nH, T/F, 0402	L1	Murata Electronics	LQP15MN4N3B02D
IND, 2.4nH, +/-0.1nH, T/F, 0402	L5	Murata Electronics	LQP15MN2N4B02D
IND, 2.2nH, +/-0.1nH, T/F, 0402	L2	Murata Electronics	LQP15MN2N2B02D
RES, 0 OHM, 0402	L3, L6, L7	Kamaya, Inc	RMC1/16SJPTH
IND, 47nH, 5%, W/W, 0603	L4	Coilcraft	0603HC-47NXJLW
CONN, BANANA JACK, RED	P1, P2	JOHNSON CO	108-0902-001
CONN, BANANA JACK, BLACK	P3	JOHNSON CO	108-0903-001
CONN, SMA, ST JACK REC, FLNG MT, T/H	J1, J2	JOHNSON CO	142-0701-631
HEATSINK, POWER CELL	MP1		2020048-2
2-56 SS socket head screws, 3/16 long	S1, S2, S3, S4, S5, S6, S7, S8, S9, S10	McMaster-Carr	92196A076
DNP	C2*, C4*, C6*, C7*, C8*, C14*, C16*, C17*, C18*, C19*, C23*, C24*, C25*, C26*, C27*		
DNP	R2*, R3*, R4*, R5*		
DNP	L8*		

Evaluation Board Assembly Drawing

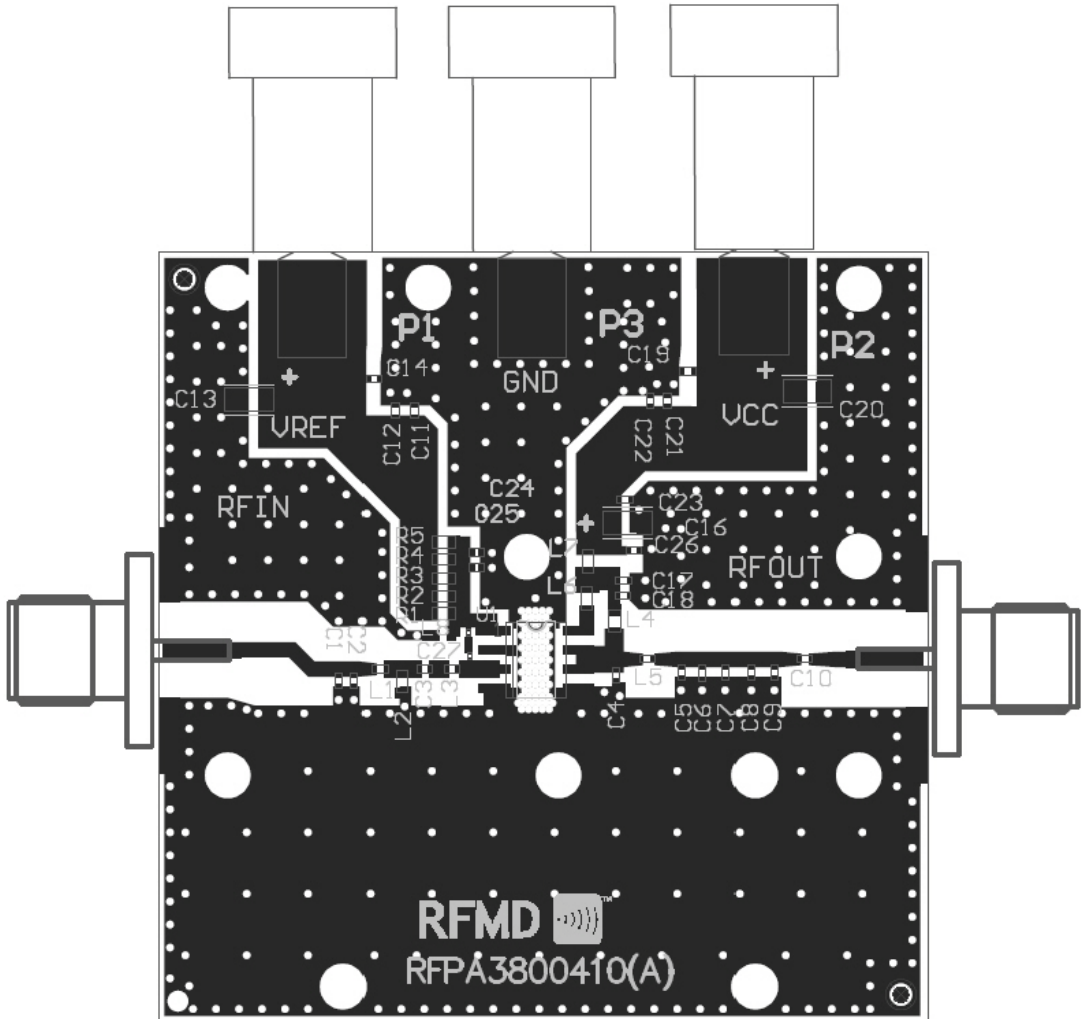

Pin	Function	Description
1	VREF	Control input to the active bias circuit to set I_{CC} . Can be used as a power-down pin.
2	NC	No connection.
3	RF IN	RF input. External DC block is required.
4	NC	No connection.
5	NC	No connection.
6	RF OUT/VCC	RF output, device collector.
7	RF OUT/VCC	RF output, device collector.
8	VBIAS	Supply voltage for the active bias circuit.
EPAD	GND	DC and RF ground. Must be soldered to EVB ground plane over a bed of vias for thermal and RF performance.

Package Drawing

Dimensions in inches (millimeters)

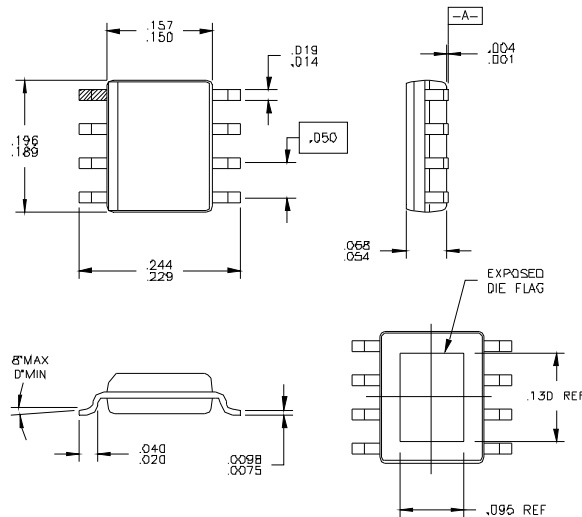

Branding Diagram

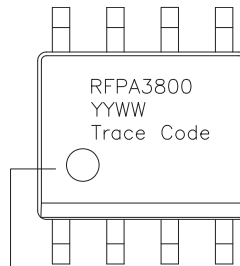

Pin 1 Indicator

YYWW = Date Code, YY = year, WW = week

Trace Code assigned by SubCon