

## Features

- Lead free as standard
- RoHS compliant\*
- Glass passivated chip
- Low reverse leakage current
- Low forward voltage drop
- High current capability

## CD214B-R350~R31000 Glass Passivated Rectifiers

### General Information

The markets of portable communications, computing and video equipment are challenging the semiconductor industry to develop increasingly smaller electronic components. Bourns offers Glass Passivated Rectifiers for rectification applications, in compact chip DO-214AA (SMB) size format, which offer PCB real estate savings and are considerably smaller than most competitive parts. The Glass Passivated Rectifier Diodes offer a forward current of 3.0 A with a choice of repetitive peak reverse voltage of 50 V up to 1000 V.

Bourns® Chip Diodes conform to JEDEC standards, are easy to handle on standard pick and place equipment and their flat configuration minimizes roll away.

### Electrical Characteristics (@ $T_A = 25\text{ }^\circ\text{C}$ Unless Otherwise Noted)

Parameter	Symbol	CD214B-							Unit
		R350	R3100	R3200	R3400	R3600	R3800	R31000	
Maximum Repetitive Peak Reverse Voltage	$V_{RRM}$	50	100	200	400	600	800	1000	V
Maximum RMS Voltage	$V_{RMS}$	35	70	140	280	420	560	700	V
Maximum DC Blocking Voltage	$V_{DC}$	50	100	200	400	600	800	1000	V
Max. Average Forward Rectified Current <sup>1</sup>	$I_{(AV)}$	3.0							A
DC Reverse Current @ Rated DC Blocking Voltage (@ $T_J = 25\text{ }^\circ\text{C}$ )	$I_R$	5.0							$\mu\text{A}$
DC Reverse Current @ Rated DC Blocking Voltage (@ $T_J = 125\text{ }^\circ\text{C}$ )	$I_R$	50							$\mu\text{A}$
Typical Junction Capacitance <sup>2</sup>	$C_J$	40							pF
Maximum Instantaneous Forward Voltage @ 1 A	$V_F$	1.0							V
Typical Thermal Resistance <sup>3</sup>	$R_{\theta JL}$	13							$^\circ\text{C/W}$
Peak forward surge current 8.3 ms single half sine-wave superimposed on rated load (JEDEC Method)	$I_{FSM}$	115							A

Notes:

1 See Forward Derating Curve.

2 Measured @ 1.0 MHz and applied reverse voltage of 4.0 VDC.

3 Thermal resistance from junction to ambient and from junction to lead P.C.B. mounted on 0.2" x 0.2" (5.0 mm x 5.0 mm) copper pad areas.

### Thermal Characteristics (@ $T_A = 25\text{ }^\circ\text{C}$ Unless Otherwise Noted)

Parameter	Symbol	CD214B-R350~R31000	Unit
Operating Temperature Range	$T_J$	-65 to +175	$^\circ\text{C}$
Storage Temperature Range	$T_{STG}$	-65 to +175	$^\circ\text{C}$

\*RoHS Directive 2002/95/EC Jan 27 2003 including Annex

Specifications are subject to change without notice.

Customers should verify actual device performance in their specific applications.

# CD214B-R350~R31000 Glass Passivated Rectifiers

**BOURNS®**

## Product Dimensions

This is a lead free product. It is a molded plastic package. A cathode band indicates the polarity. The package weighs approximately 0.064 g. The package and dimensions are shown below.

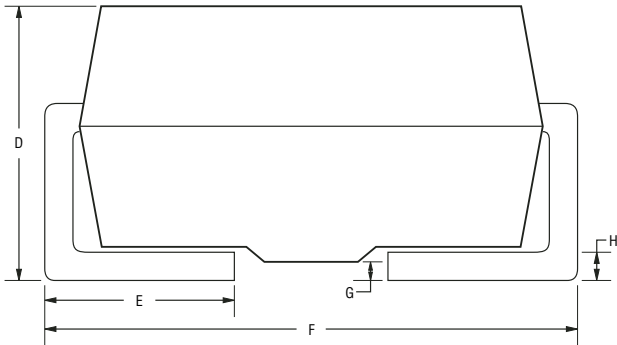
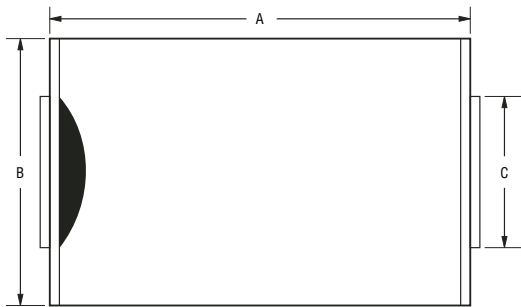

Dimensions	
A	$\frac{4.06 - 4.57}{(0.167 - 0.187)}$
B	$\frac{3.30 - 3.94}{(0.130 - 0.150)}$
C	$\frac{1.96 - 2.21}{(0.075 - 0.087)}$
D	$\frac{2.01 - 2.62}{(0.079 - 0.096)}$
E	$\frac{0.76 - 1.52}{(0.039 - 0.055)}$
F	$\frac{5.21 - 5.59}{(0.197 - 0.236)}$
G	$\frac{0.05 - 0.20}{(0.00196 - 0.00787)}$
H	$\frac{0.15 - 0.31}{(0.006 - 0.016)}$

DIMENSIONS:  $\frac{\text{MM}}{\text{(INCHES)}}$

## Recommended Pad Layout

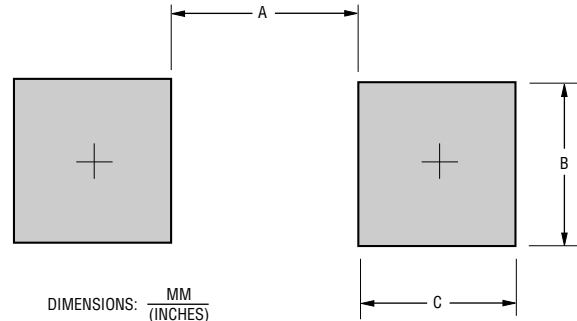

DIMENSIONS:  $\frac{\text{MM}}{\text{(INCHES)}}$

Dimension	SMB (DO-214AA)
A (Max.)	$\frac{2.69}{(0.106)}$
B (Min.)	$\frac{2.10}{(0.083)}$
C (Min.)	$\frac{1.27}{(0.050)}$

## How To Order

**CD 214B - R 3 50**

Common Code \_\_\_\_\_  
 Chip Diode \_\_\_\_\_  
 Package \_\_\_\_\_  
 • 214B = SMB/DO-214AA  
 Model \_\_\_\_\_  
 R = Glass Passivated Rectifiers  
 Forward Current  $I_{AV}$  \_\_\_\_\_  
 3 = 3 A  
 Reverse Voltage \_\_\_\_\_  
 50 = 50 V  
 100 = 100 V  
 200 = 200 V  
 400 = 400 V  
 600 = 600 V  
 800 = 800 V  
 1000 = 1000 V

\*RoHS Directive 2002/95/EC Jan 27 2003 including Annex Specifications are subject to change without notice. Customers should verify actual device performance in their specific applications.

# CD214B-R350~R31000 Glass Passivated Rectifiers



## Rating and Characteristic Curves

### Forward Current Derating Curve

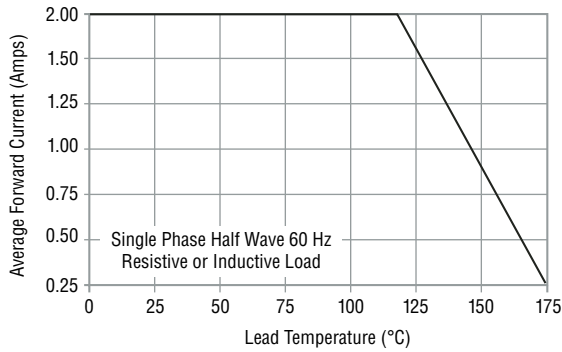

### Non-Repetitive Surge Current

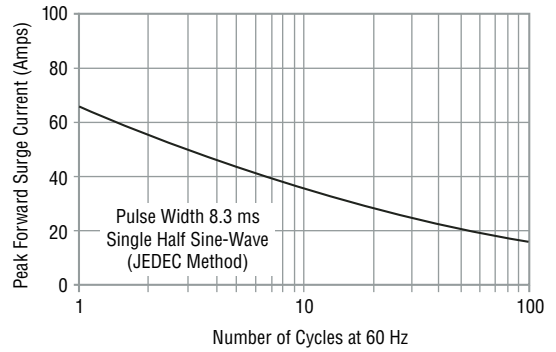

### Forward Characteristics

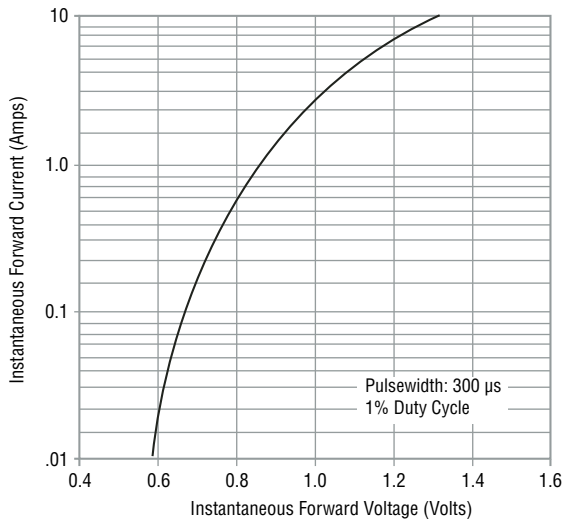

### Reverse Characteristics

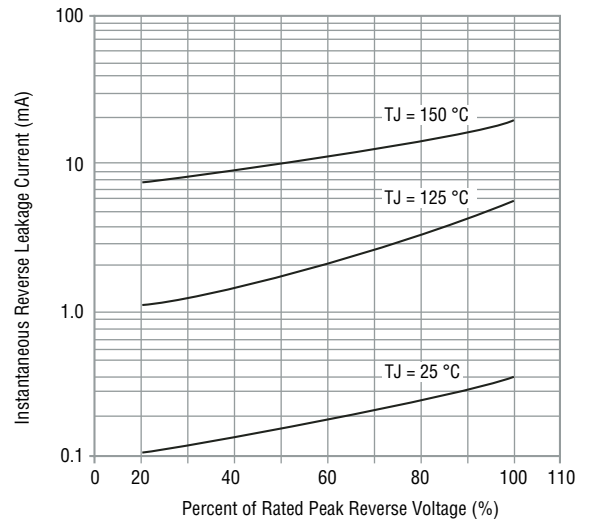

\*RoHS Directive 2002/95/EC Jan 27 2003 including Annex  
Specifications are subject to change without notice.  
Customers should verify actual device performance in their specific applications.

# CD214B-R350~R31000 Glass Passivated Rectifiers

**BOURNS®**

## Packaging Information

The surface mount product is packaged in an 8 mm x 4 mm tape and reel format per EIA-481 standard.

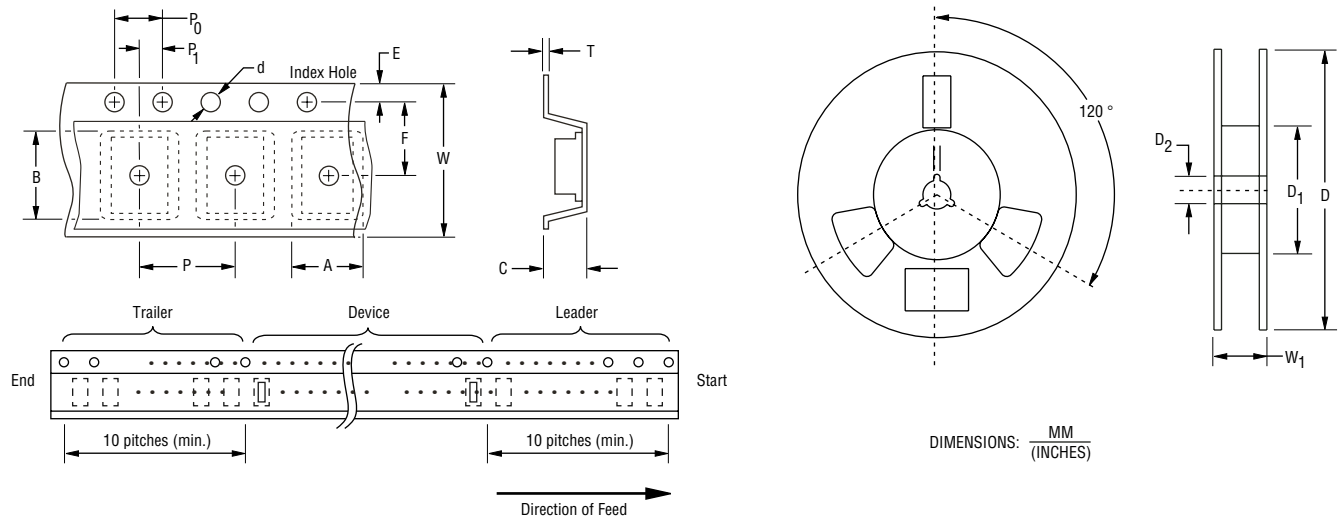

Item	Symbol	DO-214AA (SMB)
Carrier Width	A	$\frac{1.90 \pm 0.10}{(0.075 - 0.004)}$
Carrier Length	B	$\frac{4.30 \pm 0.10}{(0.169 - 0.004)}$
Carrier Depth	C	$\frac{1.80 \pm 0.10}{(0.071 - 0.004)}$
Sprocket Hole	d	$\frac{1.55 \pm 0.05}{(0.061 - 0.002)}$
Reel Outside Diameter	D	$\frac{178}{(7.008)}$
Reel Inner Diameter	D <sub>1</sub>	$\frac{80.0}{(3.150)}$ Min.
Feed Hole Diameter	D <sub>2</sub>	$\frac{13.0 \pm 0.20}{(0.512 - 0.008)}$
Sprocket Hole Position	E	$\frac{1.75 \pm 0.10}{(0.069 - 0.004)}$
Punch Hole Position	F	$\frac{3.50 \pm 0.05}{(0.138 - 0.002)}$
Punch Hole Pitch	P	$\frac{4.00 \pm 0.10}{(0.157 - 0.004)}$
Sprocket Hole Pitch	P <sub>0</sub>	$\frac{4.00 \pm 0.10}{(0.157 - 0.004)}$
Embossment Center	P <sub>1</sub>	$\frac{2.00 \pm 0.05}{(0.079 - 0.002)}$
Overall Tape Thickness	T	$\frac{0.20 \pm 0.10}{(0.008 - 0.004)}$
Tape Width	W	$\frac{8.00 \pm 0.20}{(0.315 - 0.008)}$
Reel Width	W <sub>1</sub>	$\frac{13.5}{(0.531)}$ Max.
Quantity per Reel	—	2,500



*Reliable Electronic Solutions*

**Asia-Pacific:**

Tel: +886-2 2562-4117 • Fax: +886-2 2562-4116

**Europe:**

Tel: +41-41 768 5555 • Fax: +41-41 768 5510

**The Americas:**

Tel: +1-951 781-5500 • Fax: +1-951 781-5700

[www.bourns.com](http://www.bourns.com)

\*RoHS Directive 2002/95/EC Jan 27 2003 including Annex Specifications are subject to change without notice. Customers should verify actual device performance in their specific applications. COPYRIGHT© 2005, BOURNS, INC. LITHO IN U.S.A. IPA0501 10/05