

Silicon PNP Power Transistors

2SA1220 2SA1220A

**DESCRIPTION**

- With TO-126 package
- Complement to type 2SC2690/2690A

**APPLICATIONS**

- Audio frequency power amplifier
- High frequency power amplifier

**PINNING**

PIN	DESCRIPTION
1	Emitter
2	Collector;connected to mounting base
3	Base

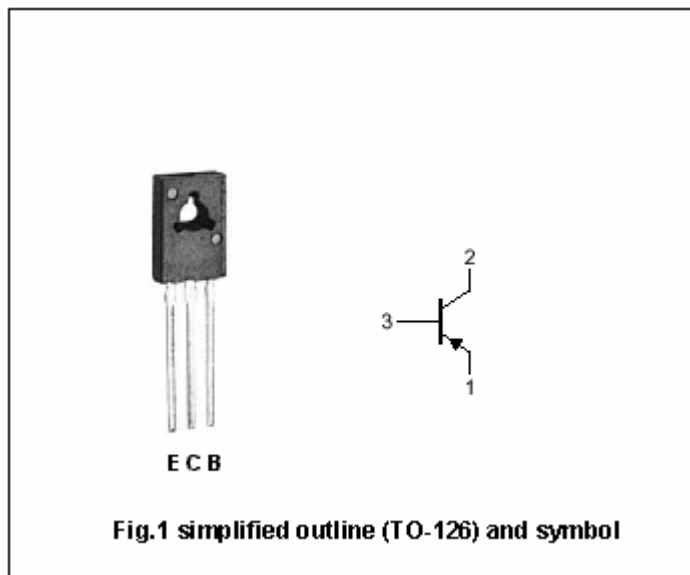

**Absolute maximum ratings(Ta=25°C)**

SYMBOL	PARAMETER	CONDITIONS	VALUE	UNIT
V <sub>CB0</sub>	Collector-base voltage	2SA1220	-120	V
		2SA1220A	-160	
V <sub>CEO</sub>	Collector-emitter voltage	2SA1220	-120	V
		2SA1220A	-160	
V <sub>EBO</sub>	Emitter-base voltage	Open collector	-5	V
I <sub>C</sub>	Collector current		-1.2	A
I <sub>CM</sub>	Collector current-peak		-2.5	A
I <sub>B</sub>	Base current		-0.3	A
P <sub>D</sub>	Total power dissipation	T <sub>a</sub> =25°C	1.2	W
		T <sub>C</sub> =25°C	20	
T <sub>j</sub>	Junction temperature		150	°C
T <sub>stg</sub>	Storage temperature		-55°C+150	°C

## Silicon PNP Power Transistors

## 2SA1220 2SA1220A

## CHARACTERISTICS

T<sub>j</sub>=25 °C unless otherwise specified

SYMBOL	PARAMETER	CONDITIONS	MIN	TYP.	MAX	UNIT
V <sub>CEsat</sub>	Collector-emitter saturation voltage	I <sub>C</sub> =-1A; I <sub>B</sub> =-0.2A			-0.7	V
V <sub>BEsat</sub>	Base-emitter saturation voltage	I <sub>C</sub> =-1A; I <sub>B</sub> =-0.2A			-1.3	V
I <sub>CBO</sub>	Collector cut-off current	V <sub>CB</sub> =-120V; I <sub>E</sub> =0			-1	μA
I <sub>EBO</sub>	Emitter cut-off current	V <sub>EB</sub> =-3V; I <sub>C</sub> =0			-1	μA
h <sub>FE-1</sub>	DC current gain	I <sub>C</sub> =-5mA; V <sub>CE</sub> =-5V	35			
h <sub>FE-2</sub>	DC current gain	I <sub>C</sub> =-0.3A; V <sub>CE</sub> =-5V	60		320	
C <sub>ob</sub>	Output capacitance	I <sub>E</sub> =0; V <sub>CB</sub> =-10V f=1MHz		26		pF
f <sub>T</sub>	Transition frequency	I <sub>C</sub> =-0.2A; V <sub>CE</sub> =5V		175		MHz

◆ h<sub>FE-2</sub> Classifications

R	Q	P
60-120	100-200	160-320

Silicon PNP Power Transistors

2SA1220 2SA1220A

PACKAGE OUTLINE

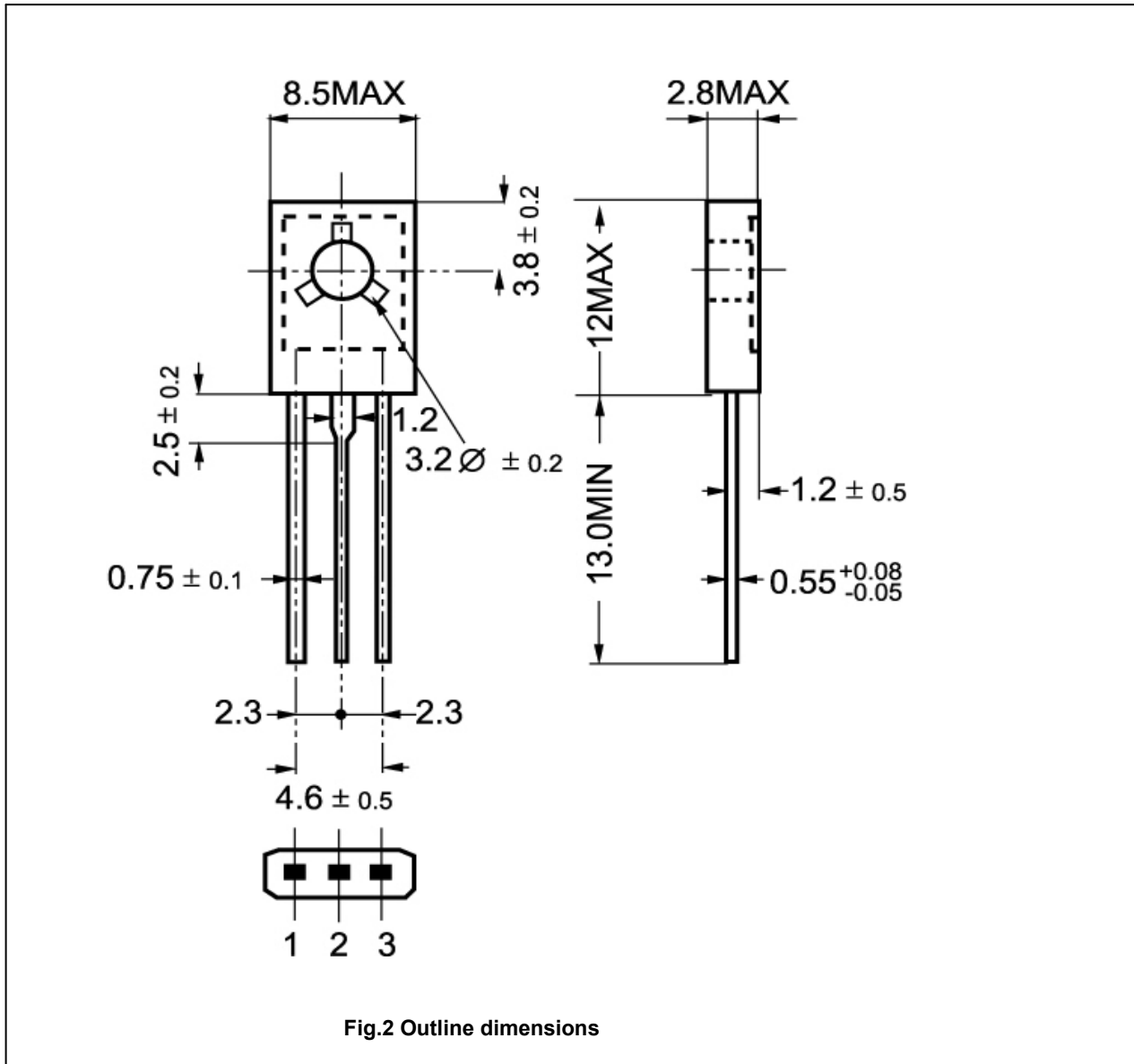

Silicon PNP Power Transistors

2SA1220 2SA1220A

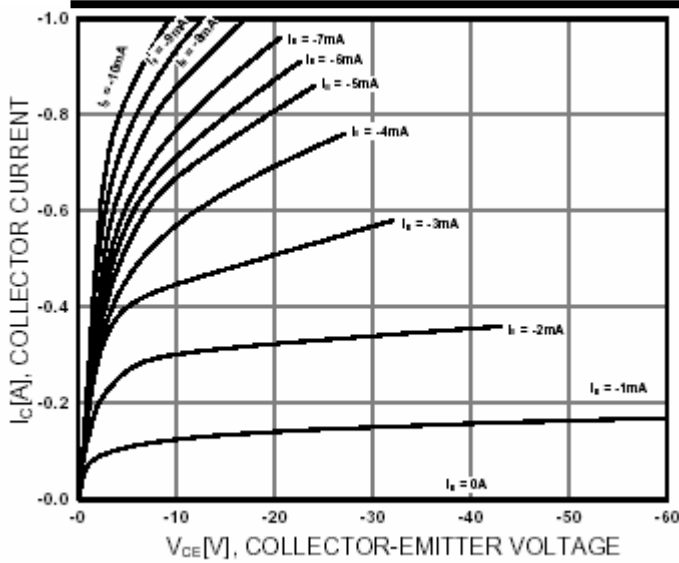

Fig.3 Static Characteristic

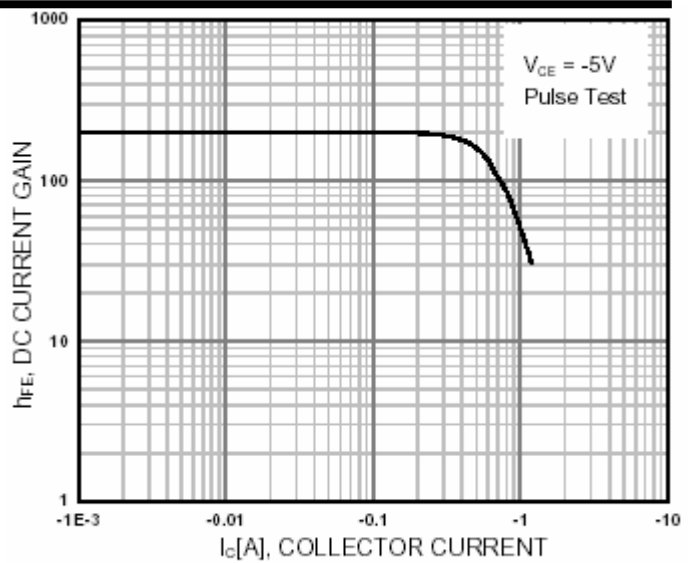

Fig.4 DC current Gain

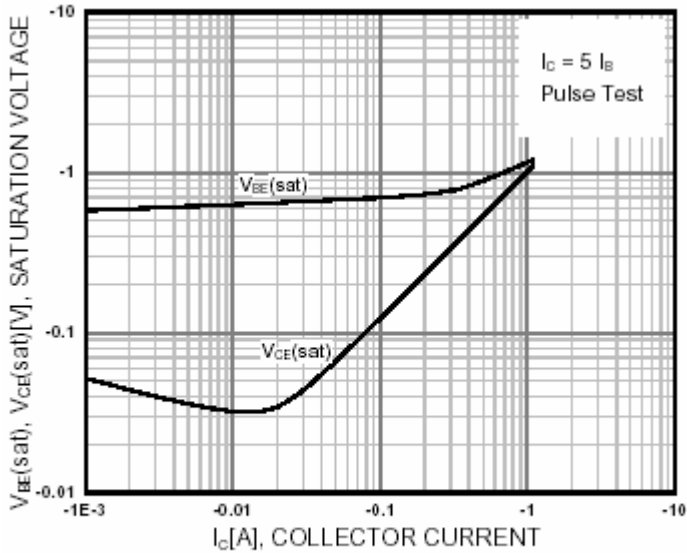

Fig.5 Base-Emitter Saturation Voltage  
Collector-Emitter Saturation Voltage

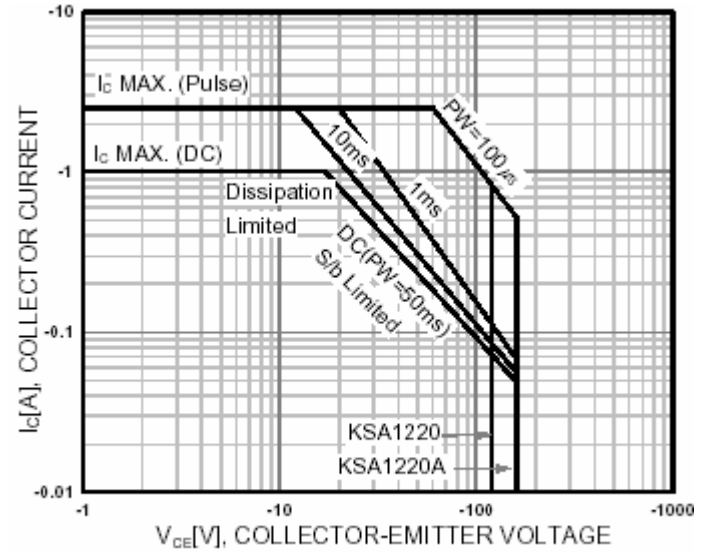

Fig.6 Safe Operating Area

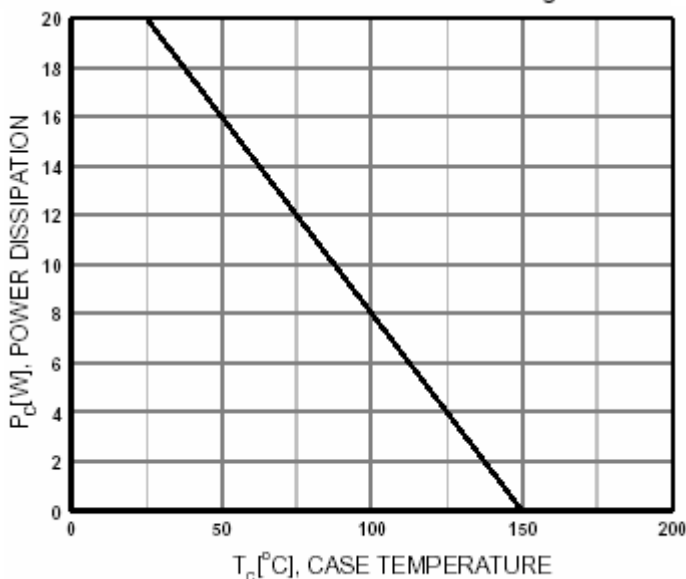

Fig.7 Power Derating