

PLEASE CHECK WWW.MOLEX.COM FOR LATEST PART INFORMATION

Part Number: **0674901230**
Status: **Active**
Overview: [serial_ata_products](#)
Description: 1.27mm (.050") Pitch Serial ATA Header, Standard Type, Surface Mount, Right Angle, 7 Circuits, with Mylar, Gold (Au) Flash, Embossed Tape on Reel Package, Lead-free

Documents:

[3D Model](#) [Product Specification PS-67490-001 \(PDF\)](#)
[Drawing \(PDF\)](#) [RoHS Certificate of Compliance \(PDF\)](#)

General

Product Family	PCB Headers
Series	67490
Application	Board-to-Board, Wire-to-Board
Comments	Standard Type With Mylar
Overview	serial_ata_products
Product Name	Serial ATA

Physical

Breakaway	No
Circuits (Loaded)	7
Circuits (maximum)	7
Color - Resin	Black
Durability (mating cycles max)	50
First Mate / Last Break	Yes
Glow-Wire Compliant	No
Guide to Mating Part	Yes
Keying to Mating Part	Yes
Lock to Mating Part	No
Material - Plating Mating	Gold
Material - Plating Termination	Tin
Material - Resin	High Temperature Thermoplastic
Number of Rows	1
Orientation	Right Angle
PCB Locator	No
PCB Retention	Yes
PCB Thickness Recommended (in)	0.062 In
PCB Thickness Recommended (mm)	1.60 mm
Packaging Type	Embossed Tape on Reel
Pitch - Mating Interface (in)	0.050 In
Pitch - Mating Interface (mm)	1.27 mm
Pitch - Term. Interface (in)	0.050 In
Pitch - Term. Interface (mm)	1.27 mm
Plating min: Mating (µin)	2
Plating min: Mating (µm)	0.05
Plating min: Termination (µin)	50.8
Plating min: Termination (µm)	1.27
Polarized to Mating Part	No
Shrouded	No
Stackable	No
Temperature Range - Operating	-35°C to +85°C
Termination Interface: Style	Surface Mount

Electrical

Current - Maximum per Contact	1.5A
Voltage - Maximum	15V DC

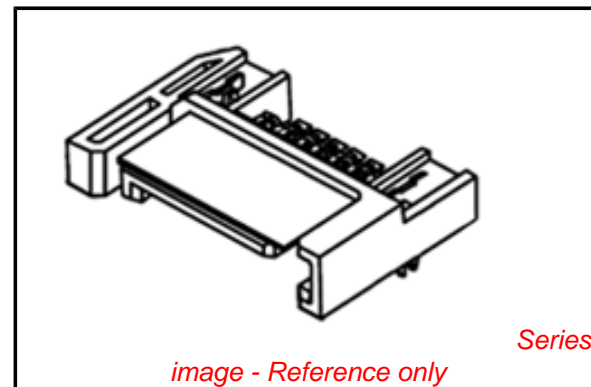

EU RoHS

ELV and RoHS Compliant
REACH SVHC
 Not Reviewed
Halogen-Free Status

China RoHS



Not Reviewed

Need more information on product environmental compliance?

Email productcompliance@molex.com
 For a multiple part number RoHS Certificate of Compliance, [click here](#)

Please visit the [Contact Us](#) section for any non-product compliance questions.

Search Parts in this Series

[67490Series](#)

Mates With

Serial ATA Signal Connector [67489](#) , [88755](#)

Material Info

Reference - Drawing Numbers

Packaging Specification	PK-67490-000
Product Specification	PS-67490-001
Sales Drawing	SD-67490-002

This document was generated on 05/25/2010

PLEASE CHECK WWW.MOLEX.COM FOR LATEST PART INFORMATION

P/N	CONTACT AREA PLATEING	PACKAGE METHOD	REMARK
67490-1220	GOLD FLASH	WITHOUT MYLAR	PURE TIN
67490-1221	0.76 MICRONS GOLD PLATED	TRAY PACKAGE	
67490-1225	0.38 MICRONS GOLD PLATED	PK-67490-001	
67490-1230	GOLD FLASH	WITH MYLAR	
67490-1231	0.76 MICRONS GOLD PLATED	TAPE REEL	
67490-1235	0.38 MICRONS GOLD PLATED	PK-67490-000	
67490-1240	GOLD FLASH	WITH MYLAR	
67490-1241	0.76 MICRONS GOLD PLATED	TUBE PACKAGE	
67490-1245	0.38 MICRONS GOLD PLATED	PK-67490-002	

▽

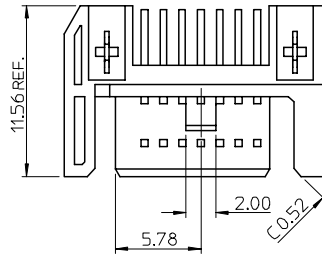

NOTES:

- MATERIAL:
HOUSING: HIGH TEMPERATURE THERMAL PLASTIC
GLASS FILLED, UL94V-0, COLOR: BLACK
TERMINAL/FORKLOCK: COPPER ALLOY
MYLAR: ADHENSIVE MYLAR 4.5MM X 15.5MM
- TERMINAL PLATING:
CONTACT AREA: GOLD PLATED
SOLDERING TAIL: 1.27 MICRONS MINIMUM TIN PLATED
UNDER PLATE: NICKEL 1.27 MICRONS MINIMUM NICKEL PLATED
- FORKLOCK PLATING:
1.27 MICRONS MINIMUM TIN PLATED OVERALL 1.27 MICRONS MINIMUM NICKEL UNDER-PLATED
- PACKAGING SPECIFICATION REFER TO TABLE
- PRODUCT SPECIFICATION REFER TO PS-67490-001
- MATING PART: 67538, 67489

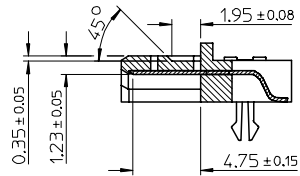

SECTION B-B
SCALE 3:1

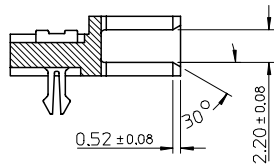

SECTION A-A
SCALE 3:1

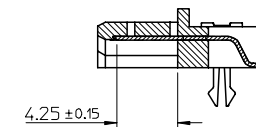
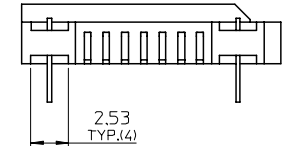
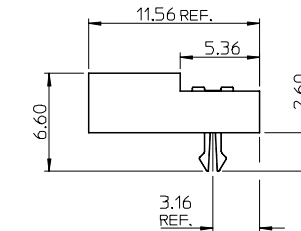
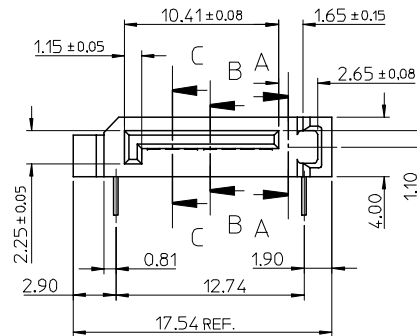

SECTION C-C
SCALE 3:1

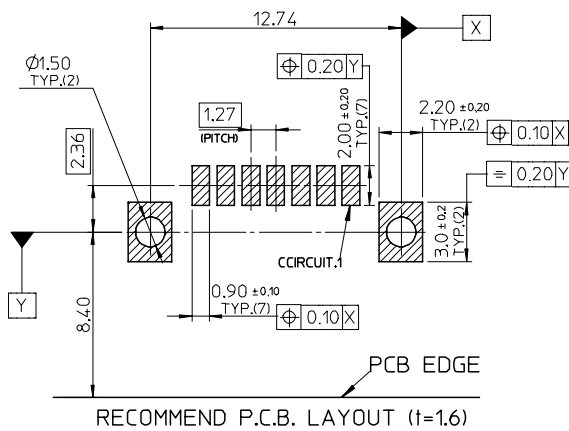
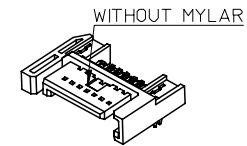
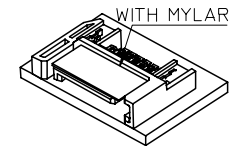

OBsolesce PART
EC NO: SH2006-0566
DRWN: BCHENZ6 2006/05/29
CHKD: GRATE MA 2006/05/29
APPR: INCHEV 2006/05/30

QUALITY SYMBOLS	DESCRIPTION
▽=0	
▽=0	

GENERAL TOLERANCES (UNLESS SPECIFIED)	
mm	INCH
4 PLACES ± ---	± ---
3 PLACES ± ---	± ---
2 PLACES ± 0.15	± ---
1 PLACE ± 0.25	± ---
ANGULAR ± 3 °	

DIMENSION STYLE	
MM ONLY	
DRAWN BY	DATE
RICHARD	'01/08/08
CHECKED BY	DATE
VINCENT	'01/08/08
APPROVED BY	DATE
ERICK	'01/08/08
MATERIAL NO.	DOCUMENT NO.
SEE TABLE	SD-67490-002

SCALE	DESIGN UNITS	THIRD ANGLE PROJECTION
4:1	METRIC	◎ ▽
SATA SYSTEM PLUG R/A STANDARD TYPE		
MOLEX INCORPORATED		
SIZE	SHEET NO.	
A3	1 OF 1	