

General Description

This Trench MOSFET has better characteristics, such as fast switching time, low on resistance, low gate charge and excellent avalanche characteristics. It is mainly suitable for Back-light Inverter and Power Supply.

FEATURES

- $V_{DSS}=40V$, $I_D=54A$.
- Low Drain-Source ON Resistance.
 - : $R_{DS(ON)}=8.5m\ \Omega$ (Max.) @ $V_{GS}=10V$
 - : $R_{DS(ON)}=11m\ \Omega$ (Max.) @ $V_{GS}=4.5V$
- Super High Dense Cell Design.
- High Power and Current Handling Capability.

MAXIMUM RATING (Ta=25 °C Unless otherwise Noted)

CHARACTERISTIC		SYMBOL	N-Ch	UNIT
Drain-Source Voltage		V_{DSS}	40	V
Gate-Source Voltage		V_{GSS}	± 20	V
Drain Current	DC@ $T_C=25\ ^\circ C$ (Note1)	I_D	54	A
	Pulsed (Note2)	I_{DP}	100	
Drain-Source-Diode Forward Current		I_S	100	A
Drain Power Dissipation	@ $T_C=25\ ^\circ C$ (Note1)	P_D	45	W
	@ $T_a=25\ ^\circ C$ (Note2)		3.1	
Maximum Junction Temperature		T_j	150	$^\circ C$
Storage Temperature Range		T_{stg}	-55 ~ 150	$^\circ C$
Thermal Resistance, Junction to Case (Note1)		R_{thJC}	2.8	$^\circ C/W$
Thermal Resistance, Junction to Ambient (Note2)		R_{thJA}	40	$^\circ C/W$

Note 1) R_{thJC} means that the infinite heat sink is mounted.

Note 2) Surface Mounted on 1" × 1" Pad of 2 oz copper.

PIN CONNECTION (TOP VIEW)

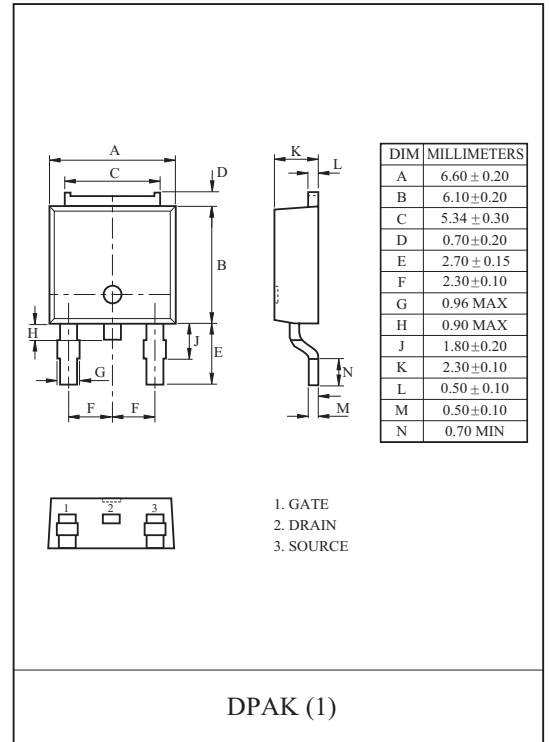
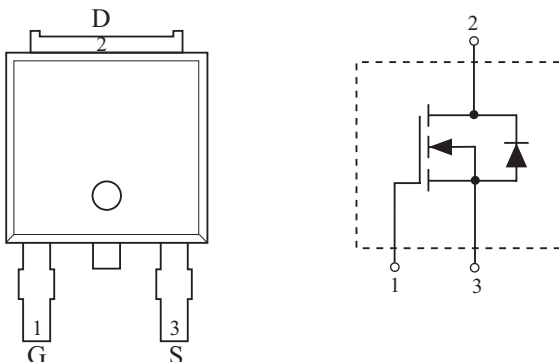

Marking

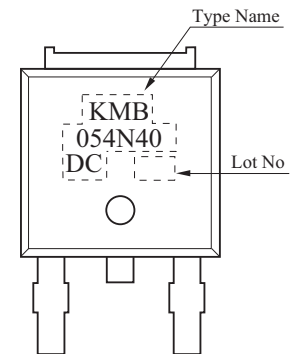

KMB054N40DC

ELECTRICAL CHARACTERISTICS (Ta=25 °C)

CHARACTERISTIC	SYMBOL	TEST CONDITION	MIN.	TYP.	MAX.	UNIT		
Static								
Drain-Source Breakdown Voltage	BV_{DSS}	$V_{GS}=0V, I_D=250\mu A$	40	-	-	V		
Drain Cut-off Current	I_{DSS}	$V_{GS}=0V, V_{DS}=32V$	-	-	1	μA		
Gate Leakage Current	I_{GSS}	$V_{GS}=\pm 20V, V_{DS}=0V$	-	-	± 100	nA		
Gate Threshold Voltage	V_{th}	$V_{DS}=V_{GS}, I_D=250\mu A$	1.7	-	2.6	V		
Drain-Source ON Resistance	$R_{DS(ON)*}$	$V_{GS}=10V, I_D=14A$	-	6.5	8.5	m Ω		
		$V_{GS}=4.5V, I_D=11A$	-	8.5	11			
		$V_{GS}=10V, I_D=14A, T_j=125^\circ C$	-	10.4	14			
Forward Transconductance	g_{fs*}	$V_{DS}=10V, I_D=20A$	-	58	-	S		
Dynamic								
Input Capacitance	C_{iss}	$V_{DS}=20V, f=1MHz, V_{GS}=0V$	-	1280	-	pF		
Output Capacitance	C_{oss}		-	250	-			
Reverse Transfer Capacitance	C_{rss}		-	125	-			
Total Gate Charge	$V_{GS}=10V$	$V_{DS}=20V, V_{GS}=10V, I_D=14A$	-	25.4	-	nC		
	$V_{GS}=5V$		-	13.8	-			
Gate-Source Charge	Q_{gs}^*		-	5.7	-			
Gate-Drain Charge	Q_{gd}^*		-	5.4	-			
Turn-On Delay Time	$t_{d(on)}^*$		$V_{DD}=20V, V_{GS}=10V$ $I_D=1A, R_G=6\Omega$	-	19		-	ns
Turn-On Rise Time	t_r^*			-	16		-	
Turn-Off Delay Time	$t_{d(off)}^*$	-		60	-			
Turn-Off Fall Time	t_f^*	-		14	-			
Source-Drain Diode Ratings								
Source-Drain Forward Voltage	V_{SDF}^*	$V_{GS}=0V, I_S=14A$	-	0.8	1.2	V		
Note>* Pulse Test : Pulse width <300 μs , Duty cycle < 2%								

Fig1. $I_D - V_{DS}$

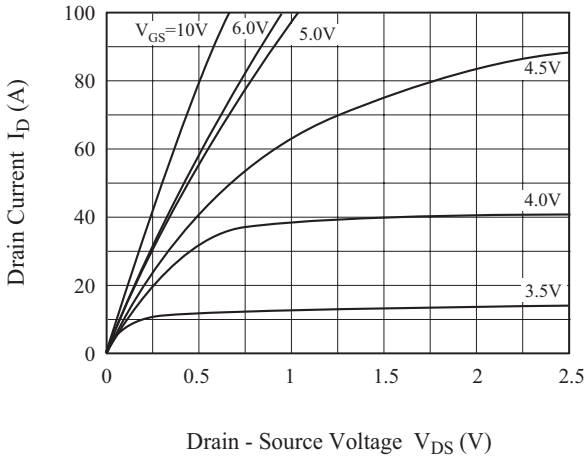

Fig2. $R_{DS(ON)} - I_D$

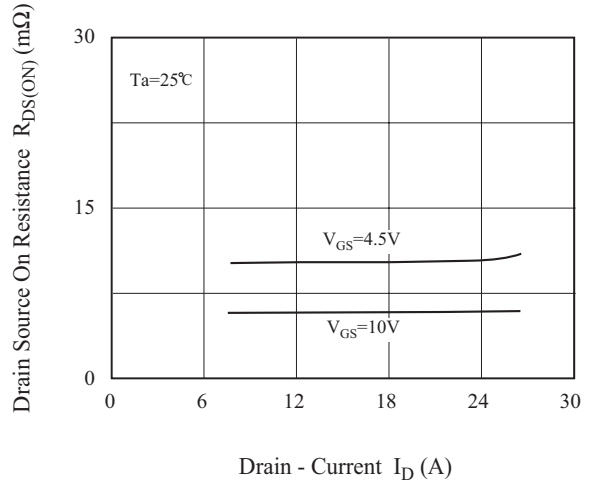

Fig3. $I_D - V_{GS}$

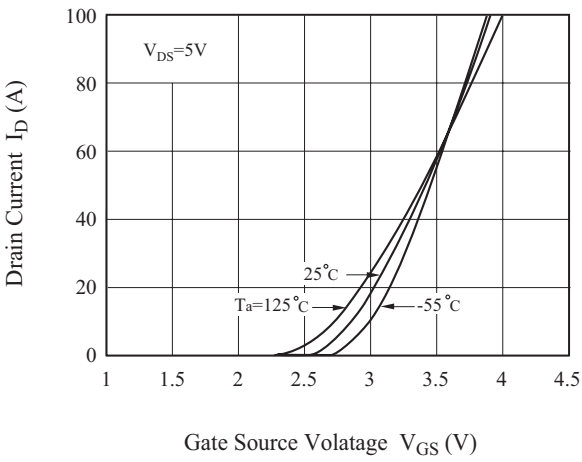

Fig4. $R_{DS(on)} - T_j$

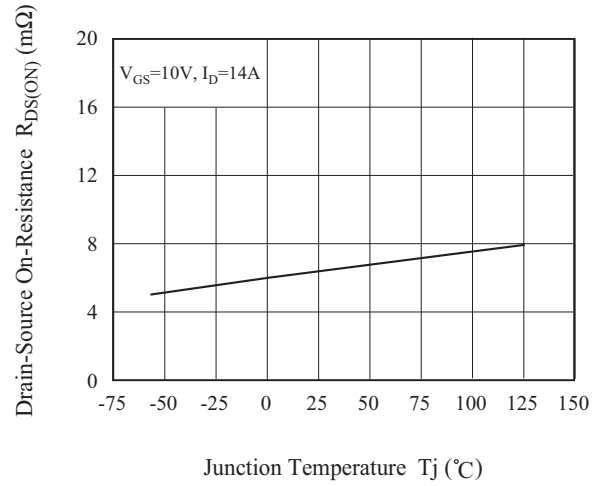

Fig5. $V_{th} - T_j$

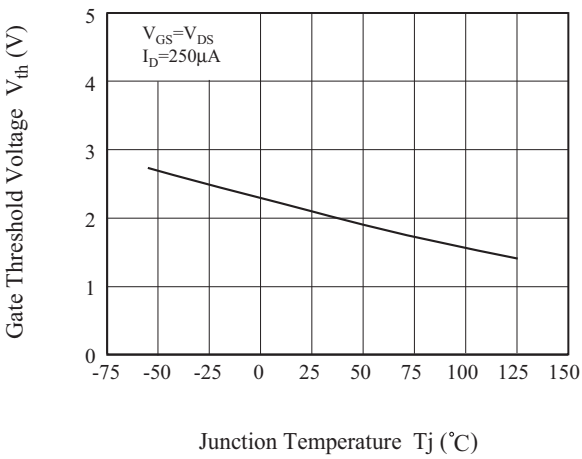
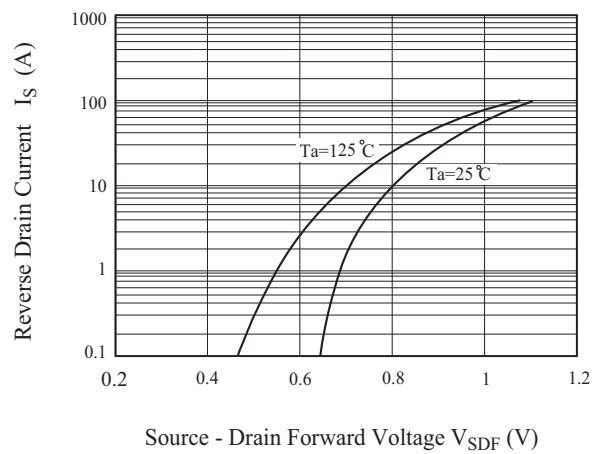

Fig6. $I_S - V_{SDF}$



KMB054N40DC

Fig 7. $V_{GS} - Q_g$

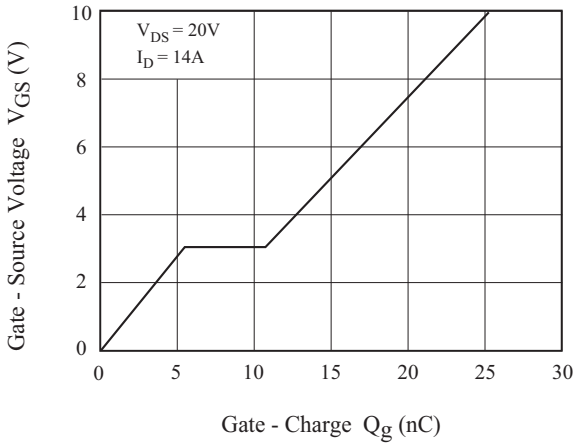

Fig 8. $C - V_{DS}$

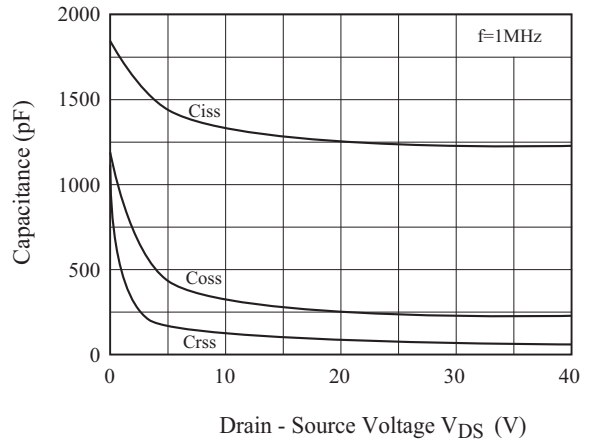

Fig9. Safe Operation Area

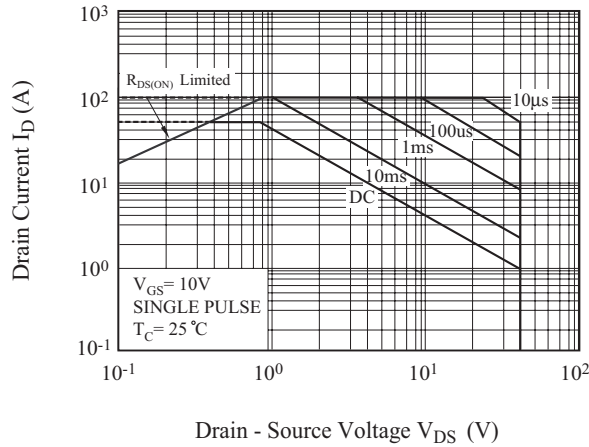

Fig10. Transient Thermal Response Curve

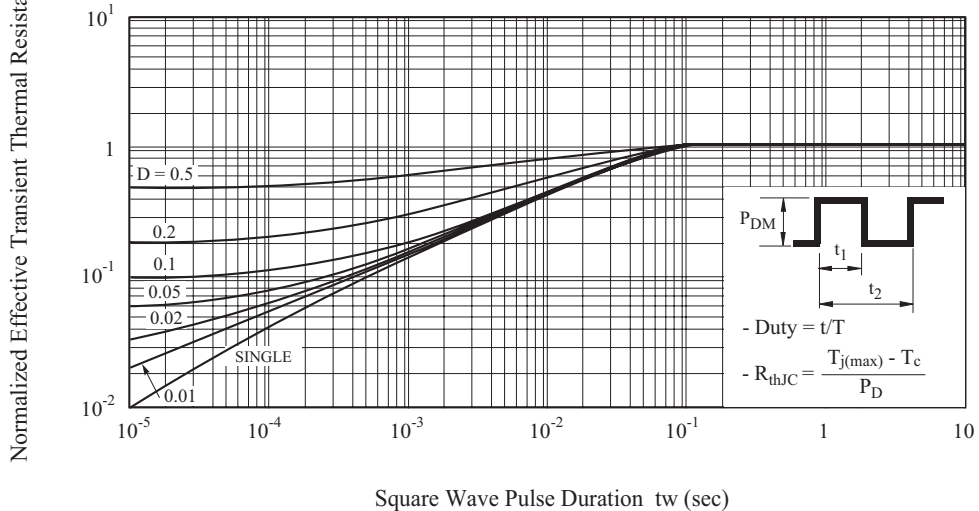

Fig11. Gate Charge Circuit and Wave Form

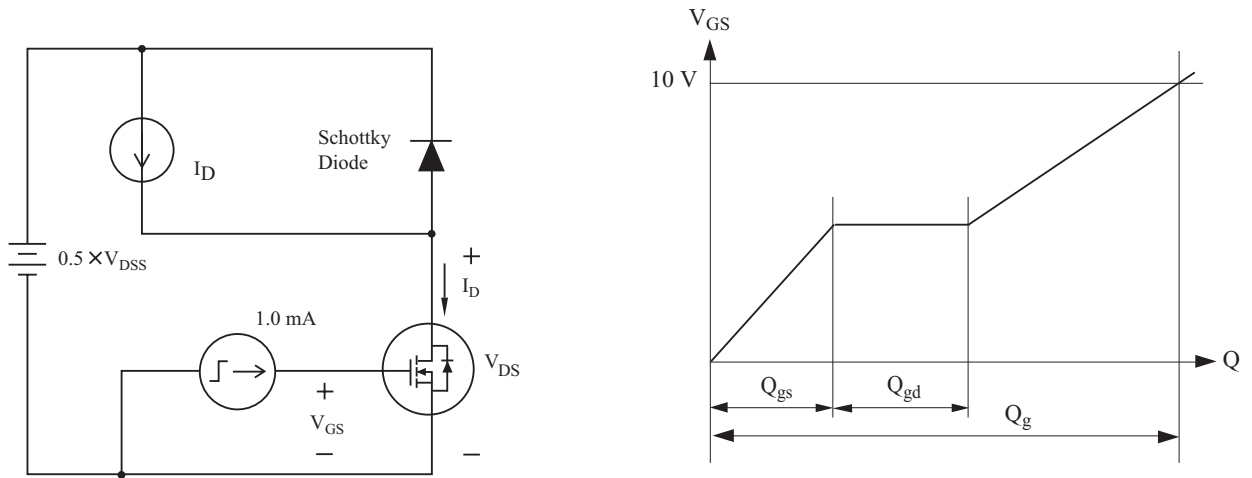

Fig12. Resistive Load Switching

