



2SB776

PNP PLANAR TRANSISTOR

MEDIUM POWER LOW VOLTAGE TRANSISTOR

DESCRIPTION

The UTC 2SB776 is a medium power low voltage transistor, designed for audio power amplifier, DC-DC converter and voltage regulator.

FEATURES

- * High Current Output Up to 3A
- * Low Saturation Voltage
- * Complement to 2SD886

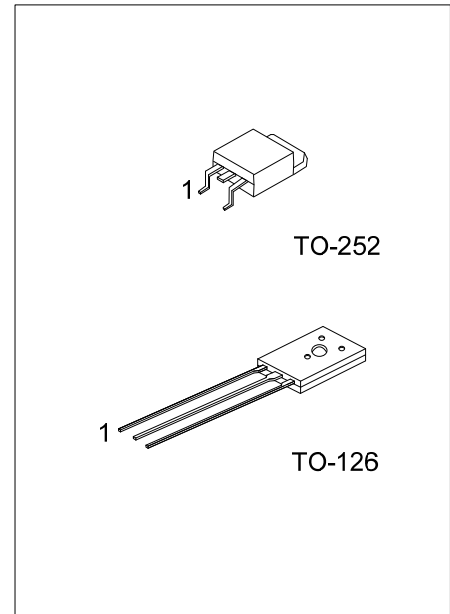

ORDERING INFORMATION

Ordering Number			Package	Pin Assignment			Packing
Normal	Lead Free Plating	Halogen Free		1	2	3	
2SB776-x-T60-K	2SB776L-x-T60-K	2SB776G-x-T60-K	TO-126	E	C	B	Bulk
2SB776-x-TN3-R	2SB776L-x-TN3-R	2SB776G-x-TN3-R	TO-252	B	C	E	Tape Reel

<p>2SB776G-x-T60-K</p>	<p>(1) Packing Type (2) Package Type (3) Rank (4) Halogen Free</p> <p>(1) K: Bulk, R: Tape Reel (2) T60: TO-126, TN3: TO-252 (3) x: refer to Classification of h_{FE2} (4) G: Halogen Free, L: Lead Free Plating Blank: Pb/Sn</p>
------------------------	--

■ ABSOLUTE MAXIMUM RATINGS (Ta=25°C ,unless otherwise specified)

PARAMETER	SYMBOL	RATINGS	UNIT
Collector-Base Voltage	V_{CBO}	-50	V
Collector-Emitter Voltage	V_{CEO}	-50	V
Emitter-Base Voltage	V_{EBO}	-5	V
Collector Current	DC	-3	A
	PULSE	-7	A
Base Current	I_B	-0.6	A
Collector Dissipation (T _C =25°C)	TO-126	10	W
	TO-252	25	W
Junction Temperature	T_J	+150	°C
Storage Temperature	T_{STG}	-55 ~ +150	°C

Note: Absolute maximum ratings are those values beyond which the device could be permanently damaged. Absolute maximum ratings are stress ratings only and functional device operation is not implied.

■ ELECTRICAL CHARACTERISTICS (Ta=25°C, unless otherwise specified)

PARAMETER	SYMBOL	TEST CONDITIONS	MIN	TYP	MAX	UNIT
Collector Cut-Off Current	I_{CBO}	$V_{CB}=-50V, I_E=0$			-1000	nA
Emitter Cut-Off Current	I_{EBO}	$V_{EB}=-3V, I_C=0$			-1000	nA
DC Current Gain (Note)	h_{FE1}	$V_{CE}=-2V, I_C=-20mA$	100	200		
	h_{FE2}	$V_{CE}=-2V, I_C=-1A$	100	150	400	
Collector-Emitter Saturation Voltage	$V_{CE(SAT)}$	$I_C=-2A, I_B=-0.2A$		-0.3	-0.5	V
Base-Emitter Saturation Voltage	$V_{BE(SAT)}$	$I_C=-2A, I_B=-0.2A$		-1.0	-2.0	V
Current Gain Bandwidth Product	f_T	$V_{CE}=-5V, I_C=-0.1A$		80		MHz
Output Capacitance	C_{ob}	$V_{CB}=-10V, I_E=0, f=1MHz$		45		pF

Note: Pulse test: PW<300μs, Duty Cycle<2%

■ CLASSIFICATION OF h_{FE2}

RANK	Q	P	E
RANGE	100-200	160-320	200-400

TYPICAL CHARACTERISTICS

Static Characteristics

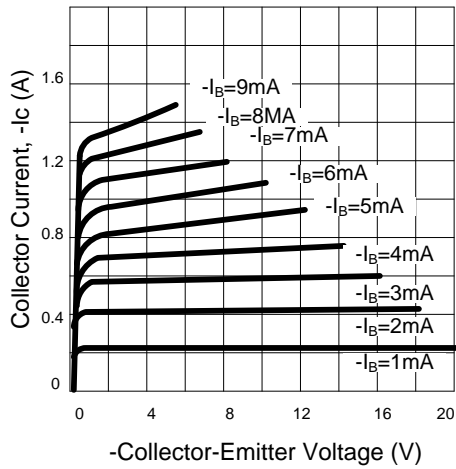

Derating Curve of Safe Operating Areas

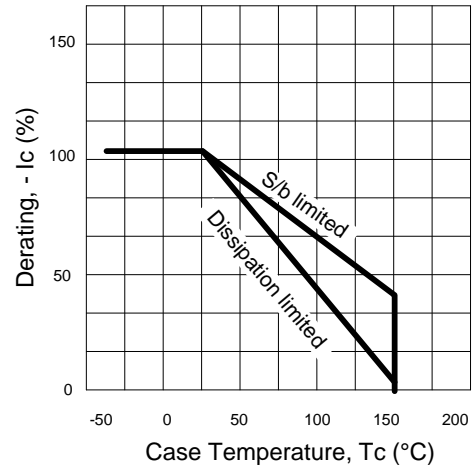

Current Gain-Bandwidth Product

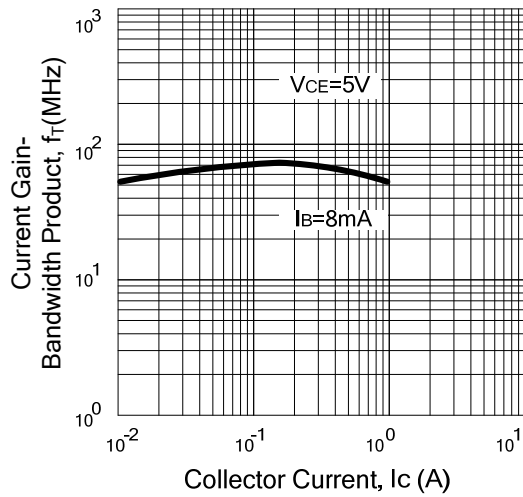

Safe Operating Area

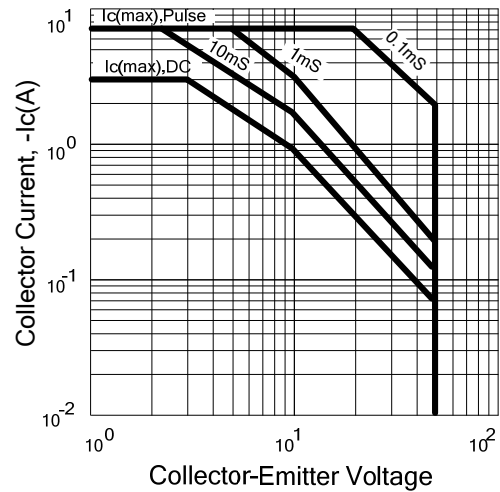

DC Current Gain

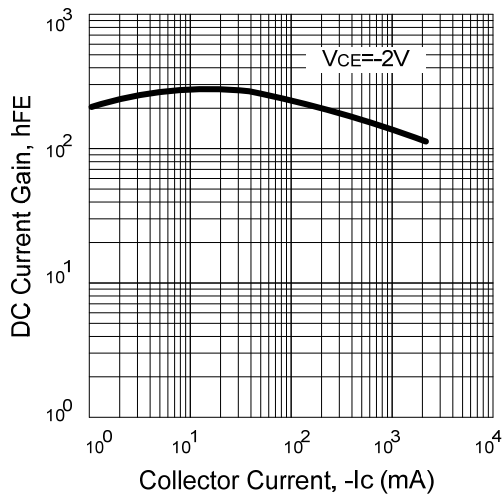

Saturation Voltage

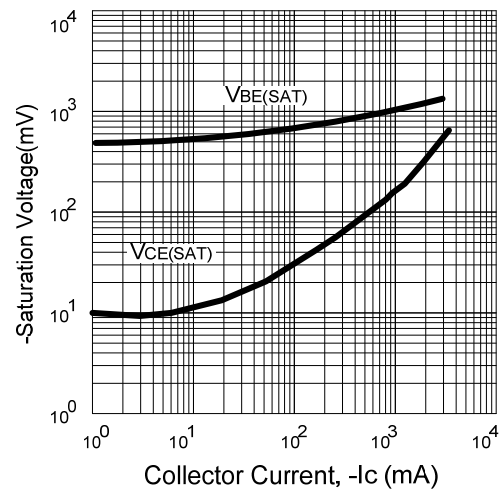

■ TYPICAL CHARACTERISTICS(Cont.)

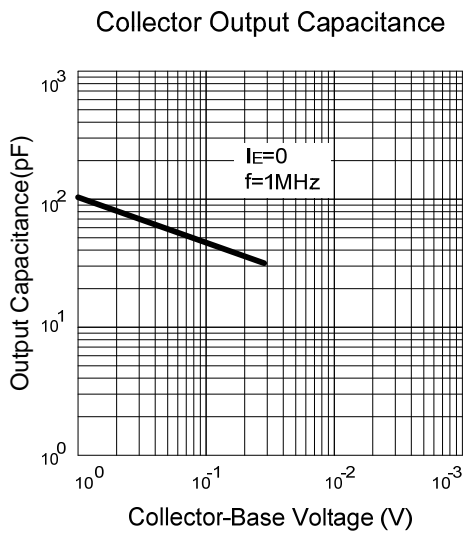

UTC assumes no responsibility for equipment failures that result from using products at values that exceed, even momentarily, rated values (such as maximum ratings, operating condition ranges, or other parameters) listed in products specifications of any and all UTC products described or contained herein. UTC products are not designed for use in life support appliances, devices or systems where malfunction of these products can be reasonably expected to result in personal injury. Reproduction in whole or in part is prohibited without the prior written consent of the copyright owner. The information presented in this document does not form part of any quotation or contract, is believed to be accurate and reliable and may be changed without notice.