

UTC U584/57 LINEAR INTEGRATED CIRCUIT

8A,5A,3A LOW DROPOUT POSITIVE REGULATORS ADJUSTABLE AND FIXED

DESCRIPTION

The UTC U584/585/587 voltage regulators are monolithic integrated circuits, designed for use in applications requiring a well regulated positive output voltage with +5V input. The output voltage can be adjustable from 3.8 V down to 1.3V.

www.DataSheet4U.com

FEATURES

- *Low dropout performance.
- *Adjustable output down to 1.3V.
- *Line regulation typically below 0.1%.
- *Load regulation typically below 0.1%.
- *Output current can be up to 8 A for UTC U584.
- *Three-terminal adjustable or fixed 3.3V.

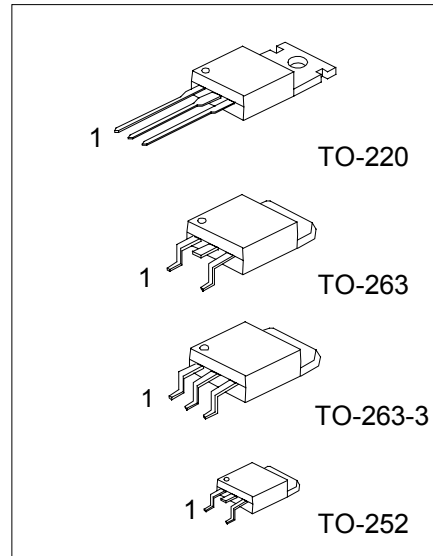

1: ADJ/GND 2: OUTPUT 3: INPUT

BLOCK DIAGRAM

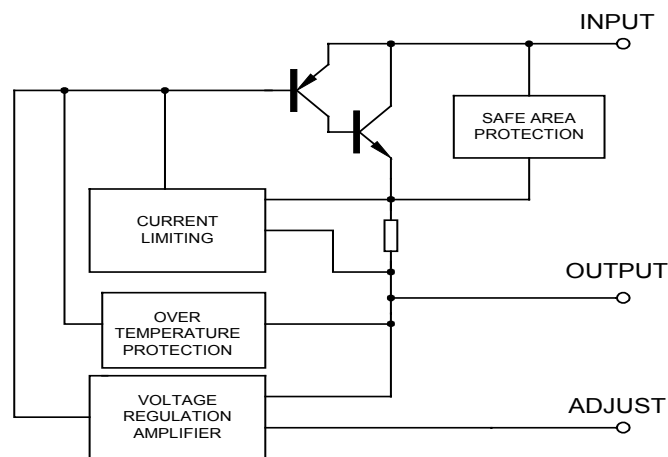

UTC UNISONIC TECHNOLOGIES CO., LTD. 1

QW-R102-003,E

UTC U584/57 LINEAR INTEGRATED CIRCUIT

ABSOLUTE MAXIMUM RATINGS

PARAMETER	SYMBOL	VALUE	UNIT
Input Voltage	V _{IN}	7	V
Power Dissipation	P _D	Internally Limited	W
Operating Junction Temperature Range	T _J	0 to 125	°C
Storage Temperature	T _{STG}	-65 to 150	°C
Lead Temperature (Soldering 10 Sec.)	T _{LEAD}	300	°C

www.DataSheet4U.com

ELECTRICAL CHARACTERISTICS

PARAMETER	TEST CONDITIONS	MIN	TYP	MAX	UNIT
Reference Voltage U584 U585 U587	1.3V ≤ (V _{IN} -V _{OUT}) ≤ 3V, 10mA ≤ I _{OUT} ≤ 8A 1.3V ≤ (V _{IN} -V _{OUT}) ≤ 3V, 10mA ≤ I _{OUT} ≤ 5A, 1.3V ≤ (V _{IN} -V _{OUT}) ≤ 3V, 10mA ≤ I _{OUT} ≤ 3A	* 1.225	1.25	1.275	V
Output Voltage U584-3.3 U585-3.3 U587-3.3	4.75V ≤ V _{IN} ≤ 6.5V, 10mA ≤ I _{OUT} ≤ 8A 4.75V ≤ V _{IN} ≤ 7V, 10mA ≤ I _{OUT} ≤ 5A 4.75V ≤ V _{IN} ≤ 7V, 10mA ≤ I _{OUT} ≤ 3A	3.234	3.300	3.366	V
Line Regulation (Note 1.2) U584/5/7 U584/5/7-3.3	2.75V ≤ V _{IN} ≤ 7V, I _{OUT} = 10mA 4.75V ≤ V _{IN} ≤ 7V, I _{OUT} = 0mA		0.1	0.2	%
Load Regulation (Note 1, 2, 3) U584/5/7 U584/5/7-3.3	V _{IN} -V _{OUT} = 2.5V, T _j = 25°C, 10mA ≤ I _{OUT} ≤ I _{FULLLOAD} V _{IN} = 5V, T _j = 25°C, 0mA ≤ I _{OUT} ≤ I _{FULLLOAD}	*	0.2	1.0	%
Dropout Voltage	ΔV _{REF} = 1%, I _{OUT} = I _{FULLLOAD} T _j ≥ 25°C T _j ≤ 25°C		1.2 1.2	1.3 1.35	V V
Current Limit (Note 3) U584 U585 U587	V _{IN} -V _{OUT} = 3V V _{IN} -V _{OUT} = 3V V _{IN} -V _{OUT} = 3V	* 8.0 5.0 3.0	8.5 5.5 3.6		A
Adjust Pin Current			55	120	μA
Adjust Pin Current Change (Note 3)	1.5V ≤ (V _{IN} -V _{OUT}) ≤ 3V, 10mA ≤ I _{OUT} ≤ I _{FULLLOAD}		0.2	5	mA
Minimum Load Current	1.5V ≤ (V _{IN} -V _{OUT}) ≤ 3V	*	2	10	mA
Quiescent Circuit Current	V _{IN} ≤ 5V	*	8	13	mA
Ripple Rejection	f = 120Hz, C _{OUT} = 25μA _{Tant} , V _{IN} -V _{OUT} = 2.5V, I _{OUT} = I _{FULLLOAD}	60	72		dB
Temperature Stability			0.5		%
Long-Term Stability	T _A = 25°C, 1000Hrs		0.03	1.0	%
RMS Output Noise (% of V _{OUT})	T _A = 125°C, 10Hz ≤ f ≤ 10kHz		0.03		%
Thermal Resistance Junction to Case U584 U587				1.6 3.0	°C/W
Thermal Resistance Junction to Ambient, θ _{JA} U585				60	°C/W
Thermal Resistance Junction to Board, θ _{JT} U585				2.7	°C/W

UTC UNISONIC TECHNOLOGIES CO., LTD. 2

QW-R102-003,E

UTC U584/5/7 LINEAR INTEGRATED CIRCUIT

The * denotes specifications which apply over the specified operating temperature range.

Note 1: Load and line regulation are measured at a constant junction temperature by low duty cycle pulse testing.

Note 2: Line and load regulation are guaranteed up to the maximum power dissipation (15W for the UTC U584, 10W for the UTC U585). Power dissipation is determined by input / output differential and the output current. Guaranteed maximum output power will not be available over the full input-output voltage range.

Note 3: I_{FULLLOAD} is defined as the maximum value of output load current as a function of input-to-output voltage. Output current can be different for different input-to-output voltage.

APPLICATION CIRCUIT (ADJUSTABLE)

www.DataSheet4U.com

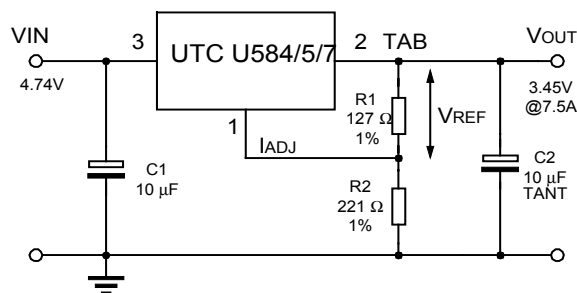

REQUIRED FOR STABILITY

$$V_{OUT} = V_{REF} \cdot (1 + R2/R1) + I_{ADJ} \cdot R2$$

APPLICATION CIRCUIT (3.3V)

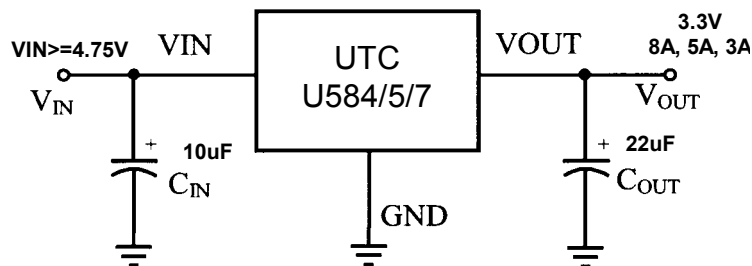

UTC U584/57 LINEAR INTEGRATED CIRCUIT

TYPICAL PERFORMANCE CHARACTERISTICS

U584

Dropout Voltage

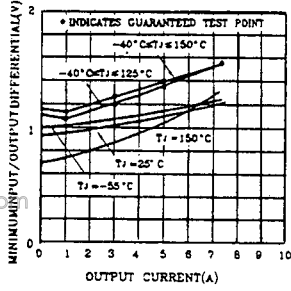

U584

Short-Circuit Current

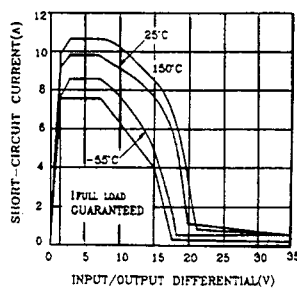

U584

Load Regulation

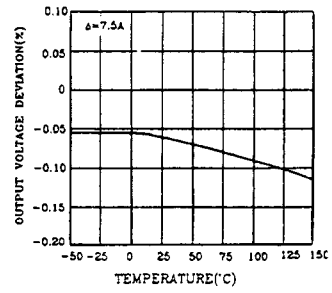

U585

Dropout Voltage

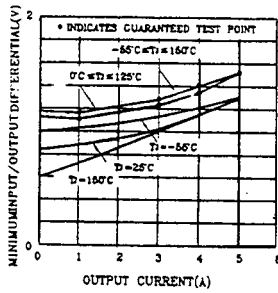

U585

Short-Circuit Current

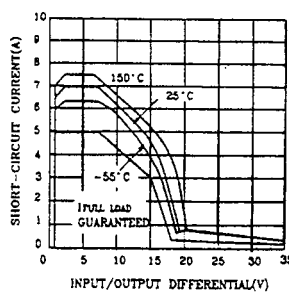

U585

Load Regulation

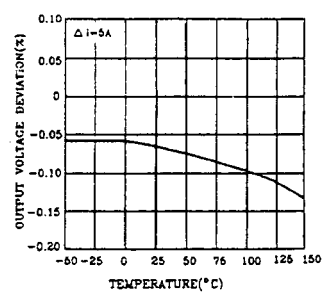

U587

Dropout Voltage

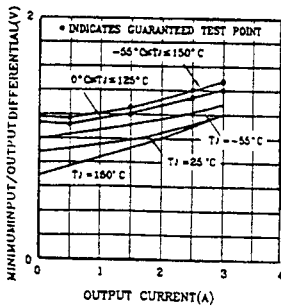

U587

Short-Circuit Current

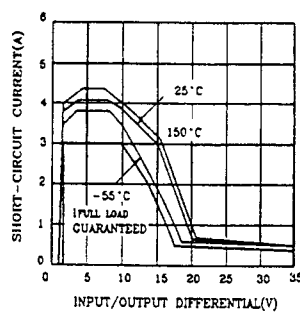

U587

Load Regulation

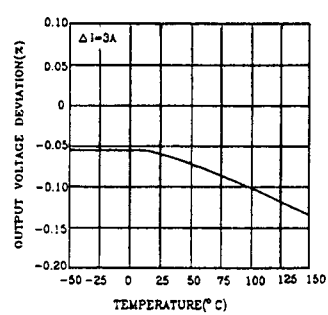

UTC U584/57 LINEAR INTEGRATED CIRCUIT

Minimum Operating Current

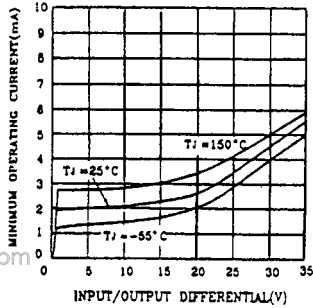

Temperature Stability

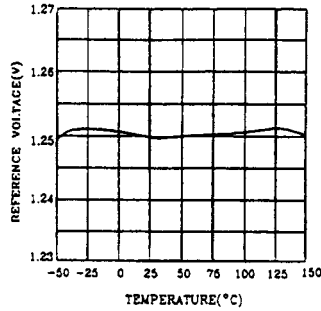

Adjust Pin Current

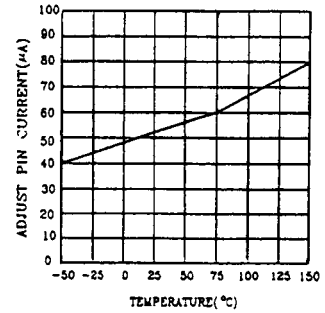

www.DataSheet4U.com

U584

Ripple Rejection

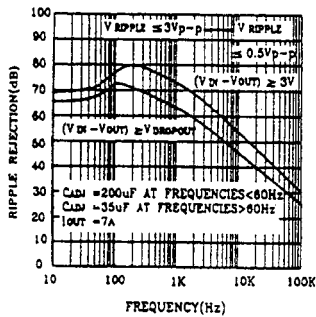

U584

Ripple Rejection vs Current

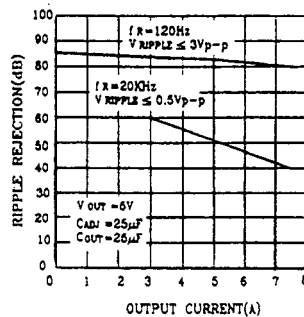

U584

Maximum Power Dissipation*

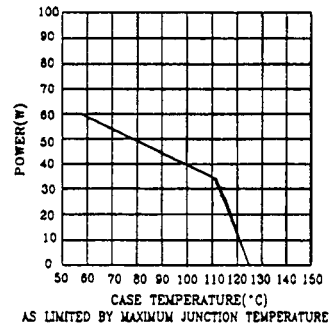

U585

Ripple Rejection

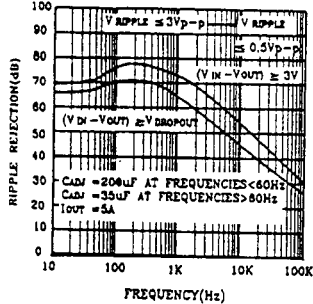

U585

Ripple Rejection vs Current

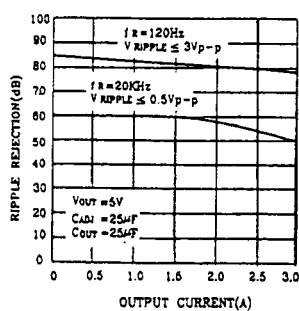

U585

Maximum Power Dissipation

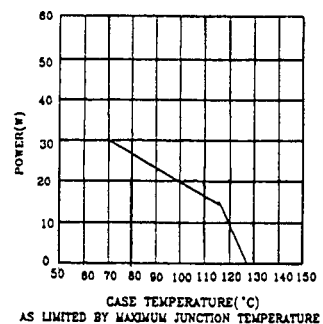

UTC U584/57 LINEAR INTEGRATED CIRCUIT

U587

Ripple Rejection

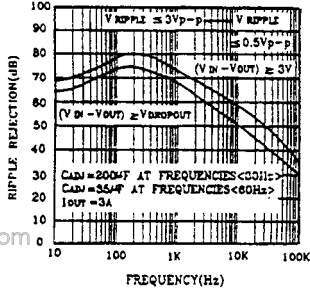

U587

Ripple Rejection vs Current

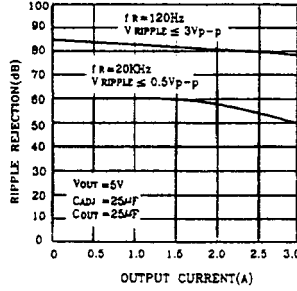

U587

Maximum Power Dissipation

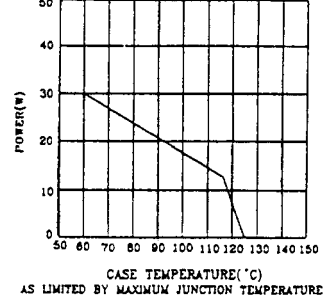

www.DataSheet4U.com

U584

Load Transient Response

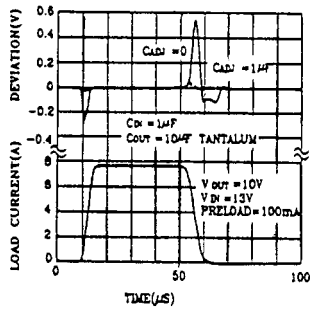

U585

Load Transient Response

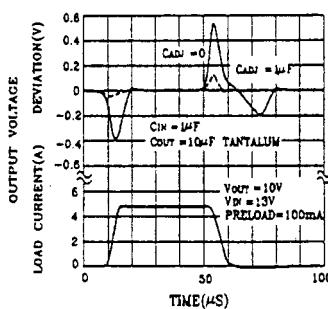

U587

Load Transient Response

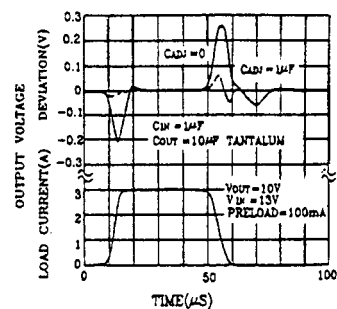

U584

Line Transient Response

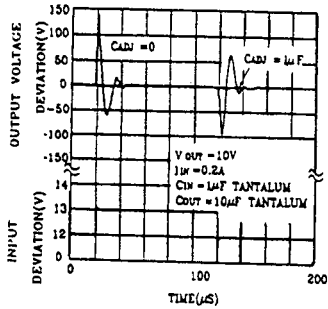

U585

Line Transient Response

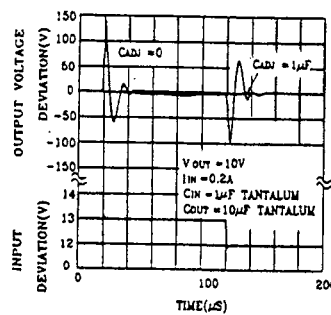

U587

Line Transient Response

