

Features

- Output voltages of 5.0V, 8.0V, 12V
- Output voltage tolerances of $\pm 5\%$ over the operating temperature ranges
- Output current in excess of 100mA
- Internal thermal overload protection
- Output transistor safe area protection
- Internal short circuit current limiting
- No external components
- Available in plastic TO92-3L, SOT89-3L and plastic SOP-8L low profile packages
- Lead Free Package: TO92-3L (Note 1)
- SOP-8L and SOT89-3L: Available in "Green" Molding Compound (No Br, Sb) (Note 2)
- Lead Free Finish / RoHS Compliant (Note 3)

General Description

The AP78LXX Series is a three terminal positive regulator available with fixed output voltages from 5V, 8V and 12V, making them useful in a wide range of applications. When used as a Zener diode/resistor combination replacement, the AP78LXX can improve output impedance by two orders of magnitude, and lower quiescent current. These regulators can provide local on card regulation, eliminating the distribution problems associated with single point regulation. The voltages available allow the AP78LXX's to be used in logic systems. Instrumentation, HiFi and other solid state electronic equipment.



The AP78LXX is available in the plastic TO92-3L, SOT89-3L and SOP-8L using industrial standard package technology. The regulator can deliver 100mA output current with adequate heat sinking. Current limiting is included to limit the peak output current to a safe value. Safe area protection for the output transistors is provided to limit internal power dissipation. Thermal overload protection is integrated to prevent the IC from overheat due to abnormal condition.

Applications

- Communication
- CD-ROM
- DVD-Player
- Set-Top Box

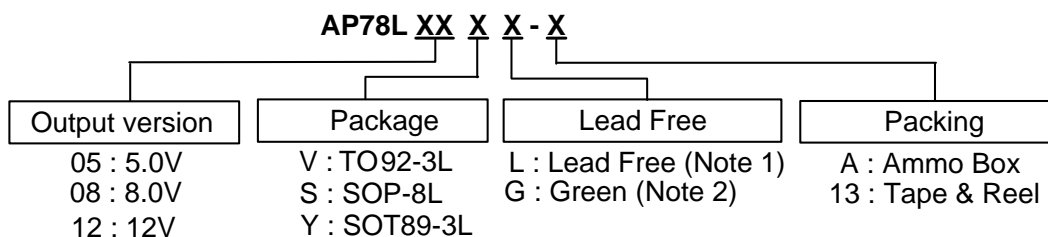
Ordering Information



Device	Package Code	Packaging (Note 4)	Ammo Box / Tube		13" Tape and Reel	
			Quantity	Part Number Suffix	Quantity	Part Number Suffix
 AP78LXXVL-A	V	TO92-3L	2000/Box	-A	NA	NA
 AP78LXXSG-13	S	SOP-8L	NA	NA	2500/Tape & Reel	-13
 AP78LXXYG-13	Y	SOT89-3L	NA	NA	2500/Tape & Reel	-13

- Notes:
1. TO92-3L is available in "Lead Free" product only.
 2. SOP-8L and SOT89-3L are available in "Green" products only.
 3. EU Directive 2002/95/EC (RoHS). All applicable RoHS exemptions applied. Please visit our website at http://www.diodes.com/products/lead_free.html.
 4. Pad layout as shown on Diodes Inc. suggested pad layout document AP02001, which can be found on our website at <http://www.diodes.com/datasheets/ap02001.pdf>.

Pin Assignments

(1) TO92-3L

(Bottom View)

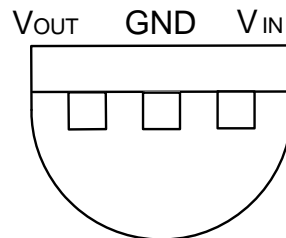

TO92-3L

(2) SOP-8L

(Top View)

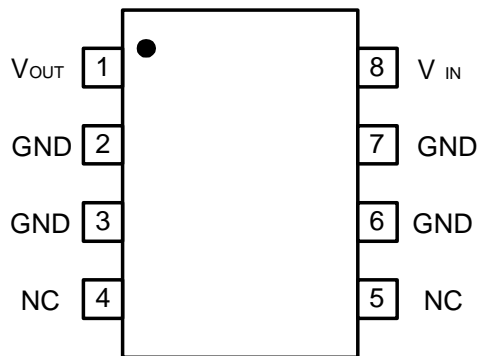

SOP-8L

(3) SOT89-3L

(Top View)

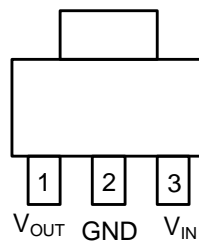

SOT89-3L

Pin Descriptions

Pin Name	Description
V _{IN}	Operating Voltage Input
V _{OUT}	Voltage Output Pin
GND	Ground
NC	No Connection

Absolute Maximum Ratings

Symbol	Parameter	Rating	Unit
ESD HBM	Human Body Model ESD Protection	3	KV
ESD MM	Machine Model ESD Protection	250	V
V _{CC}	Supply Voltage	+30	V
V _{OUT}	Output Voltage to Ground	AP78L05	5
		AP78L08	8
		AP78L12	12
T _{ST}	Storage Temperature	-65 to +150	°C
T _{OP}	Operating Junction Temperature	-20 to 125	°C
T _{MJ}	Maximum Junction Temperature	150	°C

Recommended Operating Conditions

Symbol	Parameter	Min	Max	Unit
V _{IN}	Input Voltage	AP78L05	7	20
		AP78L08	10.5	23
		AP78L12	14.5	27
I _{OUT}	Output Current	0	100	mA
T _A	Operating Ambient Temperature	-20	85	°C

AP78LXX Electrical Characteristics (All Output Voltage Versions)

Limits in standard typeface are for $T_A = 25^\circ\text{C}$, **Bold typeface applies over $T_J = -20^\circ\text{C}$ to 125°C for TO92-3L, SOT89-3L and SOP-8L Packages.** Unless otherwise specified: $I_O = 40\text{mA}$, $C_I = 0.33\mu\text{F}$, $C_O = 0.1\mu\text{F}$.

AP78L05

Unless otherwise specified, $V_{IN} = 10\text{V}$

Symbol	Parameter	Conditions	Min	Typ.	Max	Unit
V_O	Output Voltage		4.8	5	5.2	V
		$7\text{V} \leq V_{IN} \leq 20\text{V}$ $1\text{mA} \leq I_O \leq 40\text{mA}$	4.75		5.25	
		$1\text{mA} \leq I_O \leq 70\text{mA}$	4.75		5.25	
ΔV_O	Line Regulation	$7\text{V} \leq V_{IN} \leq 20\text{V}$		18	75	mV
		$8\text{V} \leq V_{IN} \leq 20\text{V}$		10	54	
ΔV_O	Load Regulation	$1\text{mA} \leq I_O \leq 100\text{mA}$		20	60	mV
		$1\text{mA} \leq I_O \leq 40\text{mA}$		5	30	
I_Q	Quiescent Current			3	5	mA
ΔI_Q	Quiescent Current Change	$8\text{V} \leq V_{IN} \leq 20\text{V}$			1.0	
		$1\text{mA} \leq I_O \leq 40\text{mA}$			0.1	
V_n	Output Noise Voltage	$f = 10\text{Hz to } 100\text{kHz}$ (Note 5)	-	40		μV
$\Delta V_{IN}/\Delta V_{OUT}$	Ripple Rejection	$f = 120\text{Hz}$ $8\text{V} \leq V_{IN} \leq 16\text{V}$	47	62		dB
I_{PK}	Peak Output Current			140		mA
$\Delta V_O/\Delta T$	Average Output Voltage Tempco	$I_O = 5\text{mA}$		-0.65		$\text{mV}/^\circ\text{C}$
$V_{IN}(\text{Min})$	Minimum Value of Input Voltage Required to Maintain Line Regulation			6.7	7	V
θ_{JA}	Thermal Resistance Junction to Ambient	TO92-3L (Note 6)		176		$^\circ\text{C}/\text{W}$
		SOP-8L (Note 7)		153		
		SOT89-3L (Note 8)		145		
θ_{JC}	Thermal Resistance Junction to Case	TO92-3L (Note 6)		33		
		SOP-8L (Note 7)		18		
		SOT89-3L (Note 8)		25		

AP78LXX Electrical Characteristics (Continued)
AP78L08

 Unless otherwise specified, $V_{IN} = 14V$

Symbol	Parameter	Conditions	Min	Typ.	Max	Unit
V_O	Output Voltage		7.7	8	8.3	V
		$10.5V \leq V_{IN} \leq 23V$ $1mA \leq I_O \leq 40mA$	7.6		8.4	
		$1mA \leq I_O \leq 70mA$	7.6		8.4	
ΔV_O	Line Regulation	$10.5V \leq V_{IN} \leq 23V$		42	175	mV
		$11V \leq V_{IN} \leq 23V$		36	125	
ΔV_O	Load Regulation	$1mA \leq I_O \leq 100mA$		18	80	mV
		$1mA \leq I_O \leq 40mA$		10	40	
I_Q	Quiescent Current			2	5.5	mA
ΔI_Q	Quiescent Current Change	$11V \leq V_{IN} \leq 23V$			1.5	
		$1mA \leq I_O \leq 40mA$			0.1	
V_n	Output Noise Voltage	$f = 10Hz$ to $100kHz$ (Note 5)	-	54		μV
$\Delta V_{IN}/\Delta V_{OUT}$	Ripple Rejection	$f = 120Hz$ $13V \leq V_{IN} \leq 23V$	37	46		dB
I_{PK}	Peak Output Current			140		mA
$\Delta V_O/\Delta T$	Average Output Voltage Tempco	$I_O = 5mA$		-0.8		mV/°C
$V_{IN(Min)}$	Minimum Value of Input Voltage Required to Maintain Line Regulation			9.7		V
θ_{JA}	Thermal Resistance Junction to Ambient	TO92-3L (Note 6)		176		°C/W
		SOP-8L (Note 7)		153		
		SOT89-3L (Note 8)		157		
θ_{JC}	Thermal Resistance Junction to case	TO92-3L (Note 6)		33		°C/W
		SOP-8L (Note 7)		18		
		SOT89-3L (Note 8)		33		

AP78LXX Electrical Characteristics (Continued)
AP78L12

 Unless otherwise specified, $V_{IN} = 19V$

Symbol	Parameter	Conditions	Min	Typ.	Max	Unit
V_O	Output Voltage		11.5	12	12.5	V
		$14.5V \leq V_{IN} \leq 27V$ $1mA \leq I_O \leq 40mA$	11.4		12.6	
		$1mA \leq I_O \leq 70mA$	11.4		12.6	
ΔV_O	Line Regulation	$14.5V \leq V_{IN} \leq 27V$		30	180	mV
		$16V \leq V_{IN} \leq 27V$		20	110	
ΔV_O	Load Regulation	$1mA \leq I_O \leq 100mA$		30	100	mV
		$1mA \leq I_O \leq 40mA$		10	50	
I_Q	Quiescent Current			3	5	mA
ΔI_Q	Quiescent Current Change	$16V \leq V_{IN} \leq 27V$ $1mA \leq I_O \leq 40mA$			1 0.1	
V_n	Output Noise Voltage			80		μV
$\Delta V_{IN}/\Delta V_{OUT}$	Ripple Rejection	$f = 120Hz$ $15V \leq V_{IN} \leq 25V$	40	54		dB
I_{PK}	Peak Output Current			140		mA
$\Delta V_O/\Delta T$	Average Output Voltage Tempco	$I_O = 5mA$		-1.0		mV/°C
$V_{IN}(Min)$	Minimum Value of Input Voltage Required to Maintain Line Regulation			13.7	14.5	V
θ_{JA}	Thermal Resistance Junction to Ambient	TO92-3L (Note 6)		176		°C/W
		SOP-8L (Note 7)		153		
		SOT89-3L (Note 8)		145		
θ_{JC}	Thermal Resistance Junction to case	TO92-3L (Note 6)		33		°C/W
		SOP-8L (Note 7)		18		
		SOT89-3L (Note 8)		25		

- Notes:
5. Recommend 0.01 μF minimum load capacitance at output to suppress high frequency noise.
 6. Test conditions for TO92-3L: No heat sink, no air flow.
 7. Test conditions for SOP-8L: Device mounted on 2oz copper, minimum recommended pad layout, FR-4 PCB.
 8. Test conditions for SOT89-3L: Device mounted on FR-4 substrate PC board, 2oz copper, with minimum recommended pad layout.

Typical Performance Characteristics

For AP78L05

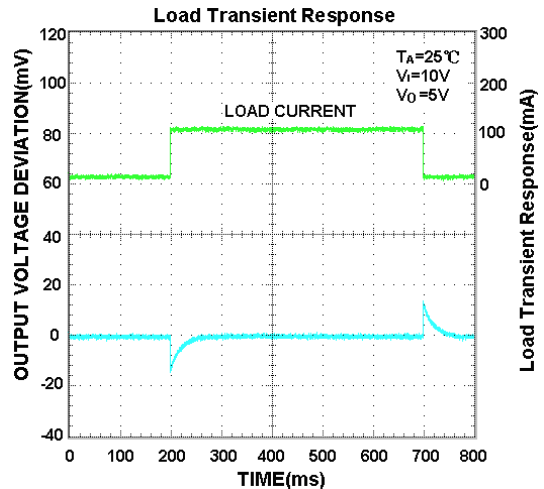
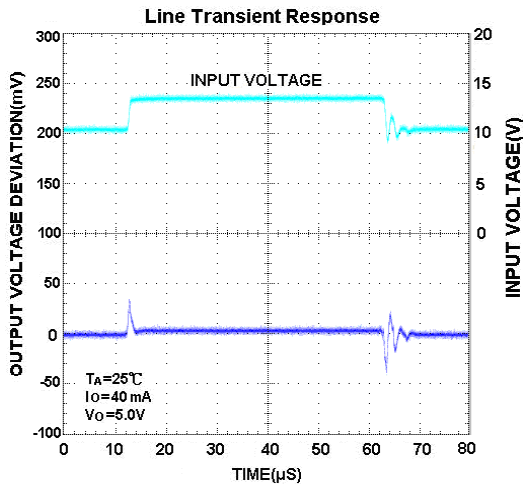
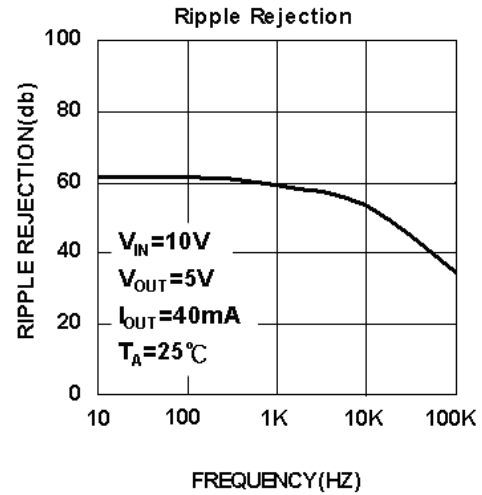
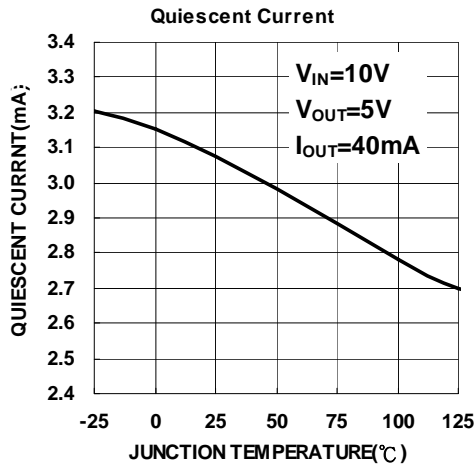
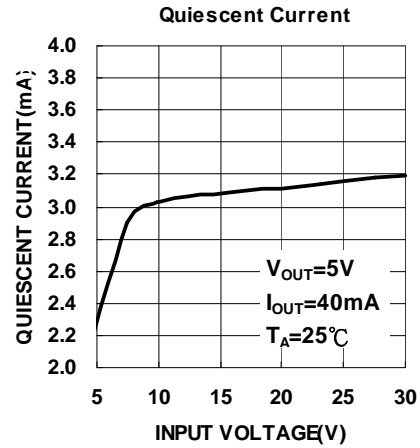
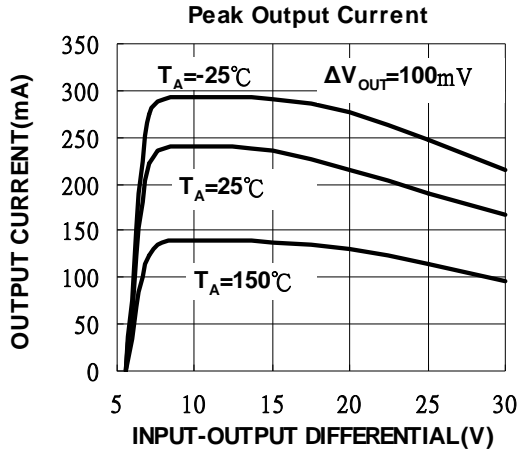

Typical Performance Characteristics (Continued)

For AP78L05

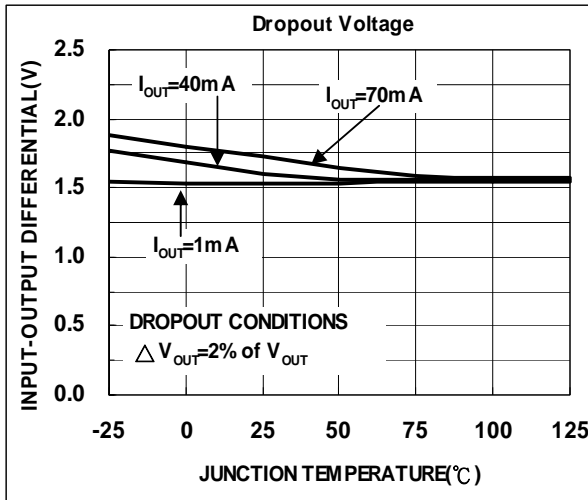

Typical Performance Characteristics (Continued)

For AP78L08

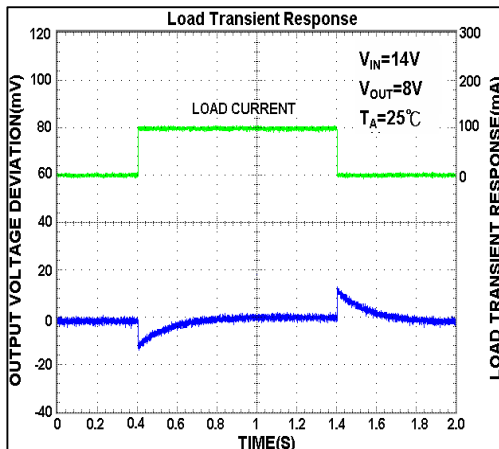
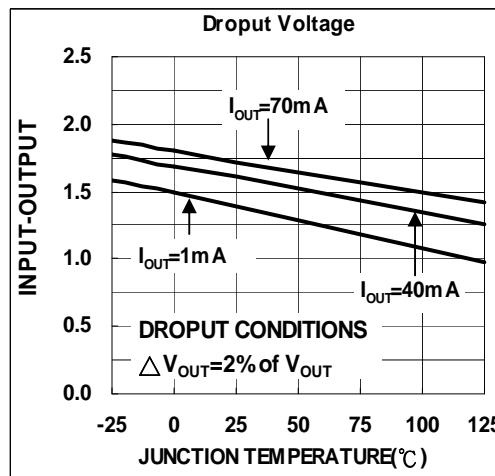
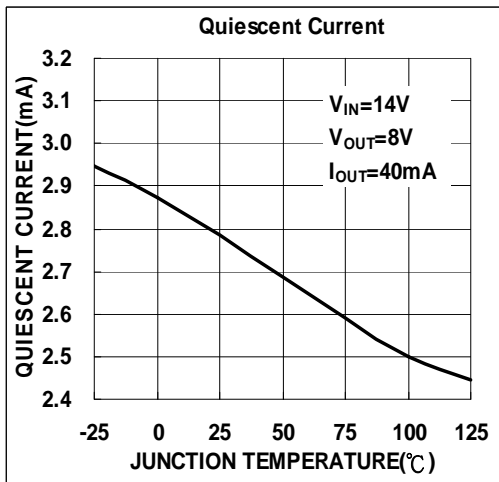
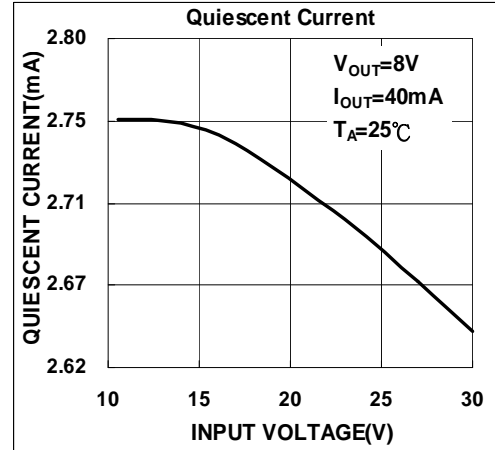
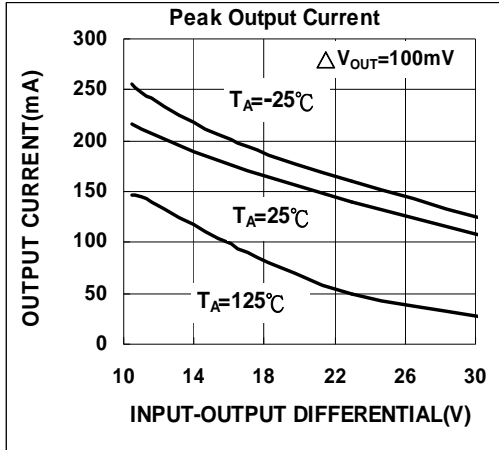

Typical Performance Characteristics (Continued)

For AP78L12

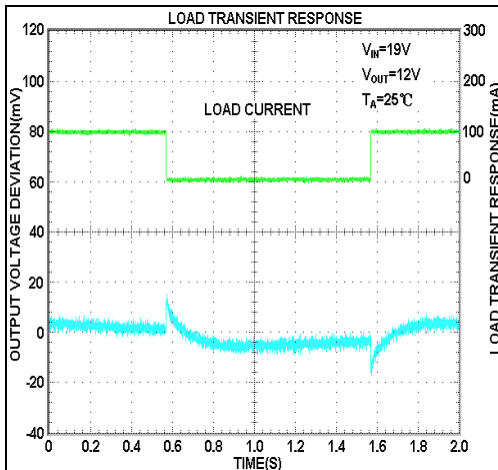
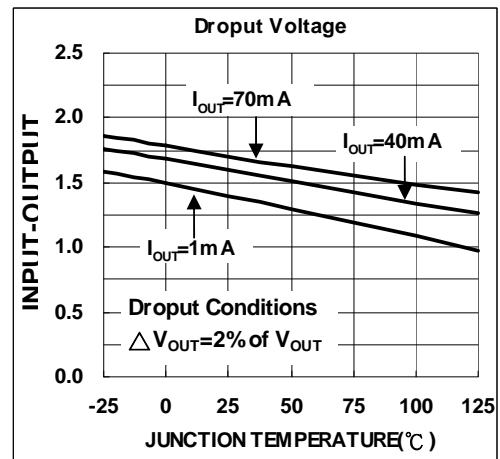
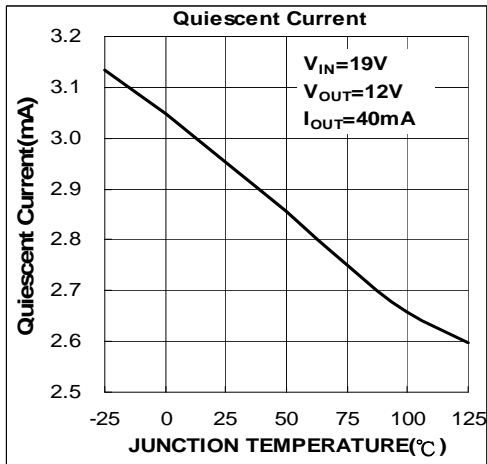
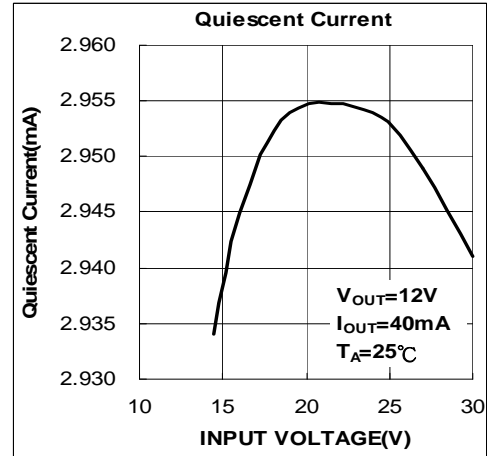
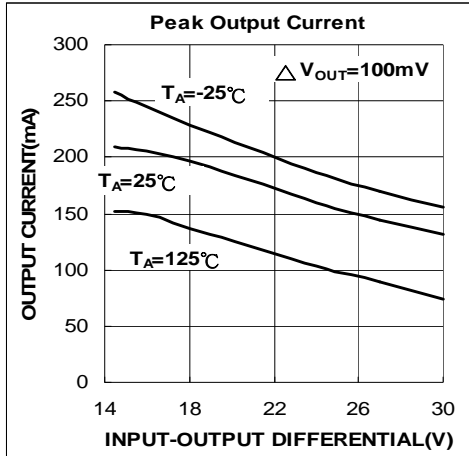

Typical Application Circuit

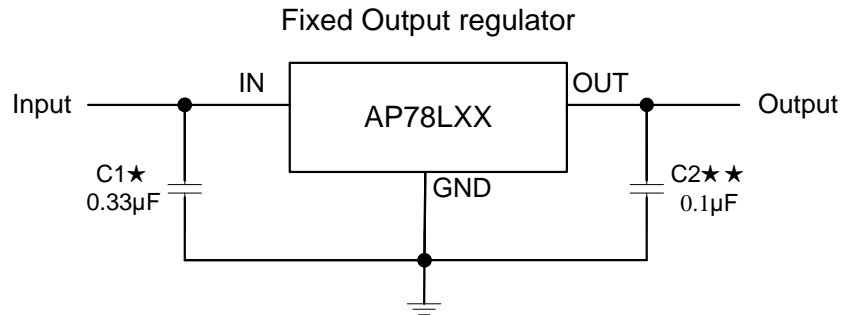

★ : Required if the regulator is located more than 3" from the power supply filter.

★★ : See (Note 5) in the electrical characteristics table.

Functional Description

Introduction

The AP78LXX series is a three terminal device with fixed output voltages from 5V, 8V and 12V. The AP78LXX fixed voltage regulator series has built-in thermal overload protection which prevents the device from being damaged due to excessive junction temperature. The regulator also contains internal short-circuit protection which limits the maximum output current, and safe-area protection for the pass transistor which reduces the short-circuit current as the voltage across the pass transistor is increased.

Marking Information

(1) TO92-3L

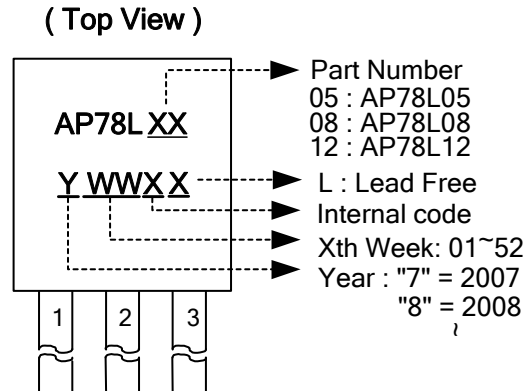

(2) SOP-8L

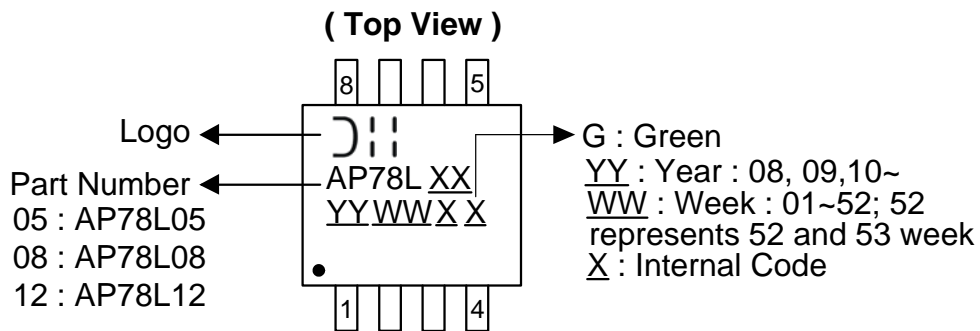

(3) SOT89-3L

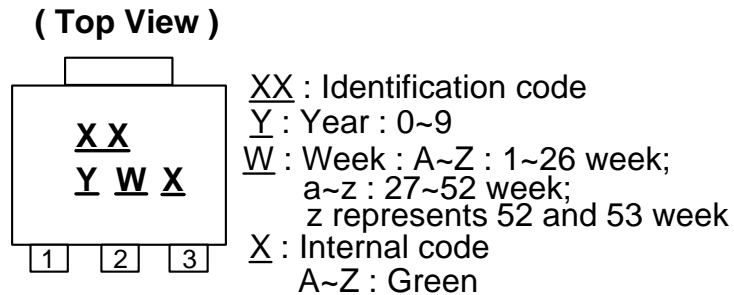

Device	Package	Identification Code
AP78L05	SOT89-3L	V2
AP78L08	SOT89-3L	V3
AP78L12	SOT89-3L	V4

Package Information (All Dimensions in mm)

(1) Package Type: TO92-3L

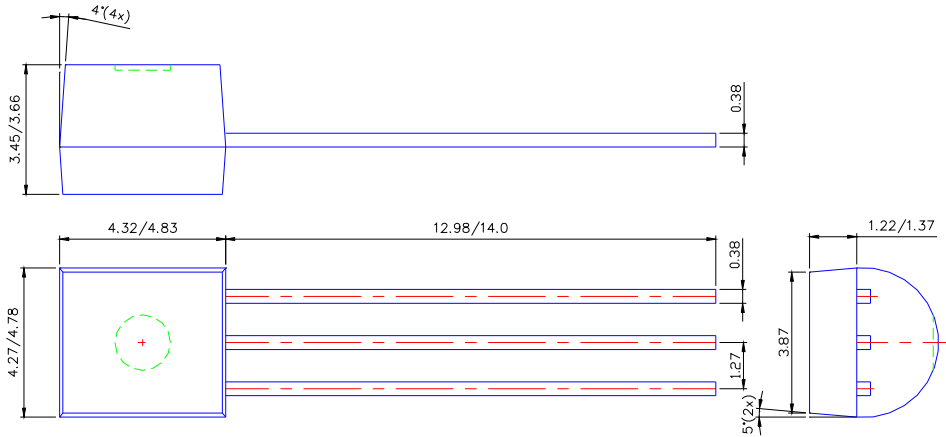

(2) TO92-3L for Ammo pack

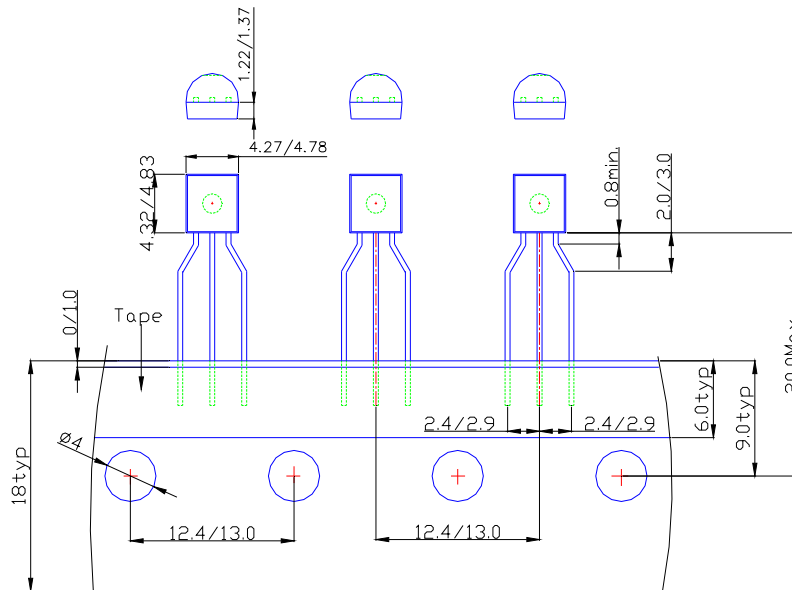

Package Information (Continued)

(3) Package Type: SOP-8L

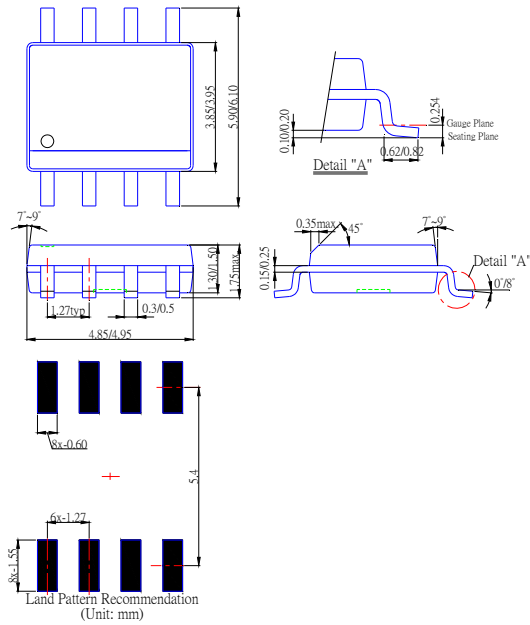

(4) Package Type: SOT89-3L

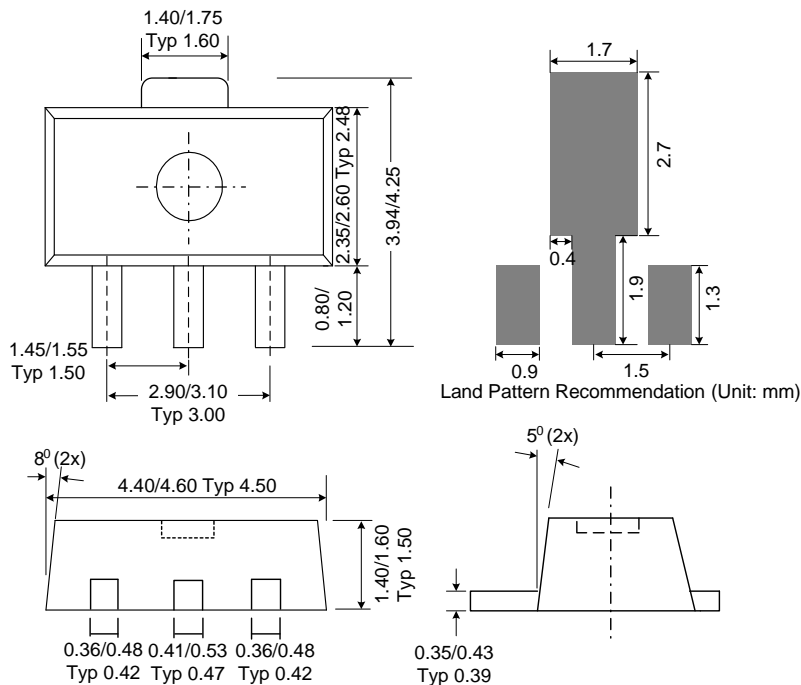

IMPORTANT NOTICE

Diodes Incorporated and its subsidiaries reserve the right to make modifications, enhancements, improvements, corrections or other changes without further notice to any product herein. Diodes Incorporated does not assume any liability arising out of the application or use of any product described herein; neither does it convey any license under its patent rights, nor the rights of others. The user of products in such applications shall assume all risks of such use and will agree to hold Diodes Incorporated and all the companies whose products are represented on our website, harmless against all damages.

LIFE SUPPORT

Diodes Incorporated products are not authorized for use as critical components in life support devices or systems without the expressed written approval of the President of Diodes Incorporated.