



## OSRAM GOLDEN DRAGON<sup>®</sup>

### 20mm LENSES AND HOLDERS



### OPERATING CONDITIONS

- ▲ 105° C max temperature

### MATERIALS/FINISH

- ▲ Lenses are optical grade PMMA acrylic
- ▲ Holders are made of durable polycarbonate

### MECHANICAL DIMENSIONS

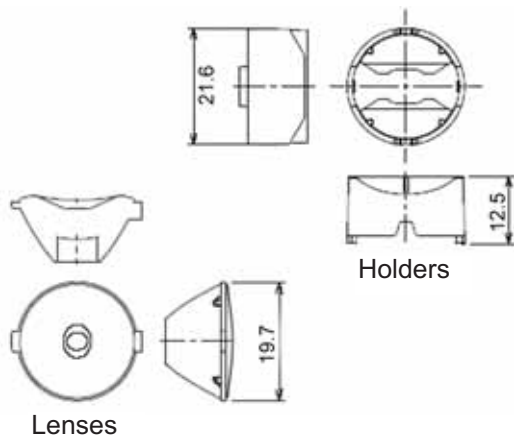

Dialight reserves the right to make changes at any time in order to supply the best product possible.

### FEATURES / BENEFITS

- ▲ For Osram Golden Dragon LEDs
- ▲ Available in spot, medium, wide and oval lenses
- ▲ Snap-in sub-lens
- ▲ Greater than 85% efficiency

### ORDERING INFORMATION

HOLDERS			
Dialight P/N	Reference P/N	Description	
OHGDBK	OH-GD-BK	Osram Golden Dragon LEDs - Black	
OHGDCL	OH-GD-CL	Osram Golden Dragon LEDs - Clear	
OHGDWH	OH-GD-WH	Osram Golden Dragon LEDs - White	
LENS			
Dialight P/N	Reference P/N	Description	Degree*
OP005	OP-005	Spot Lens	5°
OP015	OP-015	Medium Lens	15°
OP025	OP-025	Wide Lens	25°
OP520	OP-520	Oval Lens	5° X 20°
*All angles refer to half divergence			

### Dialight Corporation

1501 Route 34 South • Farmingdale, NJ 07727 USA

Tel: (1) 732-919-3119 • Fax: (1) 732-751-5778 • www.dialight.com



MDEXLUMOGD\_A



**PHOTOMETRIC DATA**

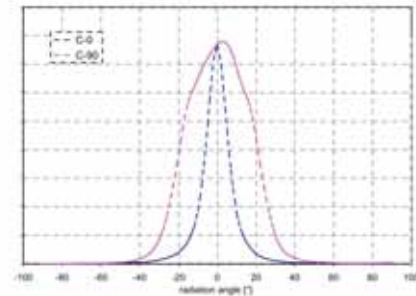
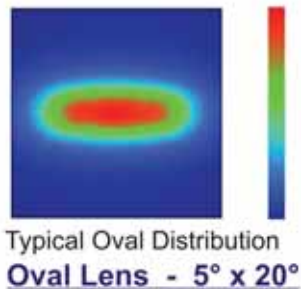
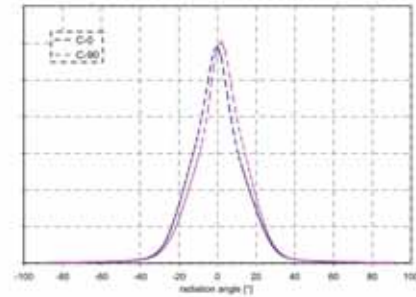
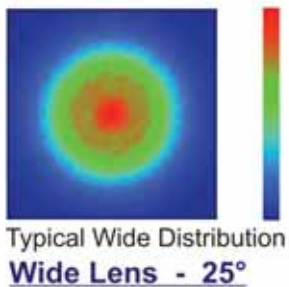
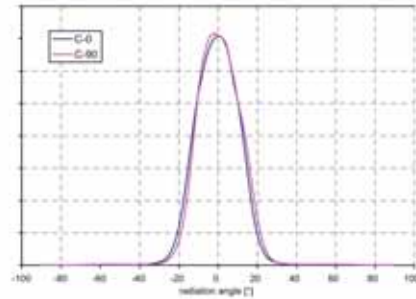
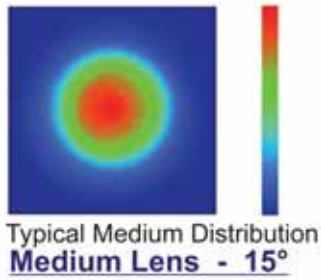
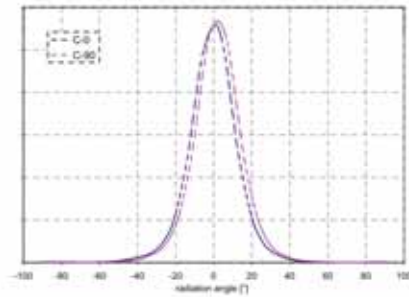
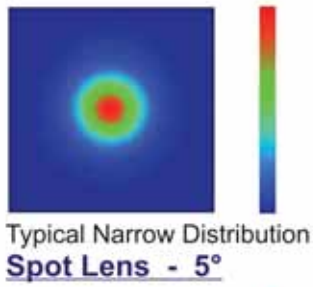

Dialight reserves the right to make changes at any time in order to supply the best product possible.



**Dialight Corporation**

1501 Route 34 South • Farmingdale, NJ 07727 USA  
Tel: (1) 732-919-3119 • Fax: (1) 732-751-5778 • www.dialight.com



MDEXLUMOGD\_A