

1.5V FM stereo demodulator

BA1362F/BA1362FS

The BA1362F and BA1362FS are FM stereo demodulator ICs designed for 1.5V audio systems. Both ICs have a PLL circuit that generates a 19kHz or 38kHz signal in synchronous with the input signal, a synchronous detector circuit that detects the presence or absence of a 19kHz pilot signal in the input signal, and a demodulation circuit that switches to divide the input signal into left and right channels. In addition, there is forced-monaural circuit that can turn the stereo signal into a monaural signal, and a stereo indicator LED driver circuit.

● Applications

1.5V headphone stereos

● Features

- 1) Excellent low-voltage characteristics (stereo operation down to 1.0V, monaural down to 0.9V, recommended operating voltage range 1.0V to 2.5V).
- 2) Gain can be set to either 0dB or 2.5dB by the input block wiring, with no external components.
- 3) VCO stop pin provided to prevent beat during AM operation.
- 4) Channel separation controlled by the input block high-frequency cut-off filter.
- 5) Output resistor that sets the de-emphasis is on the chip ($R_{OUT} \cong 5k\Omega$).
- 6) Built-in drive circuit for stereo indicator LED.
- 7) Good compatibility with the BA4230AFS 1.5V AM/FM IF system IC.

● Block diagram

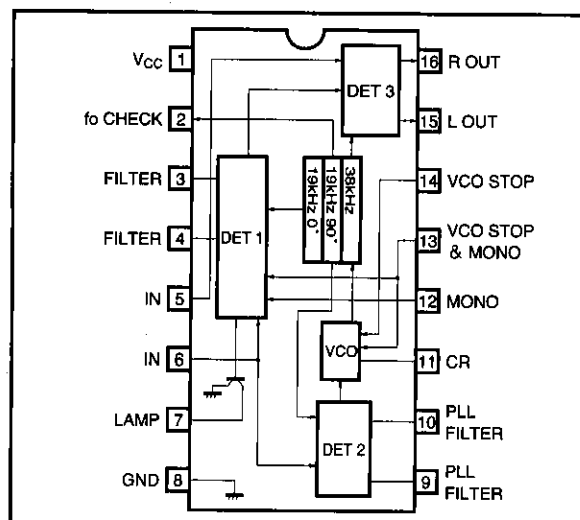

ROHM

97

Stereo multiplexers

High-frequency signal processors

● Absolute maximum ratings (Ta = 25°C)

| Parameter | Symbol | Limits | Unit |
|-----------------------|------------------|-------------------|------|
| Supply voltage | V _{CC} | 3.0 | V |
| Power dissipation | BA1362F | 300* ¹ | mW |
| | BA1362F S | 500* ² | |
| Operating temperature | T _{opr} | -25~75 | °C |
| Storage temperature | T _{stg} | -55~125 | °C |

* 1 Reduced by 3mW for each increase in Ta of 1°C over 25°C.

* 2 Reduced by 5mW for each increase in Ta of 1°C over 25°C.

● Recommended operating conditions (Ta = 25°C)

| Parameter | Symbol | Min | Typ. | Max. | Unit |
|----------------|-----------------|-----|------|------|------|
| Supply voltage | V _{CC} | 1.0 | 1.25 | 2.5 | V |

● Electrical characteristics (Ta = 25°C, V_{CC} = 1.25V, f = 1kHz, V_{IN} = 100mV, L + R = 90%, Pilot = 10%)

| Parameter | Symbol | Min. | Typ. | Max. | Unit | Conditions |
|---|--------------------|------|------|------|-------------------|----------------------------|
| Quiescent current | I _Q | 1.6 | 4 | 6.2 | mA | — |
| Separation | Sep | 30 | 35 | — | dB | Input phase compensation |
| Total harmonic distortion | THD | — | 0.3 | 0.8 | % | MAIN signal |
| Channel balance | CB | -2 | 0 | 2 | dB | MONO signal |
| LED ON level | V _P | 2.5 | 4.5 | 7.0 | mV _{rms} | PILOT signal only |
| LED hysteresis | Hys | — | 4.3 | 9.5 | dB | — |
| Input resistance | R _{IN} | 4.5 | 8.2 | 12.0 | kΩ | Pin 5, pin 6 shorted |
| Output resistance | R _{OUT} | 3.6 | 5.1 | 6.6 | kΩ | — |
| Input/output gain | G _V | — | 2.5 | — | dB | — |
| Signal-to-noise ratio | S/N | — | 68 | — | dB | — |
| Capture range | C _R | — | ±3 | — | % | MAIN signal |
| Forced monaural operating voltage | V _{CP12} | — | OPEN | — | — | Forced release by earthing |
| VCO stop voltage | V _{VCO14} | — | 0.9 | — | V | — |
| Pilot detector output pin pull-in current | I _P | — | 5 | — | mA | — |
| Input level | V _{IN} | 150 | — | — | mV | THD=6% |

● Circuit operation

(1) PLL circuit

The PLL circuit generates 19kHz and 38kHz signals that are synchronized with the 19kHz pilot contained in the composite signal, and uses them for the synchronous detector and as the demodulation signal for the stereo demodulation circuit.

The circuit is a closed circuit, and consists of a phase comparator, low-pass filter, VCO, and two divide-by-two frequency dividers. The capture range of the PLL is set by the CR filter circuit connected between pins 9 and 10, and the lock range and f_0 of the VCO are set by the time constant of the CR circuit connected between pin 11 and GND.

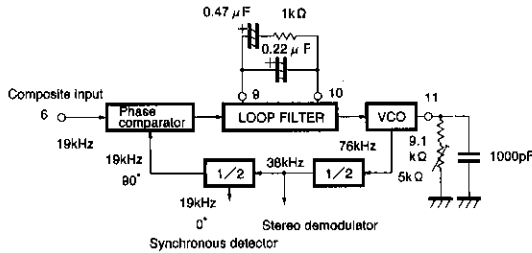

Fig. 3

(2) Synchronous detector circuit

Synchronous detection is performed by comparing the pilot signal in the composite signal (19kHz) and the 19kHz signal generated by the PLL to detect the presence of the pilot signal. The detector output is smoothed by a filter and used to turn the LED driver and stereo demodulation circuits on and off. The value of the capacitor connected between pins 3 and 4 sets the stereo/monaural switching time.

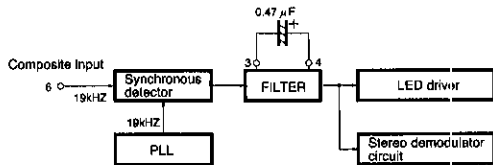

Fig. 4

(3) Stereo demodulator circuit

The stereo demodulator circuit switches the composite signal between the left and right channels at 38kHz to perform stereo demodulation. The composite signal is given by the following formula.

$$C(t) = (L+R) + (L-R) \cos \omega t + p \cos \frac{\omega t}{2}$$

ω : sub-carrier angular frequency

p : pilot signal amplitude

$$\omega t = 2n\pi \quad C(t) = (L+R) + (L-R) = 2L$$

$$\omega t = (2n+1)\pi \quad C(t) = (L+R) - (L-R) = 2R$$

The output impedance is set at 5kΩ, and pins 15 and 16 are connected via capacitors to GND to form the de-emphasis circuit.

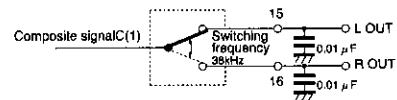

Fig. 5

(4) Monaural circuit

Stereo/monaural switching is done either automatically by the level of the pilot signal, or manually forced using pins 12, 13, and 14.

1) Automatic monaural switching

Automatically switches between stereo and monaural operation depending on the level of the pilot signal included in the composite signal. Some switching hysteresis is provided for stability.

2) Forced monaural operation

Force monaural operation by making pin 12 open circuit, and release it by pulling pin 12 down to GND. Pull pin 14 up to V_{CC} to stop the VCO oscillation, and make it open circuit to release the VCO. Pull pin 13 up to V_{CC} to simultaneously stop the VCO and force monaural operation, and make it open to release them.

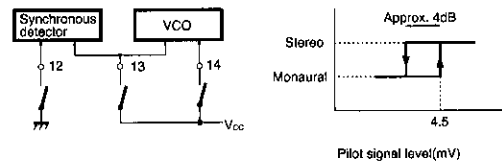

●Application circuit PCB layout

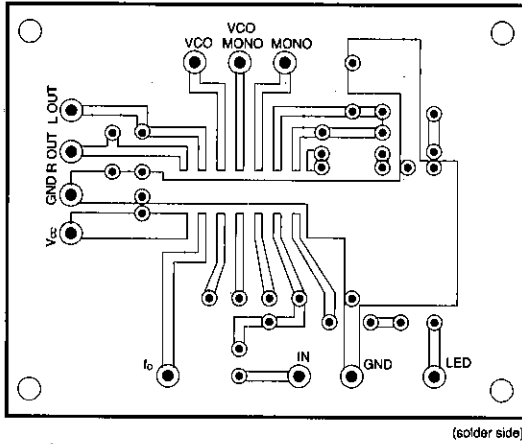

Fig. 6

●Application circuit component layout

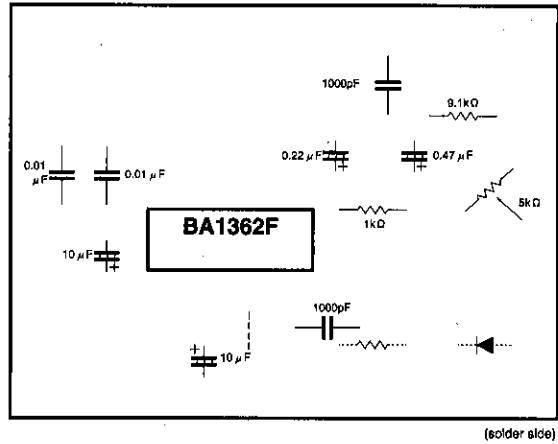

Fig. 7

●Electrical characteristics curves

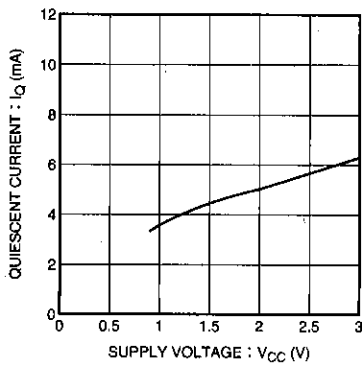

Fig. 8 Quiescent current vs. supply voltage

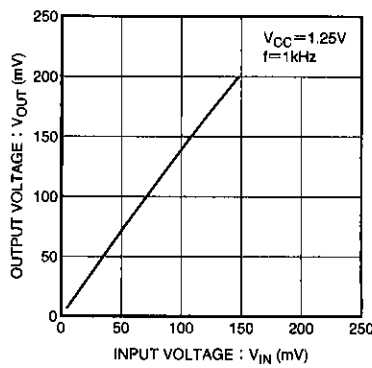

Fig. 9 Output voltage vs. input voltage

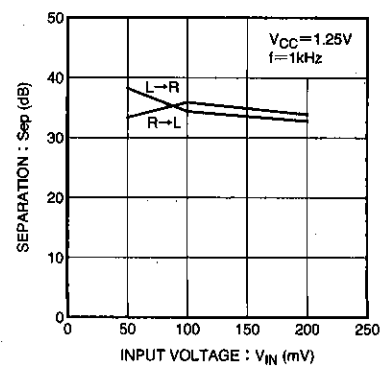

Fig. 10 Separation vs. input voltage

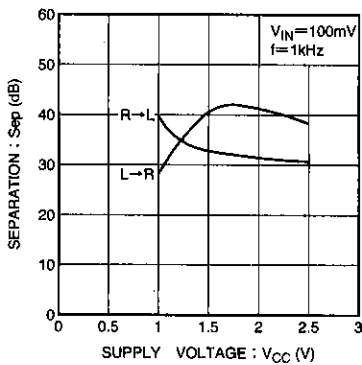

Fig. 11 Separation vs. supply voltage

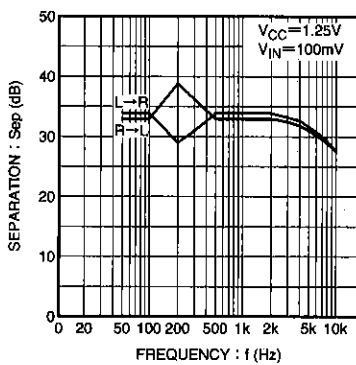

Fig. 12 Separation vs. frequency

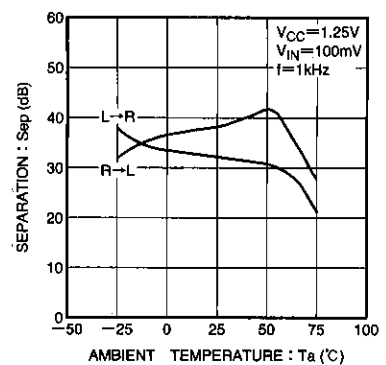

Fig. 13 Separation vs. ambient temperature

Stereo multiplexers

High-frequency signal processors

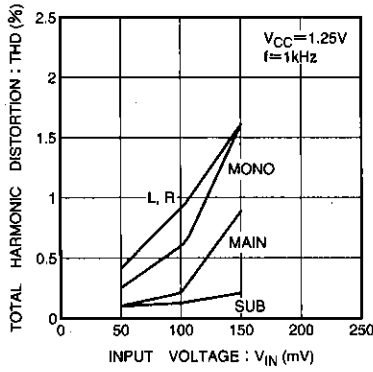

Fig. 14 Total harmonic distortion vs. input voltage

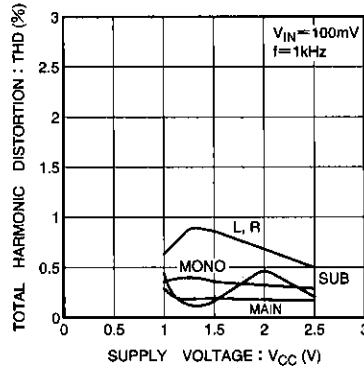

Fig. 15 Total harmonic distortion vs. supply voltage

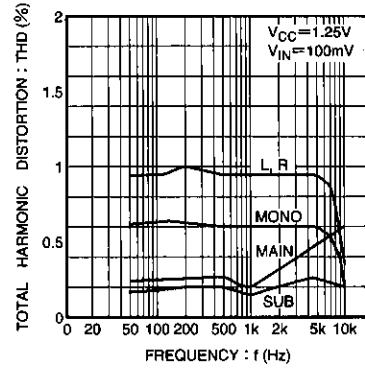

Fig. 16 Total harmonic distortion vs. frequency

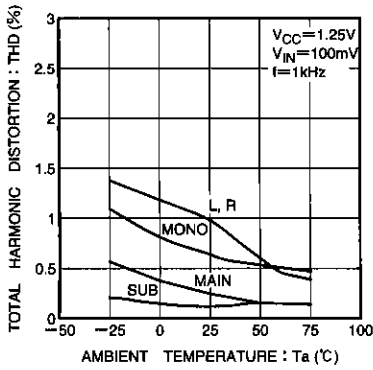

Fig. 17 Total harmonic distortion vs. ambient temperature

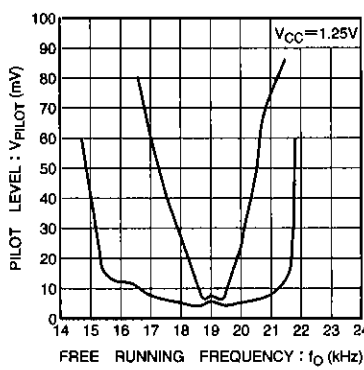

Fig. 18 Capture range and lock range vs. free-running frequency

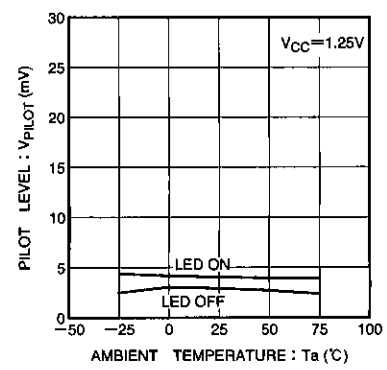

Fig. 19 LED ON/OFF levels vs. ambient temperature

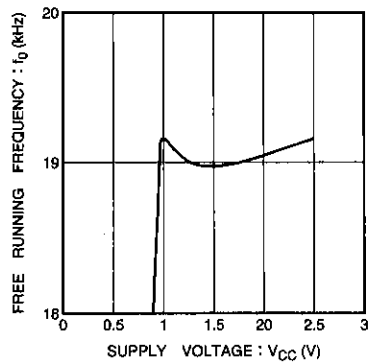

Fig. 20 Free-running frequency vs. supply voltage

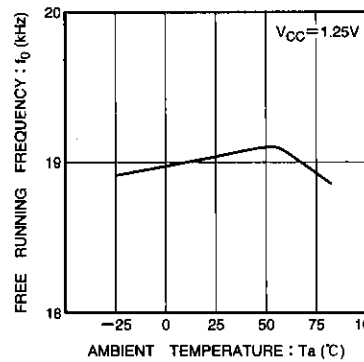

Fig. 21 Free-running frequency vs. ambient temperature

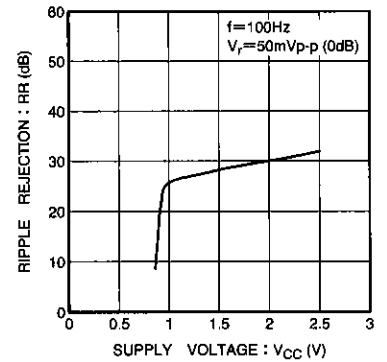

Fig. 22 Ripple rejection ratio vs. supply voltage

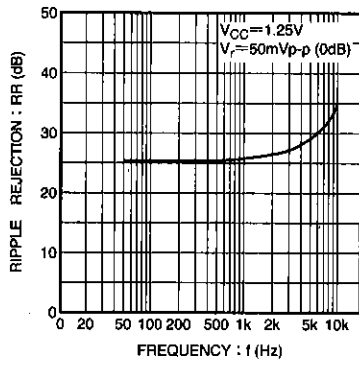
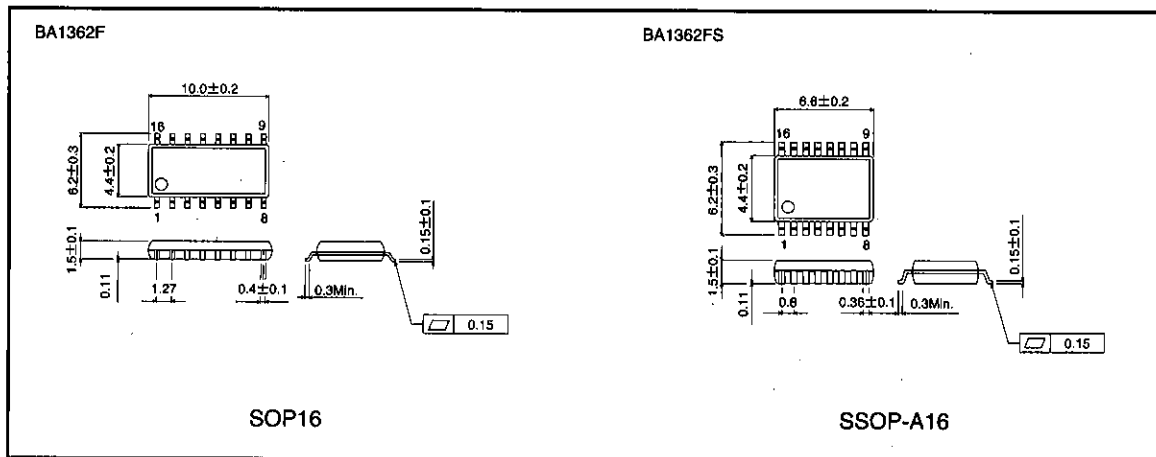

Fig. 23 Ripple rejection ratio vs. frequency

● External dimensions (Unit: mm)



Stereo multiplexers

High-frequency signal processors

Notes

- The contents described in this catalogue are correct as of March 1997.
- No unauthorized transmission or reproduction of this book, either in whole or in part, is permitted.
- The contents of this book are subject to change without notice. Always verify before use that the contents are the latest specifications. If, by any chance, a defect should arise in the equipment as a result of use without verification of the specifications, ROHM CO., LTD., can bear no responsibility whatsoever.
- Application circuit diagrams and circuit constants contained in this data book are shown as examples of standard use and operation. When designing for mass production, please pay careful attention to peripheral conditions.
- Any and all data, including, but not limited to application circuit diagrams, information, and various data, described in this catalogue are intended only as illustrations of such devices and not as the specifications for such devices. ROHM CO., LTD., disclaims any warranty that any use of such device shall be free from infringement of any third party's intellectual property rights or other proprietary rights, and further, assumes absolutely no liability in the event of any such infringement, or arising from or connected with or related to the use of such devices.
- Upon the sale of any such devices; other than for the buyer's right to use such devices itself, resell or otherwise dispose of the same; no express or implied right or license to practice or commercially exploit any intellectual property rights or other proprietary rights owned or controlled by ROHM CO., LTD., is granted to any such buyer.
- The products in this manual are manufactured with silicon as the main material.
- The products in this manual are not of radiation resistant design.

The products listed in this catalogue are designed to be used with ordinary electronic equipment or devices (such as audio-visual equipment, office-automation equipment, communications devices, electrical appliances, and electronic toys). Should you intend to use these products with equipment or devices which require an extremely high level of reliability and the malfunction of which would directly endanger human life (such as medical instruments, transportation equipment, aerospace machinery, nuclear-reactor controllers, fuel controllers, or other safety devices) please be sure to consult with our sales representatives in advance.

- Notes when exporting
 - It is essential to obtain export permission when exporting any of the above products when it falls under the category of strategic material (or labor) as determined by foreign exchange or foreign trade control laws.
 - Please be sure to consult with our sales representatives to ascertain whether any product is classified as a strategic material.