

**Product Specification**

# SPECIFICATION FOR APPROVAL

( ) Preliminary Specification  
(? ) Final Specification

|       |                           |
|-------|---------------------------|
| Title | <b>19.0" SXGA TFT LCD</b> |
|-------|---------------------------|

|       |                |
|-------|----------------|
| BUYER | <b>General</b> |
| MODEL |                |

|          |                                 |
|----------|---------------------------------|
| SUPPLIER | <b>LG.Philips LCD Co., Ltd.</b> |
| *MODEL   | <b>LM190E05</b>                 |
| SUFFIX   | <b>SL03</b>                     |

\*When you obtain standard approval, please use the above model name without suffix

| SIGNATURE | DATE  |
|-----------|-------|
| /         | _____ |
| /         | _____ |
| /         | _____ |

Please return 1 copy for your confirmation with your signature and comments.

| APPROVED BY        | DATE  |
|--------------------|-------|
| G.T. Kim / Manager | _____ |
| <b>REVIEWED BY</b> |       |
| K.J. Kwon/ Manager | _____ |
| <b>PREPARED BY</b> |       |
| J.Y.Lee / Engineer | _____ |

**Product Engineering Dept.  
LG. Philips LCD Co., Ltd**

**Product Specification**
**CONTENTS**

| <b>NO.</b> | <b>ITEM</b>                  | <b>Page</b> |
|------------|------------------------------|-------------|
| -          | COVER                        | 1           |
| -          | CONTENTS                     | 2           |
| -          | RECORD OF REVISIONS          | 3           |
| 1          | GENERAL DESCRIPTION          | 4           |
| 2          | ABSOLUTE MAXIMUM RATINGS     | 5           |
| 3          | ELECTRICAL SPECIFICATIONS    | 6           |
| 3-1        | ELECTRICAL CHARACTERISTICS   | 6           |
| 3-2        | INTERFACE CONNECTIONS        | 9           |
| 3-3        | SIGNAL TIMING SPECIFICATIONS | 13          |
| 3-4        | SIGNAL TIMING WAVEFORMS      | 14          |
| 3-5        | COLOR INPUT DATA REFERANCE   | 15          |
| 3-6        | POWER SEQUENCE               | 16          |
| 4          | OPTICAL SPECIFICATIONS       | 17          |
| 5          | MECHANICAL CHARACTERISTICS   | 22          |
| 6          | RELIABILITY                  | 25          |
| 7          | INTERNATIONAL STANDARDS      | 26          |
| 7-1        | SAFETY                       | 26          |
| 7-2        | EMC                          | 26          |
| 8          | PACKING                      | 27          |
| 8-1        | DESIGNATION OF LOT MARK      | 27          |
| 8-2        | PACKING FORM                 | 27          |
| 9          | PRECAUTIONS                  | 28          |

**Product Specification**

**RECORD OF REVISIONS**

| Revision No | Date          | Page | Description                |
|-------------|---------------|------|----------------------------|
| Ver 0.0     | Jun. 03. 2005 |      | Preliminary Specifications |

**Product Specification**

**1. General Description**

The LM190E05-SL03 is a Color Active Matrix Liquid Crystal Display with an integral Cold Cathode Fluorescent Lamp(CCFL) backlight system. The matrix employs a-Si Thin Film Transistor as the active element. It is a transmissive type display operating in the normally black mode. This TFT-LCD has a 19.0 inch diagonal measured active display area with SXGA resolution(1024 vertical by 1280 horizontal pixel array) Each pixel is divided into Red, Green and Blue sub-pixels or dots which are arranged in vertical stripes. Gray scale or the brightness of the sub-pixel color is determined with a 8-bit gray scale signal for each dot, thus, presenting a palette of more than 16.7M colors.

The LM190E05-SL03 has been designed to apply the interface method that enables low power, high speed, low EMI. FPD Link or compatible must be used as a LVDS(Low Voltage Differential Signaling) chip. The LM190E05-SL03 is intended to support applications where thin thickness, wide viewing angle, low power are critical factors and graphic displays are important. In combination with the vertical arrangement of the sub-pixels, the LM190E05-SL03 characteristics provide an excellent flat panel display for office automation products such as monitors.

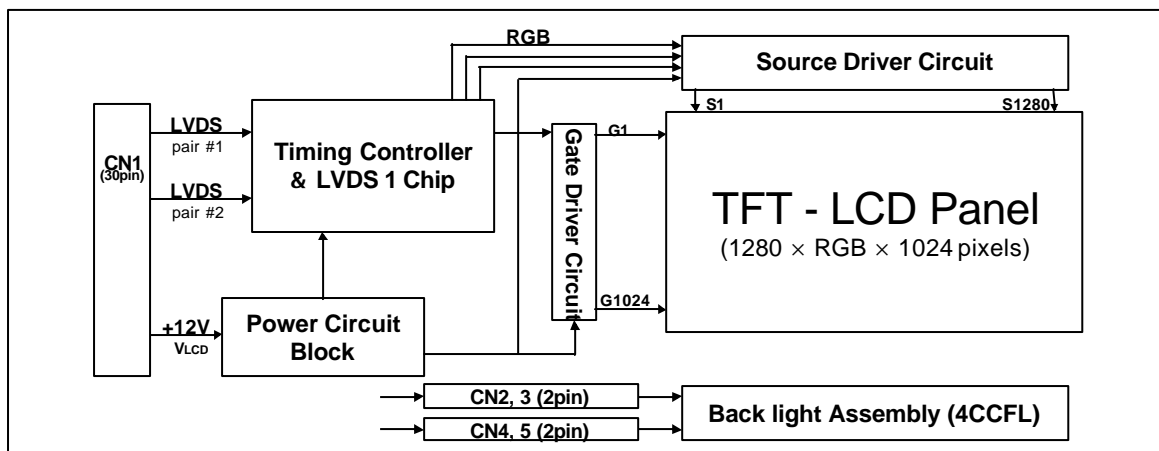

**Figure 1. Block diagram**

**General Features**

|                        |   |
|------------------------|---|
| Active screen size     | 19.0 inch (481.84mm) diagonal   |
| Outline Dimension      | 396.0(H) x 324.0(V) x 20.0(D) mm(Typ.)  |
| Pixel Pitch            | 0.294 xRGB(H)mm x 0.294(V) mm   |
| Pixel Format           | 1280 horiz. by 1024 vert. Pixels. RGB stripe arrangement                        |
| Display Colors         | 8bit (16.7M colors)   |
| Luminance, white       | 270 cd/m <sup>2</sup> (Typ. Center 1 point)                                     |
| Viewing Angle (CR>10)  | Viewing Angle Free [ R/L 178(Typ.), U/D 178(Typ.) ]                             |
| Power Consumption      | Total 25.15 Watt(Typ.), (5.5 Watt @ V <sub>LCD</sub> , 19.65Watt @[Lamp=7.5mA]) |
| Weight                 | 2,970 g (Typ.)  |
| Display operating mode | Transmissive mode, normally black   |
| Surface treatments     | Hard coating (3H), Anti-glare treatment of the front polarizer                  |

**Product Specification**

**2. Absolute maximum ratings**

The followings are maximum values which, if exceeded, may cause faulty operation or damage to the unit.

**Table 1. Absolute Maximum Ratings**

| Parameter                  | Symbol    | Values |        | Units    | Notes  |
|----------------------------|-----------|--------|--------|----------|--------|
|                            |           | Min.   | Max.   |          |        |
| Power Supply Input Voltage | $V_{LCD}$ | - 0.3  | + 14.0 | $V_{dc}$ | At 25? |
| Operating Temperature      | $T_{OP}$  | 0      | + 50   | ?        | 1      |
| Storage Temperature        | $T_{ST}$  | - 20   | + 60   | ?        | 1      |
| Operating Ambient Humidity | $H_{OP}$  | 10     | + 90   | %RH      | 1      |
| Storage Humidity           | $H_{ST}$  | 10     | + 90   | %RH      | 1      |

Note : 1. Temperature and relative humidity range are shown in the figure below.  
Wet bulb temperature should be 39°C Max, and no condensation of water.

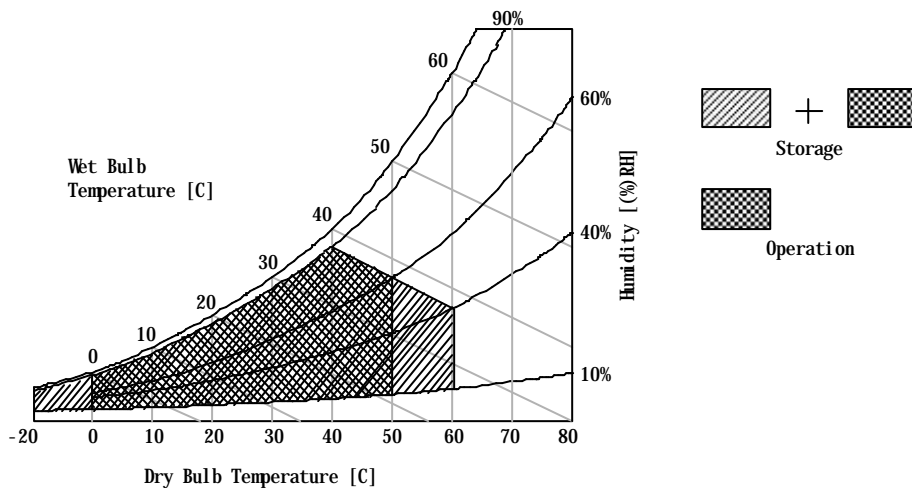

**Figure 2. Temperature and relative humidity**

**Product Specification**

**3. Electrical specifications**

**3-1. Electrical characteristics**

The LM190E05-SL03 requires two power inputs. One is employed to power the LCD electronics and to drive the TFT array and liquid crystal. Another which powers the CCFL, is typically generated by an inverter. The inverter is an external unit to the LCD.

**Table 2. Electrical Characteristics**

| Parameter                  | Symbol     | Values |      |      | Units | Notes |
|----------------------------|------------|--------|------|------|-------|-------|
|                            |            | Min.   | Typ. | Max. |       |       |
| <b>MODULE :</b>            |            |        |      |      |       |       |
| Power Supply Input Voltage | $V_{LCD}$  | 10.8   | 12.0 | 13.2 | V     |       |
| Power Supply Input Current | $I_{LCD}$  | -      | 0.46 | 0.53 | A     | 1     |
|                            | $I_{LCD}$  | -      | 0.59 | 0.68 | A     | 2     |
| Differential Impedance     | $Z_m$      | 90     | 100  | 110  | ohm   |       |
| Power Consumption          | $P_{LCD}$  | -      | 5.5  | 7.0  | Watts | 1     |
| Rush Current               | $I_{RUSH}$ | -      | 2.0  | 3.0  | A     | 3     |

Notes :

1. The specified current and power consumption are under the  $V_{LCD}=12.0V$ ,  $25 \pm 2^\circ C$ ,  $f_v=60Hz$  condition whereas mosaic pattern(8 x 6) is displayed and  $f_v$  is the frame frequency.
2. The current is specified at the maximum current pattern.
3. The duration of rush current is about 5ms and rising time of power Input is  $500\mu s \pm 20\%$ .

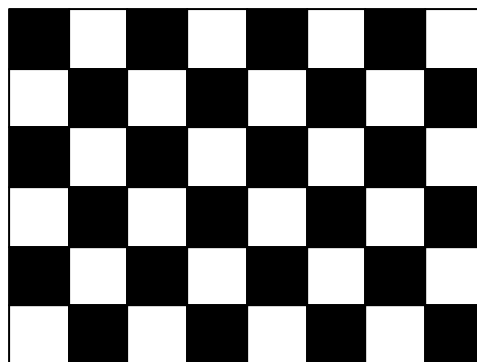

White : 255Gray  
Black : 0Gray

[ Figure 3 ] Mosaic pattern (8X6) for power consumption measurement

**Product Specification**

**Table 3. Electrical Characteristics**

| Parameter                                | Symbol   | Values          |                 |                 | Units      | Notes |
|--|----------|-----------------|-----------------|-----------------|------------|-------|
|  |          | Min.            | Typ.            | Max.            |            |       |
| LAMP for each CCFL:<br>Operating Voltage | $V_{BL}$ | 645<br>(@8.0mA) | 655<br>(@7.5mA) | 790<br>(@3.0mA) | $V_{RMS}$  | 1,2   |
| Operating Current                        | $I_{BL}$ | 3.0             | 7.5             | 8.0             | $mA_{RMS}$ | 1     |
| Established Starting Voltage             | $V_{BS}$ | -               | -               | 1100            | $V_{RMS}$  | 1,3   |
| at 25 °C                                 |          | -               | -               | 1400            | $V_{RMS}$  |       |
| at 0 °C                                  |          | -               | -               | -               | $V_{RMS}$  |       |
| Operating Frequency                      | $f_{BL}$ | 40              | 60              | 70              | KHz        | 4     |
| Discharge Stabilization Time             | $T_S$    | -               | -               | 3               | Minutes    | 1,5   |
| Power Consumption                        | $P_{BL}$ | -               | 19.65           | 21.62           | Watts      | 6     |
| Life Time                                |          | 40,000          | -               | -               | Hrs        | 1,7   |

Notes :

The design of the inverter must have specifications for the lamp in LCD Assembly.

The performance of the Lamp in LCM, for example life time or brightness, is extremely influenced by the characteristics of the DC-AC inverter. So all the parameters of an inverter should be carefully designed so as not to produce too much leakage current from high-voltage output of the inverter.

When you design or order the inverter, please make sure unwanted lighting caused by the mismatch of the lamp and the inverter (no lighting, flicker, etc) never occurs. When you confirm it, the LCD-Assembly should be operated in the same condition as installed in your instrument.

- ? Do not attach a conducting tape to lamp connecting wire. If the lamp wire attach to a conducting tape, TFT-LCD Module has a low luminance and the inverter has abnormal action.  
Because leakage current is occurred between lamp wire and conducting tape.

1. Specified values are for a single lamp.
2. Operating voltage is measured at  $25 \pm 2^\circ\text{C}$ . The variance of the voltage is  $\pm 10\%$ .
3. The voltage above  $V_s$  should be applied to the lamps for more than 1 second for start-up.  
(Inverter open voltage must be more than lamp starting voltage.)

Otherwise, the lamps may not be turned on. The used lamp current is the lamp typical current.

4. Lamp frequency may produce interface with horizontal synchronous frequency and as a result this may cause beat on the display. Therefore lamp frequency shall be as away possible from the horizontal synchronous frequency and from its harmonics in order to prevent interference.
5. Let's define the brightness of the lamp after being lighted for 5 minutes as 100%.  
 $T_s$  is the time required for the brightness of the center of the lamp to be not less than 95%.
6. The lamp power consumption shown above does not include loss of external inverter.  
The used lamp current is the lamp typical current. ( $P_{BL} = V_{BL} \times I_{BL} \times N_{Lamp}$ )
7. The life is determined as the time at which brightness of the lamp is 50% compared to that of initial value at the typical lamp current on condition of continuous operating at  $25 \pm 2^\circ\text{C}$ .

**Product Specification**



**Product Specification**

**3-2. Interface Connections**

Interface chip must be used LVDS, part No. SN75LVDS83 (Tx, Texas Instrument) or compatible.  
 This LCD employs a interface connection, a 30 pin connector is used for the module electronics interface.  
 Four 2pin connectors are used for the integral backlight system. The electronics interface connector is a model GT101-30S-H16 (LG Cable) or IN-30-BA 10 ( UJU Electronics) which is compatible.  
 And mating connector is FI-X30H (JAE) or compatible.  
 The pin configuration for the connector is shown in the table 4 and the signal mapping with LVDS transmitter is shown in the table 5.

**Table 4. Module connector pin configuration**

| Pin No | Symbol | Description                          |
|--------|--------|--------------------------------------|
| 1      | RxO0-  | LVDS Signal of Odd Channel 0(-)      |
| 2      | RxO0+  | LVDS Signal of Odd Channel 0(+)      |
| 3      | RxO1-  | LVDS Signal of Odd Channel 1(-)      |
| 4      | RxO1+  | LVDS Signal of Odd Channel 1(+)      |
| 5      | RxO2-  | LVDS Signal of Odd Channel 2(-)      |
| 6      | RxO2+  | LVDS Signal of Odd Channel 2(+)      |
| 7      | GND    | Ground                               |
| 8      | RxOC-  | LVDS Signal of Odd Channel Clock(-)  |
| 9      | RxOC+  | LVDS Signal of Odd Channel Clock(+)  |
| 10     | RxO3-  | LVDS Signal of Odd Channel 3(-)      |
| 11     | RxO3+  | LVDS Signal of Odd Channel 3(+)      |
| 12     | RxE0-  | LVDS Signal of Even Channel 0(-)     |
| 13     | RxE0+  | LVDS Signal of Even Channel 0(+)     |
| 14     | GND    | Ground                               |
| 15     | RxE1-  | LVDS Signal of Even Channel 1(-)     |
| 16     | RxE1+  | LVDS Signal of Even Channel 1(+)     |
| 17     | GND    | Ground                               |
| 18     | RxE2-  | LVDS Signal of Even Channel 2(-)     |
| 19     | RxE2+  | LVDS Signal of Even Channel 2(+)     |
| 20     | RxEC-  | LVDS Signal of Even Channel Clock(-) |
| 21     | RxEC+  | LVDS Signal of Even Channel Clock(+) |
| 22     | RxE3-  | LVDS Signal of Even Channel 3(-)     |
| 23     | RxE3+  | LVDS Signal of Even Channel 3(+)     |
| 24     | GND    | Ground                               |
| 25     | NC     | No connection                        |
| 26     | NC     | No connection                        |
| 27     | NC     | No connection                        |
| 28     | VCC    | Power supply (12.0V Typ.)            |
| 29     | VCC    | Power supply (12.0V Typ.)            |
| 30     | VCC    | Power supply (12.0V Typ.)            |

First Pixel Data

Second Pixel Data

**Product Specification**GT101-30S-H16(LGC) or  
IN-30-BA 10 (UJU)**Rear view of LCM****[ Figure 4 ] Connector diagram**

- Notes:
1. All GND(ground) pins should be connected together and should also be connected to the LCD's metal frame.
  2. All  $V_{LCD}$ (power input) pins should be connected together.
  3. All NC pins should be separated from other signal or power.

**Product Specification**
**Table 5. Required signal assignment for Flat Link (TI:SN75LVDS83) Transmitter**

| Pin | Pin Name | Require Signal             | Pin | Pin Name   | Require Signal                          |
|-----|----------|----------------------------|-----|------------|---|
| 1   | VCC      | Power Supply for TTL Input | 29  | GND        | Ground pin for TTL                      |
| 2   | D5       | TTL Input(R7)              | 30  | D26        | TTL Input(DE)                           |
| 3   | D6       | TTL Input(R5)              | 31  | TxCLKIN    | TTL Level clock Input                   |
| 4   | D7       | TTL Input(G0)              | 32  | PWR DWN    | Power Down Input                        |
| 5   | GND      | Ground pin for TTL         | 33  | PLL GND    | Ground pin for PLL                      |
| 6   | D8       | TTL Input(G1)              | 34  | PLL VCC    | Power Supply for PLL                    |
| 7   | D9       | TTL Input(G2)              | 35  | PLL GND    | Ground pin for PLL                      |
| 8   | D10      | TTL Input(G6)              | 36  | LVDS GND   | Ground pin for LVDS                     |
| 9   | VCC      | Power Supply for TTL Input | 37  | TxOUT3+    | Positive LVDS differential data output3 |
| 10  | D11      | TTL Input(G7)              | 38  | TxOUT3-    | Negative LVDS differential data output3 |
| 11  | D12      | TTL Input(G3)              | 39  | TxCLKOUT+  | Positive LVDS differential clock output |
| 12  | D13      | TTL Input(G4)              | 40  | TxCLKOUT - | Negative LVDS differential clock output |
| 13  | GND      | Ground pin for TTL         | 41  | TxOUT2+    | Positive LVDS differential data output2 |
| 14  | D14      | TTL Input(G5)              | 42  | TxOUT2-    | Negative LVDS differential data output2 |
| 15  | D15      | TTL Input(B0)              | 43  | LVDS GND   | Ground pin for LVDS                     |
| 16  | D16      | TTL Input(B6)              | 44  | LVDS VCC   | Power Supply for LVDS                   |
| 17  | VCC      | Power Supply for TTL Input | 45  | TxOUT1+    | Positive LVDS differential data output1 |
| 18  | D17      | TTL Input(B7)              | 46  | TxOUT1-    | Negative LVDS differential data output1 |
| 19  | D18      | TTL Input(B1)              | 47  | TxOUT0+    | Positive LVDS differential data output0 |
| 20  | D19      | TTL Input(B2)              | 48  | TxOUT0-    | Negative LVDS differential data output0 |
| 21  | GND      | Ground pin for TTL Input   | 49  | LVDS GND   | Ground pin for TTL                      |
| 22  | D20      | TTL Input(B3)              | 50  | D27        | TTL Input(R6)                           |
| 23  | D21      | TTL Input(B4)              | 51  | D0         | TTL Input(R0)                           |
| 24  | D22      | TTL Input(B5)              | 52  | D1         | TTL Input(R1)                           |
| 25  | D23      | TTL Input(RSVD)            | 53  | GND        | Ground pin for TTL                      |
| 26  | VCC      | Power Supply for TTL Input | 54  | D2         | TTL Input(R2)                           |
| 27  | D24      | TTL Input(HSYNC)           | 55  | D3         | TTL Input(R3)                           |
| 28  | D25      | TTL Input(VSYNC)           | 56  | D4         | TTL Input(R4)                           |

Notes : 1. Refer to LVDS Transmitter Data Sheet for detail descriptions.  
 2. 7 means MSB and 0 means LSB at R,G,B pixel data

**Product Specification**

The backlight interface connector is a model BHSR-02VS-1(JST) or 1674817-1(AMP) which is compatible. The mating connector is SM02B-BHSS-1 or equivalent. The pin configuration for the connector is shown in the table below.

**Table 6. Backlight connector pin configuration**

| Pin | Symbol | Description           | NOTES |
|-----|--------|-----------------------|-------|
| 1   | HV     | High Voltage for Lamp | 1     |
| 2   | LV     | Low Voltage for Lamp  | 2     |

- Notes: 1. The high voltage power terminal is colored gray, sky blue.  
2. The low voltage pin color is black, blue.

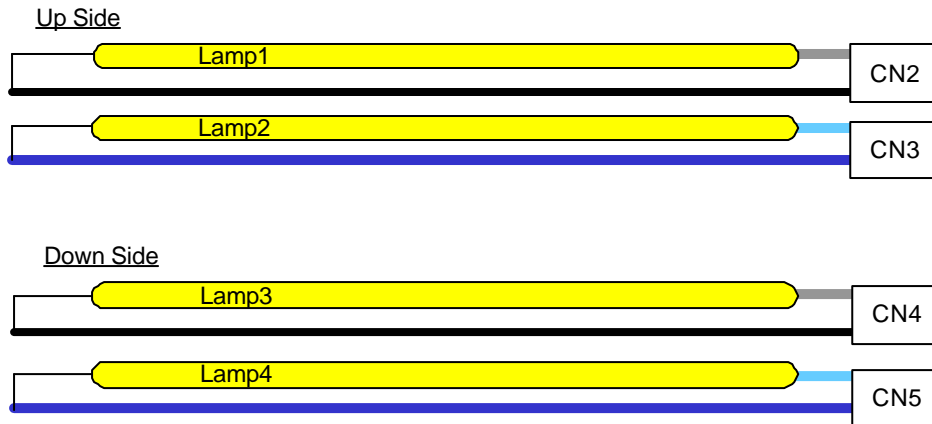

[ Figure 5 ] Backlight connector view

## Product Specification

### 3-3. Signal Timing Specifications

This is the signal timing required at the input of the LVDS Transmitter. All of the interface signal timing should be satisfied with the following specifications for its proper operation.

**Table 7. Timing table**

| Parameter           |                        | Symbol | Min. | Typ. | Max. | Unit | Notes    |
|---------------------|------------------------|--------|------|------|------|------|----------|
| Dclk                | Period                 | tCLK   | 14.7 | 18.5 | 22.2 | ns   |          |
|                     | Frequency              | fCLK   | 45.0 | 54.0 | 68.4 | MHz  |          |
| Hsync               | Period                 | tHP    | 672  | 844  | 1022 | tCLK |          |
|                     | Width                  | tWH    | 8    | 56   | -    |      |          |
|                     | Frequency              | fH     | 53.3 | 64.0 | 82.1 | kHz  |          |
| Vsync               | Period                 | tVP    | 1034 | 1066 | 1320 | tHP  |          |
|                     | Width                  | tWV    | 2    | 3    | 24   |      |          |
|                     | Frequency              | fV     | 47   | 60   | 76   | Hz   |          |
| DE<br>(Data Enable) | Horizontal Valid       | tHV    | 640  | 640  | 640  | tCLK |          |
|                     | Horizontal Back Porch  | tHBP   | 8    | 124  | -    |      |          |
|                     | Horizontal Front Porch | tHFP   | 8    | 24   | -    |      |          |
|                     | -                      | -      | -    | -    | -    |      |          |
|                     | Vertical Valid         | tVV    | 1024 | 1024 | 1024 | tHP  |          |
|                     | Vertical Back Porch    | tVBP   | 5    | 38   | 124  |      |          |
|                     | Vertical Front Porch   | tVFP   | 1    | 1    | -    |      |          |
|                     | -                      | -      | -    | -    | -    |      |          |
|                     | DE setup time          | tSI    | 4    | -    | -    | ns   | For Dclk |
|                     | DE hold time           | tHI    | 4    | -    | -    |      |          |
| Data                | Data setup time        | tSD    | 4    | -    | -    | ns   | For Dclk |
|                     | Data hold time         | tHD    | 4    | -    | -    |      |          |

- Notes :
1. DE mode operation
  2.  $tHFP + tWH + tHBP < (1/2) tHV$
  3. The performance of the electro-optical characteristics may be influenced by variance of the vertical refresh rates.
  4. tHFP, tWH and tHBP should be any times of a character number (8).

Product Specification

3-4. Signal Timing Waveforms

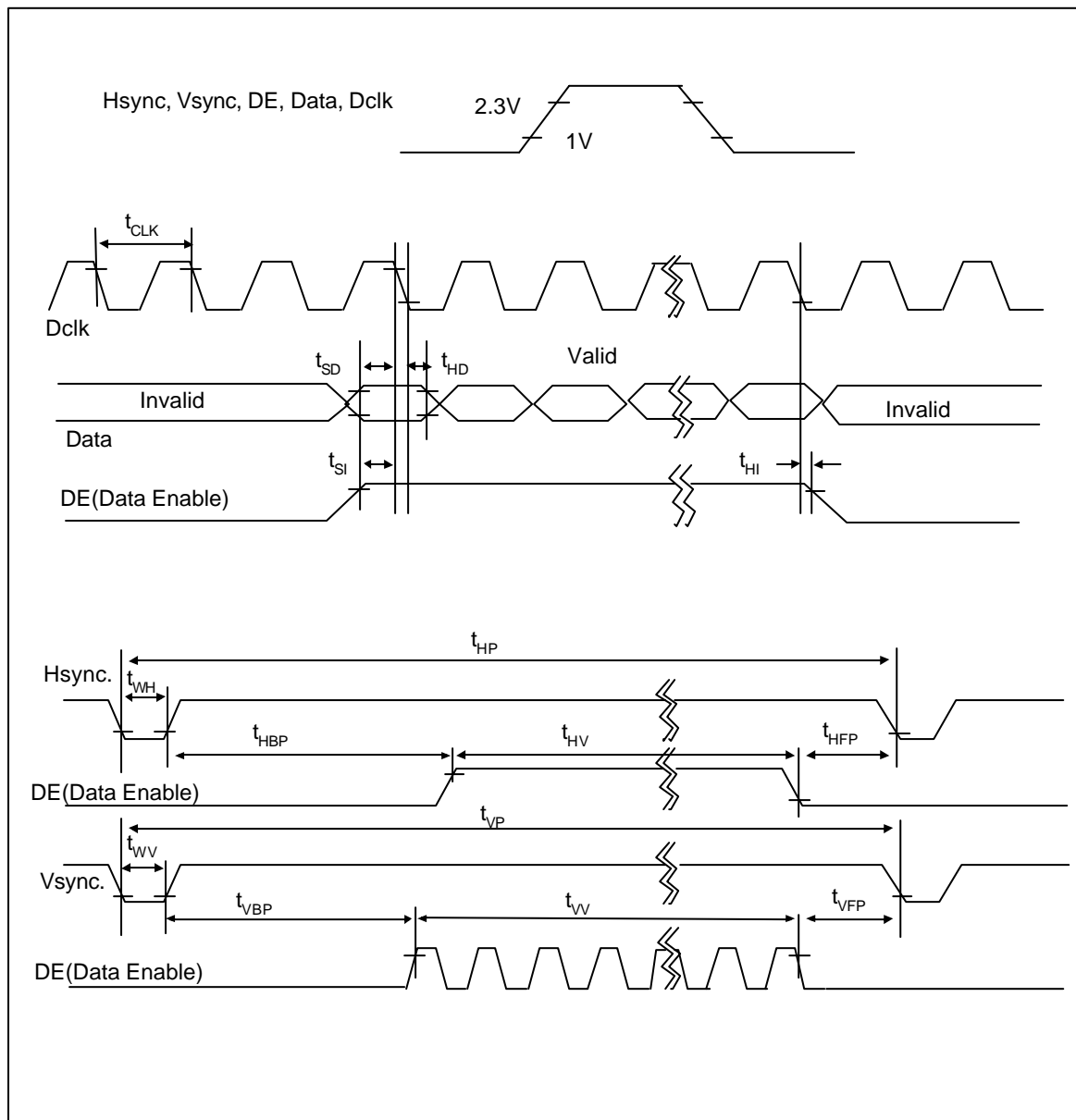

[ Figure 6 ] Signal timing waveforms

**Product Specification**

**3-5. Color Input Data Reference**

The brightness of each primary color(red,green and blue) is based on the 8-bit gray scale data input for the color ; the higher the binary input, the brighter the color. The table below provides a reference for color versus data input.

**Table 8. Color data reference**

| Color        | Input color data |    |    |    |     |    |    |    |       |    |    |    |     |    |    |    |      |    |    |    |     |    |    |    |
|--------------|------------------|----|----|----|-----|----|----|----|-------|----|----|----|-----|----|----|----|------|----|----|----|-----|----|----|----|
|              | Red              |    |    |    |     |    |    |    | Green |    |    |    |     |    |    |    | Blue |    |    |    |     |    |    |    |
|              | MSB              |    |    |    | LSB |    |    |    | MSB   |    |    |    | LSB |    |    |    | MSB  |    |    |    | LSB |    |    |    |
|              | R7               | R6 | R5 | R4 | R3  | R2 | R1 | R0 | G7    | G6 | G5 | G4 | G3  | G2 | G1 | G0 | B7   | B6 | B5 | B4 | B3  | B2 | B1 | B0 |
| Basic colors | Black            | 0  | 0  | 0  | 0   | 0  | 0  | 0  | 0     | 0  | 0  | 0  | 0   | 0  | 0  | 0  | 0    | 0  | 0  | 0  | 0   | 0  | 0  | 0  |
|              | Red(255)         | 1  | 1  | 1  | 1   | 1  | 1  | 1  | 0     | 0  | 0  | 0  | 0   | 0  | 0  | 0  | 0    | 0  | 0  | 0  | 0   | 0  | 0  | 0  |
|              | Green(255)       | 0  | 0  | 0  | 0   | 0  | 0  | 0  | 0     | 1  | 1  | 1  | 1   | 1  | 1  | 1  | 0    | 0  | 0  | 0  | 0   | 0  | 0  | 0  |
|              | Blue(255)        | 0  | 0  | 0  | 0   | 0  | 0  | 0  | 0     | 0  | 0  | 0  | 0   | 0  | 0  | 0  | 0    | 1  | 1  | 1  | 1   | 1  | 1  | 1  |
|              | Cyan             | 0  | 0  | 0  | 0   | 0  | 0  | 0  | 0     | 1  | 1  | 1  | 1   | 1  | 1  | 1  | 1    | 1  | 1  | 1  | 1   | 1  | 1  | 1  |
|              | Magenta          | 1  | 1  | 1  | 1   | 1  | 1  | 1  | 0     | 0  | 0  | 0  | 0   | 0  | 0  | 0  | 0    | 1  | 1  | 1  | 1   | 1  | 1  | 1  |
|              | Yellow           | 1  | 1  | 1  | 1   | 1  | 1  | 1  | 1     | 1  | 1  | 1  | 1   | 1  | 1  | 1  | 0    | 0  | 0  | 0  | 0   | 0  | 0  | 0  |
|              | White            | 1  | 1  | 1  | 1   | 1  | 1  | 1  | 1     | 1  | 1  | 1  | 1   | 1  | 1  | 1  | 1    | 1  | 1  | 1  | 1   | 1  | 1  | 1  |
| Red          | Red(000) dark    | 0  | 0  | 0  | 0   | 0  | 0  | 0  | 0     | 0  | 0  | 0  | 0   | 0  | 0  | 0  | 0    | 0  | 0  | 0  | 0   | 0  | 0  |    |
|              | Red(001)         | 0  | 0  | 0  | 0   | 0  | 0  | 1  | 0     | 0  | 0  | 0  | 0   | 0  | 0  | 0  | 0    | 0  | 0  | 0  | 0   | 0  | 0  |    |
|              | Red(002)         | 0  | 0  | 0  | 0   | 0  | 0  | 1  | 0     | 0  | 0  | 0  | 0   | 0  | 0  | 0  | 0    | 0  | 0  | 0  | 0   | 0  | 0  |    |
|              | :                | :  | :  | :  | :   | :  | :  | :  | :     | :  | :  | :  | :   | :  | :  | :  | :    | :  | :  | :  | :   | :  | :  |    |
|              | Red(253)         | 1  | 1  | 1  | 1   | 1  | 1  | 0  | 1     | 0  | 0  | 0  | 0   | 0  | 0  | 0  | 0    | 0  | 0  | 0  | 0   | 0  | 0  |    |
|              | Red(254)         | 1  | 1  | 1  | 1   | 1  | 1  | 1  | 0     | 0  | 0  | 0  | 0   | 0  | 0  | 0  | 0    | 0  | 0  | 0  | 0   | 0  | 0  |    |
|              | Red(255) bright  | 1  | 1  | 1  | 1   | 1  | 1  | 1  | 1     | 0  | 0  | 0  | 0   | 0  | 0  | 0  | 0    | 0  | 0  | 0  | 0   | 0  | 0  |    |
| Green        | Green(000)dark   | 0  | 0  | 0  | 0   | 0  | 0  | 0  | 0     | 0  | 0  | 0  | 0   | 0  | 0  | 0  | 0    | 0  | 0  | 0  | 0   | 0  | 0  |    |
|              | Green(001)       | 0  | 0  | 0  | 0   | 0  | 0  | 0  | 0     | 0  | 0  | 0  | 0   | 0  | 0  | 1  | 0    | 0  | 0  | 0  | 0   | 0  | 0  |    |
|              | Green(002)       | 0  | 0  | 0  | 0   | 0  | 0  | 0  | 0     | 0  | 0  | 0  | 0   | 0  | 1  | 0  | 0    | 0  | 0  | 0  | 0   | 0  | 0  |    |
|              | :                | :  | :  | :  | :   | :  | :  | :  | :     | :  | :  | :  | :   | :  | :  | :  | :    | :  | :  | :  | :   | :  | :  |    |
|              | Green(253)       | 0  | 0  | 0  | 0   | 0  | 0  | 0  | 0     | 1  | 1  | 1  | 1   | 1  | 1  | 0  | 1    | 0  | 0  | 0  | 0   | 0  | 0  |    |
|              | Green(254)       | 0  | 0  | 0  | 0   | 0  | 0  | 0  | 0     | 1  | 1  | 1  | 1   | 1  | 1  | 1  | 0    | 0  | 0  | 0  | 0   | 0  | 0  |    |
|              | Green(255)bright | 0  | 0  | 0  | 0   | 0  | 0  | 0  | 0     | 1  | 1  | 1  | 1   | 1  | 1  | 1  | 1    | 0  | 0  | 0  | 0   | 0  | 0  |    |
| Blue         | Blue(000) dark   | 0  | 0  | 0  | 0   | 0  | 0  | 0  | 0     | 0  | 0  | 0  | 0   | 0  | 0  | 0  | 0    | 0  | 0  | 0  | 0   | 0  | 0  |    |
|              | Blue(001)        | 0  | 0  | 0  | 0   | 0  | 0  | 0  | 0     | 0  | 0  | 0  | 0   | 0  | 0  | 0  | 0    | 0  | 0  | 0  | 0   | 0  | 1  |    |
|              | Blue(002)        | 0  | 0  | 0  | 0   | 0  | 0  | 0  | 0     | 0  | 0  | 0  | 0   | 0  | 0  | 0  | 0    | 0  | 0  | 0  | 0   | 0  | 1  |    |
|              | :                | :  | :  | :  | :   | :  | :  | :  | :     | :  | :  | :  | :   | :  | :  | :  | :    | :  | :  | :  | :   | :  | :  |    |
|              | Blue(253)        | 0  | 0  | 0  | 0   | 0  | 0  | 0  | 0     | 0  | 0  | 0  | 0   | 0  | 0  | 0  | 0    | 1  | 1  | 1  | 1   | 1  | 1  |    |
|              | Blue(254)        | 0  | 0  | 0  | 0   | 0  | 0  | 0  | 0     | 0  | 0  | 0  | 0   | 0  | 0  | 0  | 0    | 1  | 1  | 1  | 1   | 1  | 1  |    |
|              | Blue(255) bright | 0  | 0  | 0  | 0   | 0  | 0  | 0  | 0     | 0  | 0  | 0  | 0   | 0  | 0  | 0  | 0    | 1  | 1  | 1  | 1   | 1  | 1  |    |

**Product Specification**

**3-6. Power Sequence**

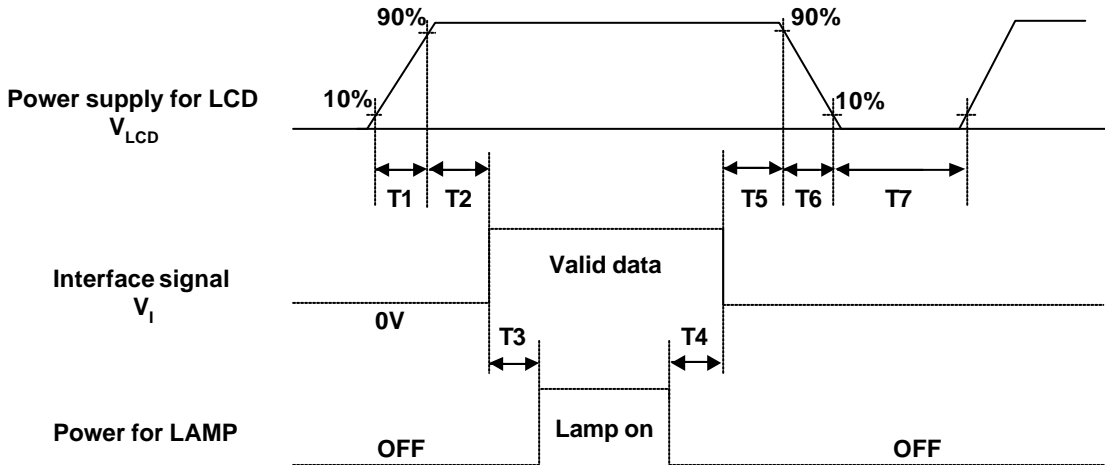

[ Figure 7 ] Power sequence

**Table 9. Power sequence time delay**

| Parameter | Values |      |      | Units |
|-----------|--------|------|------|-------|
|           | Min.   | Typ. | Max. |       |
| $T_1$     | -      | -    | 10   | ms    |
| $T_2$     | 0.01   | -    | 50   | ms    |
| $T_3$     | 200    | -    | -    | ms    |
| $T_4$     | 150    | -    | -    | ms    |
| $T_5$     | 0.01   | -    | 50   | ms    |
| $T_6$     | 0.01   | -    | 100  | ms    |
| $T_7$     | 1      | -    | -    | s     |

- Notes :
1. Please avoid floating state of interface signal at invalid period.
  2. When the interface signal is invalid, be sure to pull down the power supply for LCD  $V_{LCD}$  to 0V.
  3. Lamp power must be turn on after power supply for LCD and interface signals are valid.



**Product Specification**

**4. Optical Specifications**

Optical characteristics are determined after the unit has been 'ON' and stable for approximately 30 minutes in a dark environment at 25 °C. The values specified are measured at an approximate distance 50cm from the LCD surface at a viewing angle of  $\Phi$  and  $\theta$  equal to 0°.

Figure. 9 presents additional information concerning the measurement equipment and method.

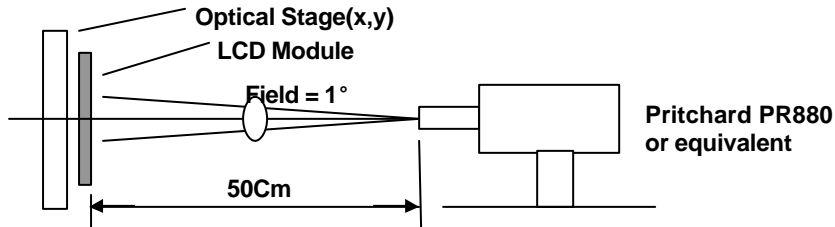

[Figure 9] Optical characteristic measurement equipment and method

**Table 10. Optical characteristics** (Ta=25 °C, V<sub>LCD</sub>=12.0V, f<sub>v</sub>=60Hz Dclk=54MHz, I<sub>BL</sub>=7.5mArms)

| Parameter                | Symbol               | Values |       |       | Units             | Notes |
|--------------------------|----------------------|--------|-------|-------|-------------------|-------|
|                          |                      | Min.   | Typ.  | Max.  |                   |       |
| Contrast ratio           | CR                   | 500    | 800   | -     |                   | 1     |
| Surface luminance, white | L <sub>WH</sub>      | 220    | 270   | -     | cd/m <sup>2</sup> | 2     |
| Luminance uniformity     | $\delta_{WHITE}$     | -      | -     | 1.28  | %                 | 3     |
| Response time            | T <sub>r</sub>       | -      | 18    | 30    | ms                | 4     |
| Rise time                | T <sub>rR</sub>      | -      | 7     | 12    |                   |       |
| Decay time               | T <sub>rD</sub>      | -      | 11    | 18    |                   |       |
| Gray to Gray             | T <sub>GTG_AVG</sub> | -      | 14    | -     | ms                | 5     |
|                          | T <sub>GTG_MAX</sub> | -      | 22    | -     | ms                |       |
| CIE color coordinates    | XR                   | 0.610  | 0.640 | 0.670 |                   |       |
| Red                      | YR                   | 0.314  | 0.344 | 0.374 |                   |       |
|                          | XG                   | 0.260  | 0.290 | 0.320 |                   |       |
| Green                    | YG                   | 0.578  | 0.608 | 0.638 |                   |       |
|                          | XB                   | 0.115  | 0.145 | 0.175 |                   |       |
| Blue                     | YB                   | 0.044  | 0.074 | 0.104 |                   |       |
|                          | XW                   | 0.283  | 0.313 | 0.343 |                   |       |
| White                    | YW                   | 0.299  | 0.329 | 0.359 |                   |       |
| Color Shift              |                      |        |       |       | degree            | 6     |
| Horizontal               | $\theta_{CST\_H}$    | -      | 178   | -     |                   |       |
| Vertical                 | $\theta_{CST\_V}$    | -      | 178   | -     |                   |       |
| Viewing angle            |                      |        |       |       | degree            |       |
| General                  |                      |        |       |       |                   | 7     |
| Horizontal               | $\theta_H$           | 170    | 178   | -     |                   |       |
| Vertical                 | $\theta_V$           | 170    | 178   | -     |                   |       |
| Effective                |                      |        |       |       |                   | 8     |
| Horizontal               | $\theta_{GMA\_H}$    | 170    | 178   | -     |                   |       |
| Vertical                 | $\theta_{GMA\_V}$    | 170    | 178   | -     |                   |       |
| Gray scale               |                      |        | -     | -     |                   | 9     |

**Product Specification**

Notes :

1. Contrast ratio(CR) is defined mathematically as :  

$$\text{Contrast ratio} = \frac{\text{Surface luminance with all white pixels}}{\text{Surface luminance with all black pixels}}$$
 It is measured at center point.

2. Average Luminance ( $L_{WH}$ ) is luminance value at location P1 with all pixels displaying white

3. The variation in surface luminance, d WHITE is defined as

$$d \text{ WHITE} = \frac{\text{Maximum (P1, P2,P3 ....P5)}}{\text{Minimum (P1,P2,P3,...P5)}}$$

Where P1 to P5 are the luminance with all pixels displaying white at 5 locations.

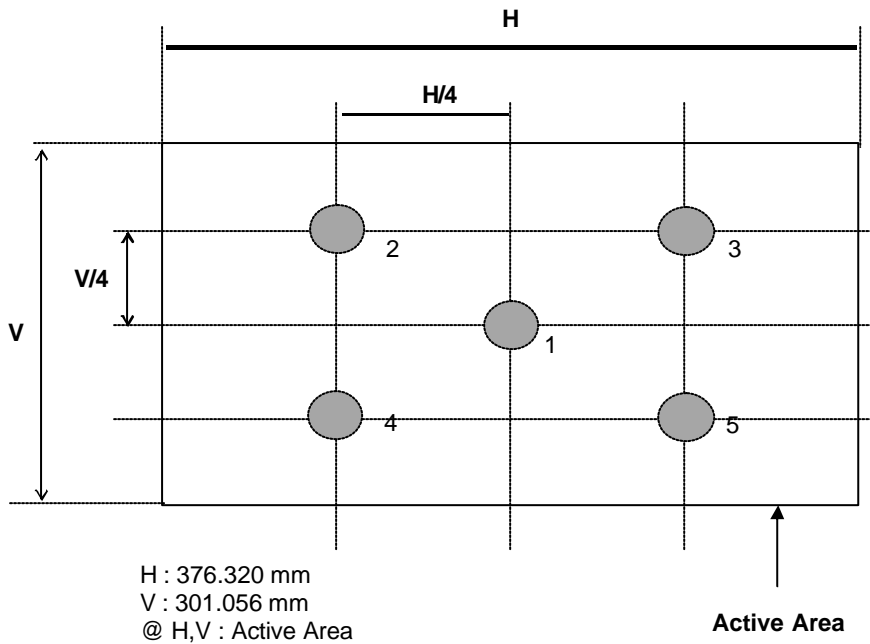

**Product Specification**

Notes :

4. **The response time** is defined as the following figure and shall be measured by switching the input signal for "black" and "white".  
Response time is the time required for the display to transition from black to white (Rise Time,  $T_{rR}$ ) and from white to black (Decay Time,  $T_{rD}$ ).

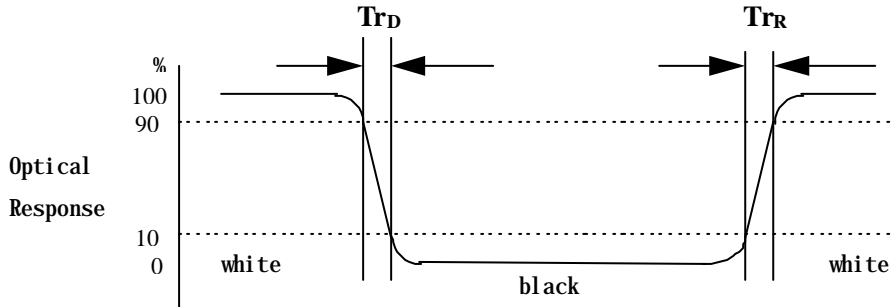

5. **The Gray to Gray response time** is defined as the following figure and shall be measured by switching the input signal for "Gray To Gray".
- Gray step : 5 Step
  - $T_{GTG\_AVR}$  is the total average time at rising time and falling time for "Gray To Gray".
  - $T_{GTG\_MAX}$  is the max time at rising time or falling time for "Gray To Gray".

| Gray to Gray |      | Rising Time |      |      |     |    |
|--------------|------|-------------|------|------|-----|----|
|              |      | G255        | G191 | G127 | G63 | G0 |
| Falling Time | G255 |             |      |      |     |    |
|              | G191 |             |      |      |     |    |
|              | G127 |             |      |      |     |    |
|              | G63  |             |      |      |     |    |
|              | G0   |             |      |      |     |    |

**Product Specification**

6. **Color shift** is the angle at which the color difference is lower than 0.04.

- Color difference(? u'v')

$$u' = \frac{4x}{-2x + 12y + 3}$$

$$v' = \frac{9y}{-2x + 12y + 3}$$

$$? u'v' = \sqrt{(u'_1 - u'_2)^2 + (v'_1 - v'_2)^2}$$

u'1, v'1 : u'v' value at viewing angle direction

u'2, v'2 : u'v' value at front(? =0)

- Pattern size : 25% Box size

- Viewing angle direction of color shift : Horizontal, Vertical

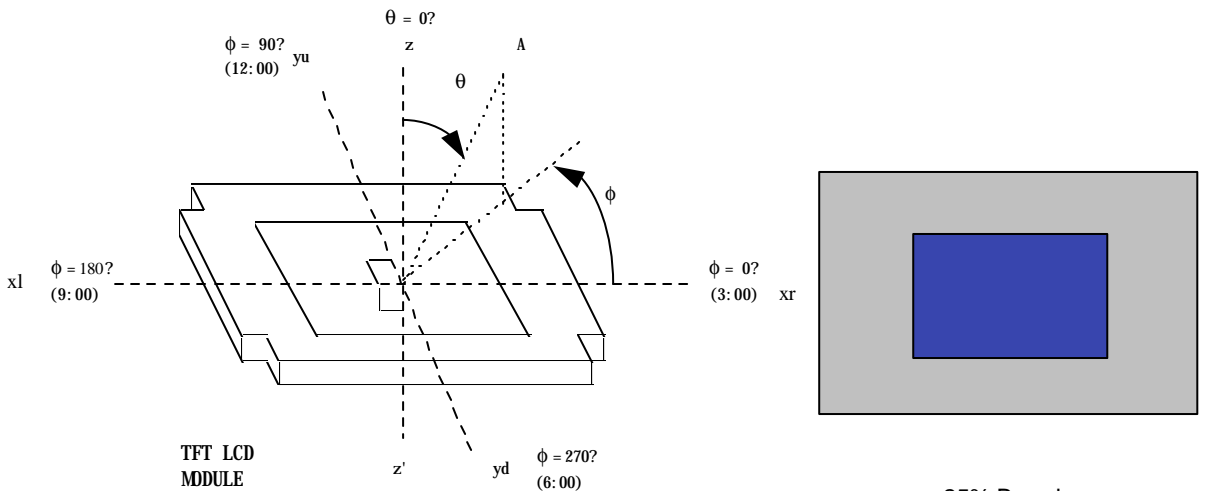

AVERAGE RGB VALUES IN BRUCE RGB FOR MACBETH CHART

|   |                  |                      |                     |                  |                     |                      |
|---|------------------|----------------------|---------------------|------------------|---------------------|----------------------|
|   | <b>dark skin</b> | <b>light skin</b>    | <b>blue sky</b>     | <b>follage</b>   | <b>blue flower</b>  | <b>bluish green</b>  |
| R | 98               | 206                  | 85                  | 77               | 129                 | 114                  |
| G | 56               | 142                  | 112                 | 102              | 118                 | 199                  |
| B | 45               | 123                  | 161                 | 46               | 185                 | 178                  |
|   | <b>orange</b>    | <b>purplish blue</b> | <b>moderate red</b> | <b>purple</b>    | <b>yellow green</b> | <b>orange yellow</b> |
| R | 219              | 56                   | 211                 | 76               | 160                 | 230                  |
| G | 104              | 69                   | 67                  | 39               | 193                 | 162                  |
| B | 24               | 174                  | 87                  | 86               | 58                  | 29                   |
|   | <b>blue</b>      | <b>green</b>         | <b>red</b>          | <b>yellow</b>    | <b>magenta</b>      | <b>cyan</b>          |
| R | 26               | 72                   | 197                 | 241              | 207                 | 35                   |
| G | 32               | 148                  | 27                  | 212              | 62                  | 126                  |
| B | 145              | 65                   | 37                  | 36               | 151                 | 172                  |
|   | <b>white</b>     | <b>neutral 8</b>     | <b>neutral 6.5</b>  | <b>neutral 5</b> | <b>neutral 3.5</b>  | <b>black</b>         |
| R | 240              | 206                  | 155                 | 110              | 63                  | 22                   |
| G | 240              | 206                  | 155                 | 110              | 63                  | 22                   |
| B | 240              | 206                  | 155                 | 110              | 63                  | 22                   |

( Test Pattern : Macbeth Chart )

**Product Specification**

7. **Viewing angle(general)** is the angle at which the contrast ratio is greater than 10.

8. **Effective viewing angle** is the angle at which the gamma shift of gray scale is lower than 0.3.

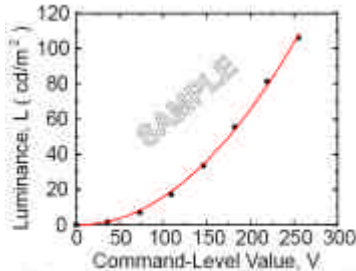

Fig. 1. Sample Luminance vs. gray scale using a 256 bit gray scale.

$$L = aV^r + L_b$$

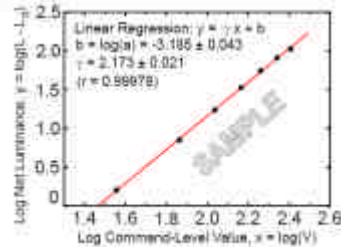

Fig. 2. Sample Log-log plot of luminance vs. gray scale.

$$\log(L - L_b) = r \log(V) + \log(a)$$

Here the Parameter a and r relate the signal level V to the luminance L.

The GAMMA we calculate from the log-log representation (Fig. 2)

9. Grayscale Specification

| Gray Level | Relative Luminance [%] (Typ.) |
|------------|-------------------------------|
| 0          | 0.17                          |
| 31         | 1.41                          |
| 63         | 5.59                          |
| 95         | 14.2                          |
| 127        | 24.7                          |
| 159        | 38.4                          |
| 191        | 55.3                          |
| 223        | 78.9                          |
| 255        | 100                           |

**Product Specification**

**5. Mechanical Characteristics**

Table 11. provides general mechanical characteristics for the model LM190E05-SL03. Please refer to Figure 15,16 regarding the detailed mechanical drawing of the LCD.

**Table 12. Mechanical characteristics**

|                     |   |               |
|---------------------|---|---------------|
| Outside dimensions  | Horizontal  | 396.0 ± 0.5mm |
|                     | Vertical  | 324.0 ± 0.5mm |
|                     | Depth   | 20.0 ± 0.5mm  |
| Bezel area          | Horizontal  | 380.3 ± 0.5mm |
|                     | Vertical  | 305.0 ± 0.5mm |
| Active display area | Horizontal  | 376.32mm      |
|                     | Vertical  | 301.06mm      |
| Weight(approximate) | 2,970g(Typ.), 3,120g(Max.)                                      |               |
| Surface Treatment   | Hard coating(3H)<br>Anti-glare treatment of the front polarizer |               |



Product Specification

Figure 15. Rear view

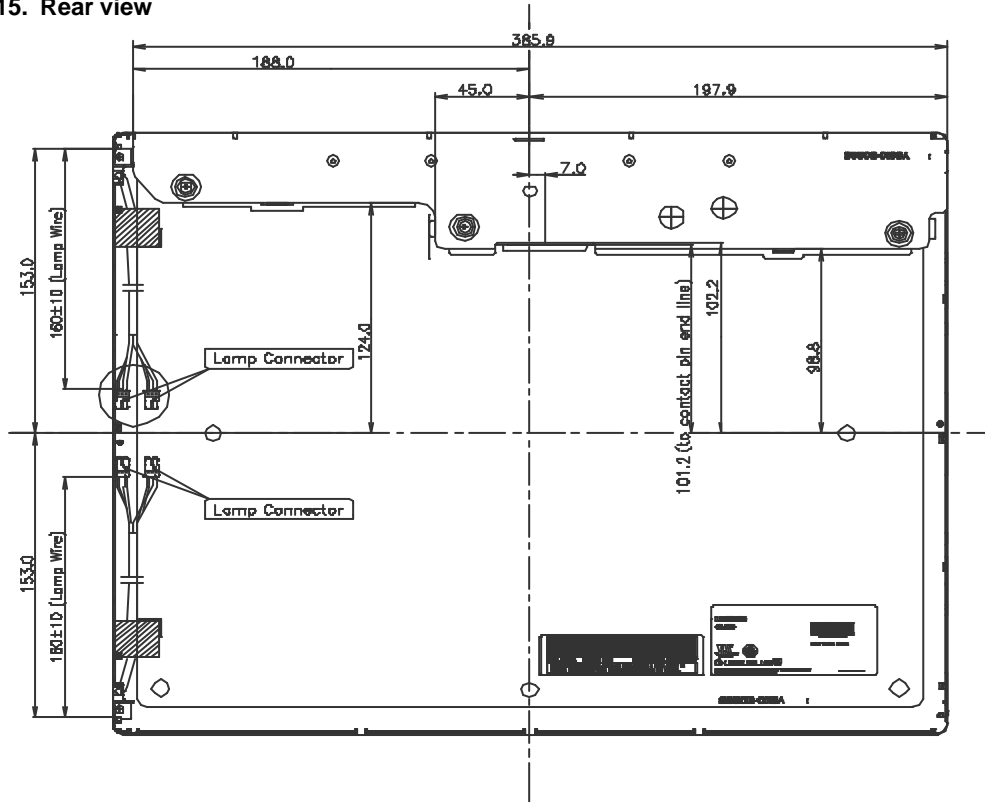

Notes

1. Backlight : 4 Cold Cathode Fluorescent Lamps
2. I/F Connector Specification : GT1 01-30S-H1B(LGC)/IN-30-BA 10(LJU)
3. Lamp Connector Specification - BHSR-02VS-1(JST) or Compatible
4. Torque of user hole : 3.0~4.0kgf-cm
5. Tilt and partial disposition tolerance of display area as following
  - (1) Y-Direction : IA-BI <= 1.0
  - (2) X-Direction : IC-DI <= 1.0

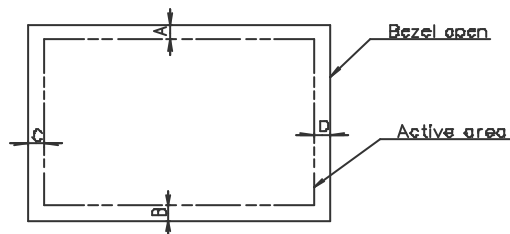

8. Lamp(CCFL) No. is marked at back light connector

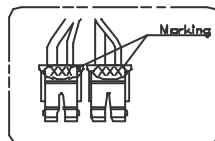

9. Do not wind conductive tape around the backlight wires
10. Unspecified tolerances to be ± 0.5mm



**Product Specification**

**6. Reliability**

**Table 12. Environment test condition**

| No. | Test item                                   | Conditions   |
|-----|---|--|
| 1   | High temperature storage test               | Ta= 60°C 240h  |
| 2   | Low temperature storage test                | Ta= -20°C 240h   |
| 3   | High temperature operation test             | Ta= 50°C 50%RH 240h  |
| 4   | Low temperature operation test              | Ta= 0°C 240h   |
| 5   | Vibration test<br>(non-operating)           | 5 to 200 Hz<br>(Random Wave)<br>14.406 (m/s <sup>2</sup> ) rms<br>Test Time & Vibration Direction<br>33 min X 3 Axis(X, Y, Z-direction) = 99 min |
| 6   | Shock test<br>(non-operating)               | Shock level : 100G<br>Waveform : half sine wave, 2ms<br>Direction : ± X, ± Y, ± Z<br>One time each direction                                     |
| 7   | Altitude<br>storage / shipment<br>operation | 0 - 40,000 feet(12,192m)<br>0 - 10,000 feet(3,048m)  |

{ Result evaluation criteria }

There should be no change which might affect the practical display function when the display quality test is conducted under normal operating condition.

## Product Specification

### 7. International Standards

#### 7-1. Safety

- a) UL 60950, Third Edition, Underwriters Laboratories, Inc., Dated Dec. 11, 2000.  
Standard for Safety of Information Technology Equipment, Including Electrical Business Equipment.
- b) CAN/CSA C22.2, No. 60950, Third Edition, Canadian Standards Association, Dec. 1, 2000.  
Standard for Safety of Information Technology Equipment, Including Electrical Business Equipment.
- c) EN 60950 : 2000, Third Edition  
IEC 60950 : 1999, Third Edition  
European Committee for Electrotechnical Standardization(CENELEC)  
EUROPEAN STANDARD for Safety of Information Technology Equipment Including Electrical Business Equipment.

#### 7-2. EMC

- a) ANSI C63.4 "Methods of Measurement of Radio-Noise Emissions from Low-Voltage Electrical and Electrical Equipment in the Range of 9kHz to 40GHz." American National Standards Institute(ANSI), 1992
- b) C.I.S.P.R "Limits and Methods of Measurement of Radio Interface Characteristics of Information Technology Equipment." International Special Committee on Radio Interference.
- c) EN 55022 "Limits and Methods of Measurement of Radio Interface Characteristics of Information Technology Equipment." European Committee for Electrotechnical Standardization.(CENELEC), 1998 ( Including A1: 2000 )

Notes : The LM190E05-SL03 is applied ROHS

**Product Specification**

**8. Packing**

**8-1. Designation of Lot Mark**

a) Lot Mark



A,B,C : SIZE(INCH)

E : MONTH

G : ASSEMBLY CODE

D : YEAR

F : FACTORY CODE

H ~ M : SERIAL NO.

Note

1. YEAR

|      |      |      |      |      |      |      |      |      |      |      |
|------|------|------|------|------|------|------|------|------|------|------|
| Year | 2001 | 2002 | 2003 | 2004 | 2005 | 2006 | 2007 | 2008 | 2009 | 2010 |
| Mark | 1    | 2    | 3    | 4    | 5    | 6    | 7    | 8    | 9    | 0    |

2. MONTH

|       |     |     |     |     |     |     |     |     |     |     |     |     |
|-------|-----|-----|-----|-----|-----|-----|-----|-----|-----|-----|-----|-----|
| Month | Jan | Feb | Mar | Apr | May | Jun | Jul | Aug | Sep | Oct | Nov | Dec |
| Mark  | 1   | 2   | 3   | 4   | 5   | 6   | 7   | 8   | 9   | A   | B   | C   |

3. FACTORY CODE

|              |          |             |         |
|--------------|----------|-------------|---------|
| Factory Code | LPL Gumi | LPL Nanjing | HEESUNG |
| Mark         | K        | C           | D       |

4. SERIAL NO.

|      |   |
|------|---|
| Mark | 100001~199999, 200001~299999, 300001~399999, ....., A00001~A99999, ....., Z00001~Z99999 |
|------|---|

b) Location of Lot Mark

Serial No. is printed on the label. The label is attached to the backside of the LCD module.  
This is subject to change without prior notice.

**8-2. Packing Form**

a) Package quantity in one box : 6 pcs

b) Box size : 533mm X 310mm X 459mm.

## Product Specification

### 9. Precautions

Please pay attention to the following when you use this TFT LCD module.

#### 9-1. Mounting Precautions

- (1) You must mount a module using holes arranged in four corners or four sides.
- (2) You should consider the mounting structure so that uneven force (ex. twisted stress) is not applied to the module.  
And the case on which a module is mounted should have sufficient strength so that external force is not transmitted directly to the module.
- (3) Please attach a transparent protective plate to the surface in order to protect the polarizer.  
Transparent protective plate should have sufficient strength in order to resist external force.
- (4) You should adopt a mounting structure to satisfy the temperature specification.
- (5) Acetic acid type and chlorine type materials for the cover case are not described because the former generates corrosive gas by attacking the polarizer at high temperature and the latter causes circuit break by electro-chemical reaction.
- (6) Do not touch, push or rub the exposed polarizers with glass, tweezers or anything harder than HB pencil lead. And please do not rub with dust cloths with chemical treatment.  
Do not touch the surface of polarizer for bare hand or greasy cloth. (Some cosmetics are determined to be harmful to the polarizer.)
- (7) When the surface becomes dusty, please wipe gently with absorbent cotton or other soft materials like chamois soaked with petroleum benzene. Normal hexane is recommended for cleaning the adhesives used to attach front / rear polarizers. Do not use acetone, toluene and alcohol because they cause chemical damage to the polarizer.
- (8) Wipe off saliva or water drops as soon as possible. Their long time contact with polarizer causes deformations and color fading.
- (9) Do not open the case because inside circuits do not have sufficient strength.

#### 9-2. Operating Precautions

- (1) The spike noise causes the mis-operation of circuits. It should be lower than following voltage:  
 $V = \pm 200\text{mV}$  (Over and under shoot voltage)
- (2) Response time depends on the temperature. (In lower temperature, it becomes longer.)
- (3) Brightness depends on the temperature. (In lower temperature, it becomes lower.)  
And in lower temperature, response time (required time that brightness is stable after turned on) becomes longer.
- (4) Be careful for condensation at sudden temperature change. Condensation makes damage to polarizer or electrical contacted parts. And after fading condensation, smear or spot will occur.
- (5) When fixed patterns are displayed for a long time, remnant image is likely to occur.
- (6) Module has high frequency circuits. Sufficient suppression to the electromagnetic interference shall be done by system manufacturers. Grounding and shielding methods may be important to minimize the interference.
- (7) Please do not give any mechanical and/or acoustical impact to LCM. Otherwise, LCM can not be operated its full characteristics perfectly.
- (8) A screw which is fastened up the steel should be a machine screw (if not, it causes metal foreign material and deal LCM a fatal blow)
- (9) Please do not set LCD on its edge.

## Product Specification

### 9-3. Electrostatic Discharge Control

Since a module is composed of electronic circuits, it is not strong to electrostatic discharge. Make certain that treatment persons are connected to ground through wrist bard etc. And don't touch interface pin directly.

### 9-4. Precautions for Strong Light Exposure

Strong light exposure causes degradation of polarizer and color filter.

### 9-5. Storage

When storing modules as spares for a long time, the following precautions are necessary.

- (1) Store them in a dark place. Do not expose the module to sunlight or fluorescent light. Keep the temperature between 5°C and 35°C at normal humidity.
- (2) The polarizer surface should not come in contact with any other object.  
It is recommended that they be stored in the container in which they were shipped.

### 9-6. Handling Precautions for Protection Film

- (1) The protection film is attached to the bezel with a small masking tape.  
When the protection film is peeled off, static electricity is generated between the film and polarizer.  
This should be peeled off slowly and carefully by people who are electrically grounded and with well ion-blown equipment or in such a condition, etc.
- (2) When the module with protection film attached is stored for a long time, sometimes there remains a very small amount of glue still on the Bezel after the protection film is peeled off.
- (3) You can remove the glue easily. When the glue remains on the Bezel or its vestige is recognized, please wipe them off with absorbent cotton waste or other soft material like chamois soaked with normal-hexane.