

# PolarHV™ HiPerFET Power MOSFET

**IXFH12N80P**  
**IXFQ12N80P**  
**IXFV12N80P**  
**IXFV12N80PS**

$V_{DSS} = 800 \text{ V}$   
 $I_{D25} = 12 \text{ A}$   
 $R_{DS(on)} \leq 0.85 \text{ } \Omega$   
 $t_{rr} \leq 250 \text{ ns}$

N-Channel Enhancement Mode

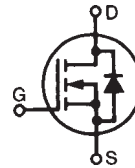

Symbol	Test Conditions	Maximum Ratings	
$V_{DSS}$	$T_J = 25^\circ\text{C to } 150^\circ\text{C}$	800	V
$V_{DGR}$	$T_J = 25^\circ\text{C to } 150^\circ\text{C}; R_{GS} = 1 \text{ M}\Omega$	800	V
$V_{GS}$	Continuous	$\pm 30$	V
$V_{GSM}$	Transient	$\pm 40$	V
$I_{D25}$	$T_C = 25^\circ\text{C}$	12	A
$I_{DM}$	$T_C = 25^\circ\text{C}$ , pulse width limited by $T_{JM}$	36	A
$I_{AR}$	$T_C = 25^\circ\text{C}$	6	A
$E_{AR}$	$T_C = 25^\circ\text{C}$	30	mJ
$E_{AS}$	$T_C = 25^\circ\text{C}$	0.8	J
$dv/dt$	$I_S \leq I_{DM}$ , $di/dt \leq 100 \text{ A}/\mu\text{s}$ , $V_{DD} \leq V_{DSS}$ , $T_J \leq 150^\circ\text{C}$ , $R_G = 5 \text{ } \Omega$	10	V/ns
$P_D$	$T_C = 25^\circ\text{C}$	360	W
$T_J$		-55 ... +150	$^\circ\text{C}$
$T_{JM}$		150	$^\circ\text{C}$
$T_{stg}$		-55 ... +150	$^\circ\text{C}$
$T_L$	1.6 mm (0.062 in.) from case for 10 s	300	$^\circ\text{C}$
$T_{SOLD}$	Plastic body for 10 s	260	$^\circ\text{C}$
$M_d$	Mounting torque (TO-247, TO-3P)	1.13/10	Nm/lb.in.
$F_C$	Mounting force (PLUS220, PLUS220SMD)	11..65/2.5..15	N/lb.
Weight	PLUS220 & PLUS220SMD	4.0	g
	TO-3P	5.5	g
	TO-247	6.0	g

TO-247 (IXFH)

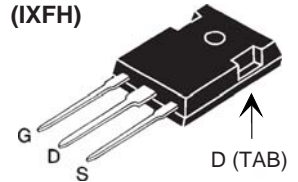

TO-3P (IXFQ)

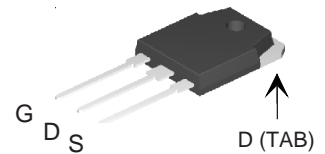

PLUS220 (IXFV)

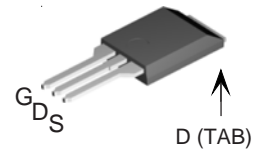

PLUS220 SMD (IXFV...S)

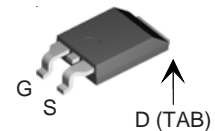

G = Gate      D = Drain  
S = Source    TAB = Drain

## Features

- International standard packages
- Unclamped Inductive Switching (UIS) rated
- Low package inductance
  - easy to drive and to protect

## Advantages

- Easy to mount
- Space savings
- High power density

Symbol	Test Conditions	Characteristic Values		
		Min.	Typ.	Max.
$BV_{DSS}$	$V_{GS} = 0 \text{ V}$ , $I_D = 250 \text{ } \mu\text{A}$	800		V
$V_{GS(th)}$	$V_{DS} = V_{GS}$ , $I_D = 2.5 \text{ mA}$	3.0		5.5 V
$I_{GSS}$	$V_{GS} = \pm 30 \text{ V}$ , $V_{DS} = 0 \text{ V}$			$\pm 100 \text{ nA}$
$I_{DSS}$	$V_{DS} = V_{DSS}$			25 $\mu\text{A}$
	$V_{GS} = 0 \text{ V}$			250 $\mu\text{A}$
$R_{DS(on)}$	$V_{GS} = 10 \text{ V}$ , $I_D = 0.5 I_{D25}$ , Note 1			0.85 $\Omega$

Symbol	Test Conditions	Characteristic Values		
		Min.	Typ.	Max.
( $T_J = 25^\circ\text{C}$ unless otherwise specified)				
$g_{fs}$	$V_{DS} = 20\text{ V}; I_D = 0.5 I_{D25}$ , Note 1	8	14	S
$C_{iss}$	$V_{GS} = 0\text{ V}, V_{DS} = 25\text{ V}, f = 1\text{ MHz}$	2800		pF
$C_{oss}$		210		pF
$C_{rss}$		19		pF
$t_{d(on)}$	$V_{GS} = 10\text{ V}, V_{DS} = 0.5 V_{DSS}, I_D = I_{D25}$ $R_G = 5\ \Omega$ (External)	23		ns
$t_r$		26		ns
$t_{d(off)}$		70		ns
$t_f$		25		ns
$Q_{g(on)}$	$V_{GS} = 10\text{ V}, V_{DS} = 0.5 V_{DSS}, I_D = 0.5 I_{D25}$	51		nC
$Q_{gs}$		13		nC
$Q_{gd}$		19		nC
$R_{thJC}$	(TO-247 & TO-3P)	0.35		$^\circ\text{C/W}$
$R_{thCS}$		0.21		$^\circ\text{C/W}$

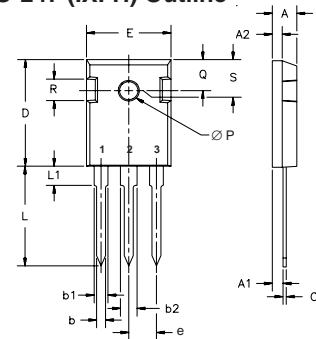
**TO-247 (IXFH) Outline**

 Terminals: 1 - Gate  
 2 - Drain  
 3 - Source  
 Tab - Drain

Dim.	Millimeter		Inches	
	Min.	Max.	Min.	Max.
A	4.7	5.3	.185	.209
A <sub>1</sub>	2.2	2.54	.087	.102
A <sub>2</sub>	2.2	2.6	.059	.098
b	1.0	1.4	.040	.055
b <sub>1</sub>	1.65	2.13	.065	.084
b <sub>2</sub>	2.87	3.12	.113	.123
C	.4	.8	.016	.031
D	20.80	21.46	.819	.845
E	15.75	16.26	.610	.640
e	5.20	5.72	0.205	0.225
L	19.81	20.32	.780	.800
L1		4.50		.177
ØP	3.55	3.65	.140	.144
Q	5.89	6.40	0.232	0.252
R	4.32	5.49	.170	.216
S	6.15	BSC	242	BSC

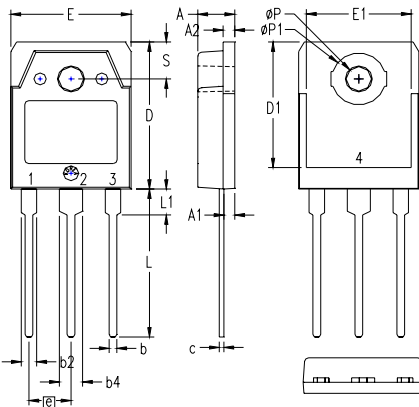
Symbol	Test Conditions	Characteristic Values		
		Min.	Typ.	Max.
( $T_J = 25^\circ\text{C}$ , unless otherwise specified)				
$I_S$	$V_{GS} = 0\text{ V}$			12 A
$I_{SM}$	Repetitive			36 A
$V_{SD}$	$I_F = I_S, V_{GS} = 0\text{ V}$ , Note 1			1.5 V
$t_{rr}$	$I_S = 12\text{ A}, V_{GS} = 0\text{ V}$ $-di/dt = 100\text{ A}/\mu\text{s}, V_R = 100\text{ V}$	200		ns
$Q_{rm}$		0.8		$\mu\text{C}$
$I_{rm}$		4		A

 Note 1: Pulse test,  $t \leq 300\ \mu\text{s}$ , duty cycle  $d \leq 2\%$ 
**TO-3P (IXFQ) Outline**

SYM	INCHES		MILLIMETERS	
	MIN	MAX	MIN	MAX
A	.185	.193	4.70	4.90
A <sub>1</sub>	.051	.059	1.30	1.50
A <sub>2</sub>	.057	.065	1.45	1.65
b	.035	.045	0.90	1.15
b <sub>2</sub>	.075	.087	1.90	2.20
b <sub>4</sub>	.114	.126	2.90	3.20
c	.022	.031	0.55	0.80
D	.780	.799	19.80	20.30
D <sub>1</sub>	.665	.677	16.90	17.20
E	.610	.622	15.50	15.80
E <sub>1</sub>	.531	.539	13.50	13.70
e	.215 BSC		5.45 BSC	
L	.779	.795	19.80	20.20
L <sub>1</sub>	.134	.142	3.40	3.60
ØP	.126	.134	3.20	3.40
ØP <sub>1</sub>	.272	.280	6.90	7.10
S	.193	.201	4.90	5.10

- 1 - GATE
- 2 - DRAIN (COLLECTOR)
- 3 - SOURCE (EMITTER)
- 4 - DRAIN (COLLECTOR)

IXYS reserves the right to change limits, test conditions, and dimensions.

IXYS MOSFETs and IGBTs are covered by one or more of the following U.S. patents:	4,835,592	4,931,844	5,049,961	5,237,481	6,162,665	6,404,065 B1	6,683,344	6,727,585	7,005,734 B2
	4,850,072	5,017,508	5,063,307	5,381,025	6,259,123 B1	6,534,343	6,710,405 B2	6,759,692	7,063,975 B2
	4,881,106	5,034,796	5,187,117	5,486,715	6,306,728 B1	6,583,505	6,710,463	6,771,478 B2	7,071,537

**Fig. 1. Output Characteristics @ 25°C**

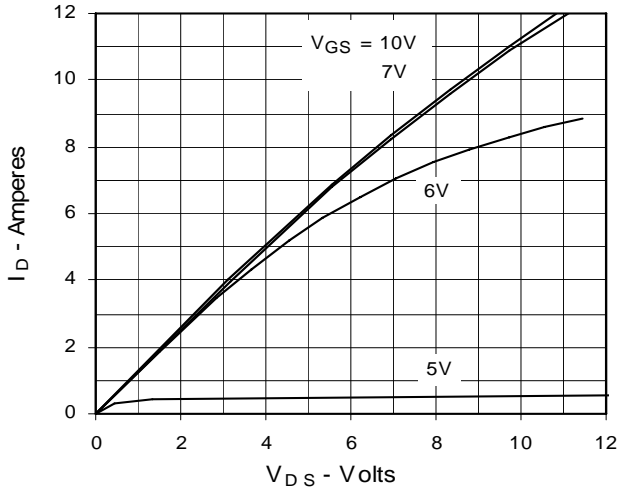

**Fig. 2. Extended Output Characteristics @ 25°C**

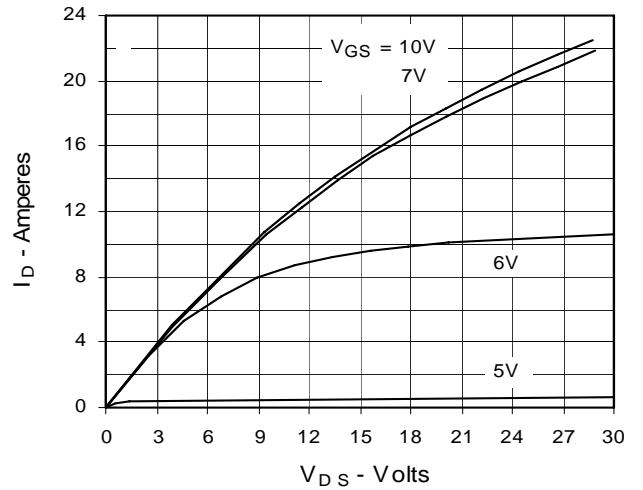

**Fig. 3. Output Characteristics @ 125°C**

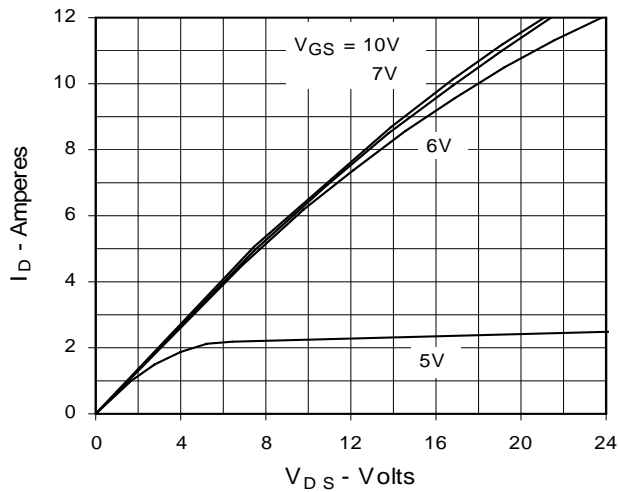

**Fig. 4.  $R_{DS(on)}$  Normalized to 0.5  $I_{D25}$  Value vs. Junction Temperature**

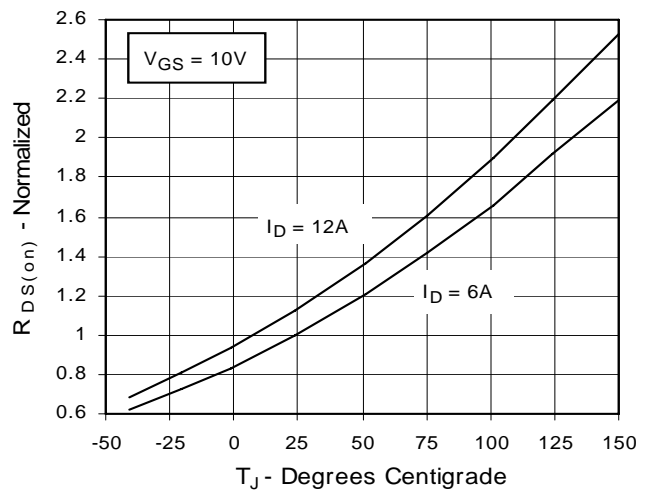

**Fig. 5.  $R_{DS(on)}$  Normalized to 0.5  $I_{D25}$  Value vs.  $I_D$**

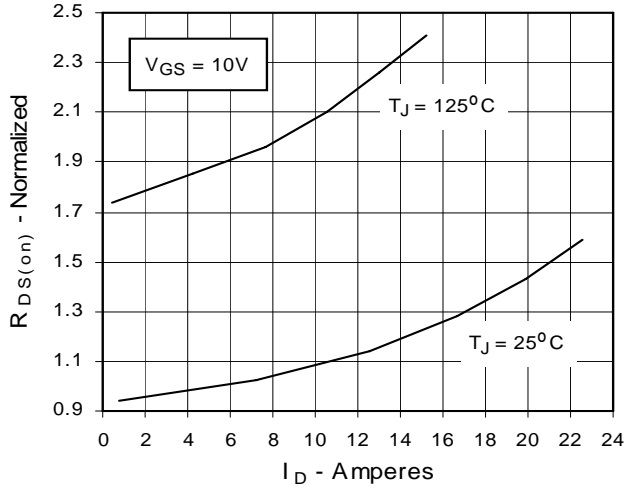

**Fig. 6. Drain Current vs. Case Temperature**

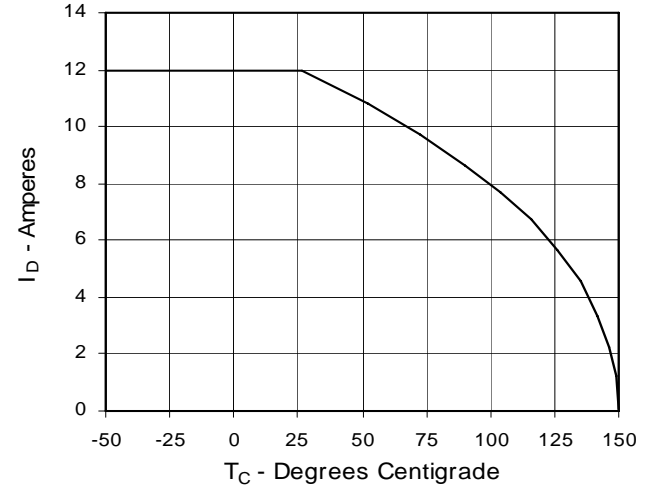

**Fig. 7. Input Admittance**

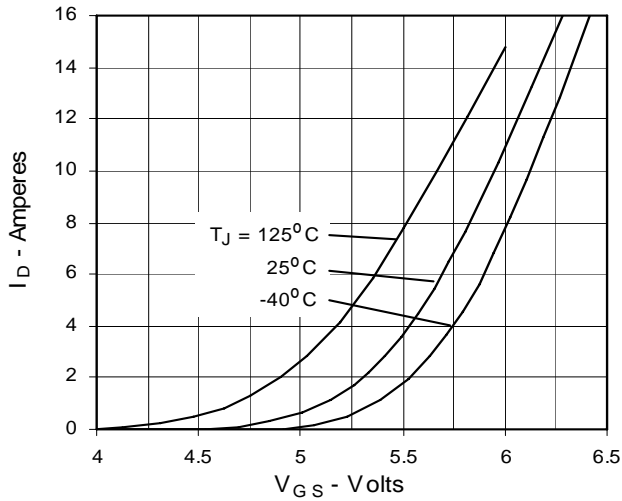

**Fig. 8. Transconductance**

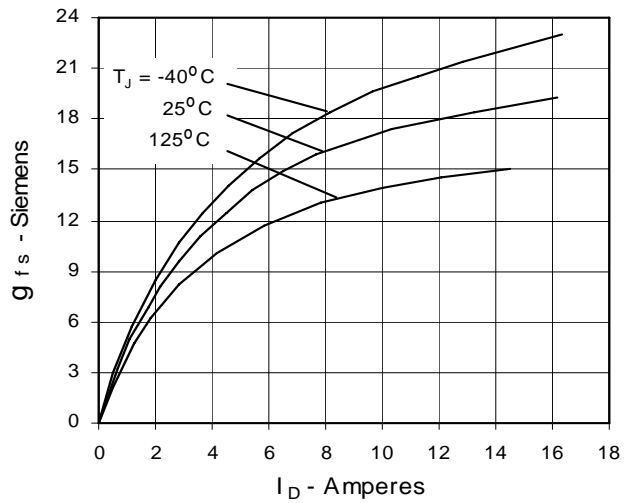

**Fig. 9. Source Current vs. Source-To-Drain Voltage**

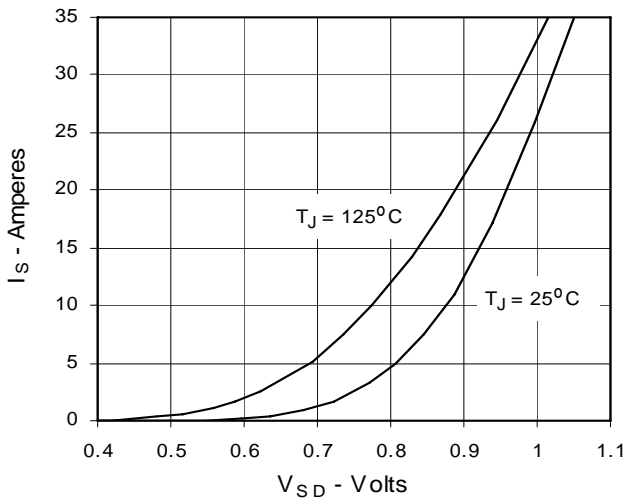

**Fig. 10. Gate Charge**

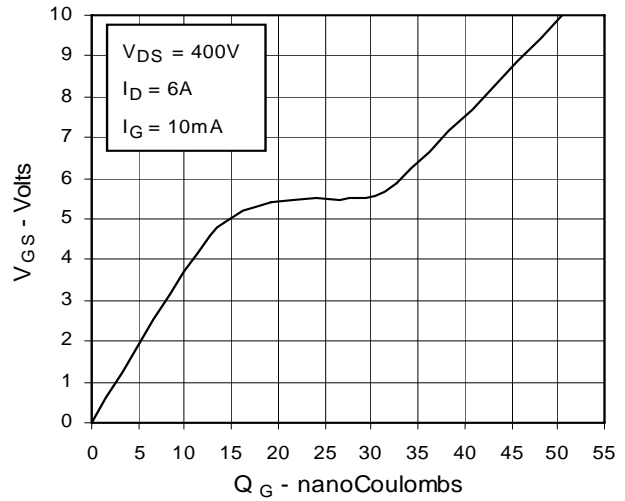

**Fig. 11. Capacitance**

